

Index

Roulements rigides à une rangée de billes	3-2
Roulements à une rangée de billes à contact oblique	3-7
Roulements axial à une rangée de billes	3-8
Roulements rigides à deux rangées de billes	3-10
Roulements à rotule à deux rangées de billes	3-11
Roulements à rotule à bague large	3-13
Roulements à deux rangées de billes à contact oblique	3-14
Roulements à une rangée de rouleaux coniques	3-15
Roulements à une rangée de rouleaux cylindriques	3-19
Roulements à rotule à deux rangées de rouleaux sphériques	3-21
Roulements à une rangée d'aiguille	3-23
Ecrous de serrage et rondelles de frein	3-24
Manchons de serrage	3-25
Paliers autoaligneurs en fonte série UCF/FY	3-27
Paliers autoaligneurs en fonte série UCFL/FYTB	3-28
Paliers autoaligneurs en fonte série UCP/SY	3-29
Paliers autoaligneurs en tôle série PP/P	3-30
Paliers autoaligneurs en tôle série PFL/PFT	3-31
Paliers autoaligneurs en tôle série PFT/PFD	3-32
Paliers autoaligneurs en tôle série PF/PF	3-33
Roulements pour paliers autoaligneurs	3-34
Rotules radiales	3-35
Rotules axiales	3-36

Légende

Pas de suffixe : Ouvert

2Z : Flasqué

2RS : Etanche

NR : A rainure avec segment d'arrêt sur bague extérieure

K : Conique

N : Bague extérieure sans épaulement et bague intérieure à 2 épaulements

NJ : Bague extérieure à 2 épaulements fixes et bague intérieure à 1 épaulement

NU : Bague extérieure à 2 épaulements fixes et bague intérieure sans épaulement

NUP : Bague extérieure à 2 épaulements fixes et bague intérieure à 1 épaulement fixe et 1 épaulement rapporté



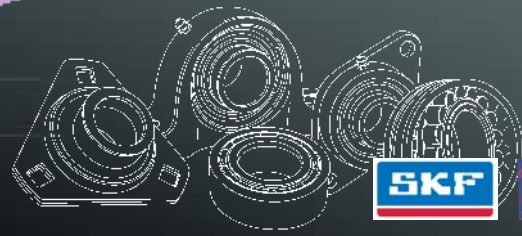

Roulements rigides à une rangée de billes

Pas de suffixe : Ouvert
 2Z : Flasqué
 2RS : Etanche
 NR : A rainure avec segment d'arrêt sur bague extérieure

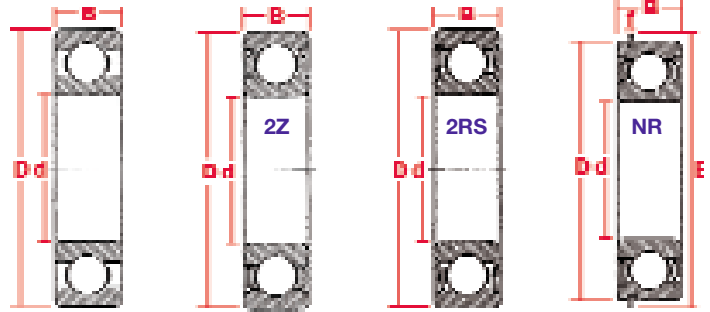

d	D	B	E	f	Série	bepco tractor parts			SKF		
						Ouvert / 2Z	2RS	NR	Ouvert / 2Z	2RS	NR
3	10	4			620	88/623-2Z			58/623-2Z	58/623-2RS	
4	13	5			620	88/624-2Z			58/624-2Z		
	16	5			63	88/634-2Z			58/634-2Z		
5	16	5			620	88/625-2Z	88/625-2RS		58/625-2Z		
	19	6			63	88/635-2Z	88/635-2RS		58/635-2Z		
6	19	6			620	88/626-2Z	88/626-2RS		58/626-2Z	58/626-2RS	
7	19	6			600	88/607-2Z	88/607-2RS		58/607-2Z	58/607-2RS	
	22	7			620	88/627-2Z	88/627-2RS		58/627-2Z	58/627-2RS	
8	22	7			600	88/608-2Z	88/608-2RS		58/608-2Z	58/608-2RS	
	24	8			620	88/628-2Z	88/628-2RS				
9	24	7			600	88/609-2Z	88/609-2RS		58/609-2Z	58/609-2RS	
	26	8			620	88/629-2Z	88/629-2RS		58/629-2Z	58/629-2RS	
10	19	5			618				58/61800-2Z	58/61800-2RS	
	26	8			60	88/6000-2Z	88/6000-2RS		58/6000-2Z	58/6000-2RS	
	26	12			630					58/63000-2RS	
	30	9	34.7	0.70	62	88/6200-2Z	88/6200-2RS		58/6200-2Z	58/6200-2RS	58/6200-2ZNR
	30	14			622					58/62200-2RS	
12	35	11	39.7	1.12	63	88/6300-2Z	88/6300-2RS		58/6300-2Z	58/6300-2RS	
	35	17			623					58/62300-2RS	
	21	5			618	88/6801			58/61801-2Z	58/61801-2RS	
	28	8			60	88/6001-2Z	88/6001-2RS		58/6001-2Z	58/6001-2RS	
	28	12			630					58/63001-2RS	
	32	10	36.7	1.12	62	88/6201-2Z	88/6201-2RS	88/6201-NR	58/6201-2Z	58/6201-2RS	58/6201-2ZNR
	32	14			622					58/62201-2RS	
15	37	12	41.3	1.12	63	88/6301-2Z	88/6301-2RS		58/6301-2Z	58/6301-2RS	
	37	17			623					58/62301-2RS	
	24	5			618	88/6802			58/61802-2Z	58/61802-2RS	
15	32	8			160	88/16002			58/16002-2Z		
	32	9	36.7	0.85	60	88/6002-2Z	88/6002-2RS		58/6002-2Z	58/6002-2RS	
	32	13			630					58/63002-2RS	
	35	11	39.7	1.12	62	88/6202-2Z	88/6202-2RS	88/6202-NR	58/6202-2Z	58/6202-2RS	58/6202-2ZNR
	35	14			622					58/62202-2RS	
	42	13	46.3	1.12	63	88/6302-2Z	88/6302-2RS		58/6302-2Z	58/6302-2RS	
	42	17			623					58/62302-2RS	

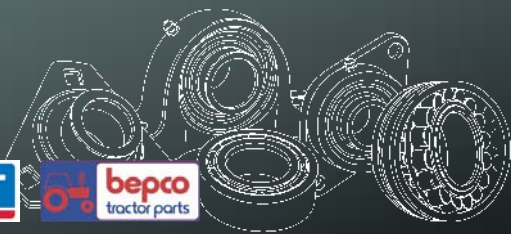

Roulements rigides à une rangée de billes

Pas de suffixe : Ouvert
 2Z : Flasqué
 2RS : Etanche
 NR : A rainure avec segment d'arrêt sur bague extérieure

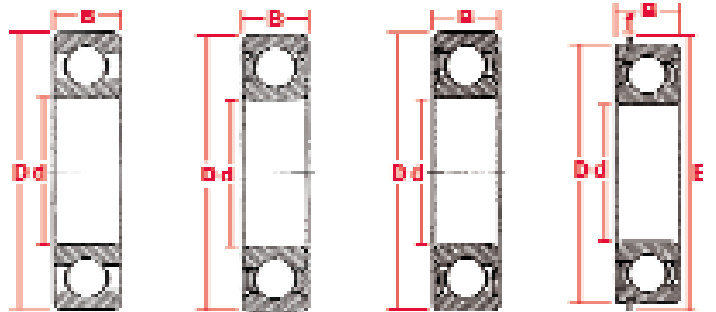

d	D	B	E	f	Série	bepco tractor parts			SKF		
						Ouvert / 2Z	2RS	NR	Ouvert / 2Z	2RS	NR
17	26	5			618	88/6803			58/61803-2Z	58/61803-2RS	
	35	8			160	88/16003			58/16003-2Z		
	35	10	39.7	1.12	60	88/6003-2Z	88/6003-2RS		58/6003-2Z	58/6003-2RS	
	35	14			630					58/63003-2RS	
	40	12	44.6	1.12	62	88/6203-2Z	88/6203-2RS	88/6203-NR	58/6203-2Z	58/6203-2RS	
	40	16			622					58/62203-2RS	
	47	14	52.7	1.12	63	88/6303-2Z	88/6303-2RS	88/6303-NR	58/6303-2Z	58/6303-2RS	
	47	19			623					58/62303-2RS	
	62	17	67.7	1.70	64	88/6403			58/6403		
20	32	7			618	88/6804			58/61804	58/61804-2RS	
	42	8			160	88/16004			58/16004		
	42	12	46.3	1.12	60	88/6004-2Z	88/6004-2RS	88/6004-NR	58/6004-2Z	58/6004-2RS	58/6004-NR
	42	16			630					58/63004-2RS	
	47	14	52.7	1.12	62	88/6204-2Z	88/6204-2RS	88/6204-NR	58/6204-2Z	58/6204-2RS	58/6204-2ZNR
	47	18			622					58/62204-2RS	
	52	15	57.9	1.12	63	88/6304-2Z	88/6304-2RS	88/6304-NR	58/6304-2Z	58/6304-2RS	58/6304-2ZNR
	52	21			623					58/62304-2RS	
	72	19	78.6	1.70	64	88/6404			58/6404		
25	37	7			618	88/6805			58/61805	58/61805-2RS	
	47	8			160	88/16005			58/16005		
	47	12	52.7	1.12	60	88/6005-2Z	88/6005-2RS		58/6005-2Z	58/6005-2RS	58/6005-NR
	47	16			630					58/63005-2RS	
	52	15	57.9	1.12	62	88/6205-2Z	88/6205-2RS	88/6205-NR	58/6205-2Z	58/6205-2RS	58/6205-2ZNR
	52	18			622					58/62205-2RS	
	62	17	67.7	1.70	63	88/6305-2Z	88/6305-2RS	88/6305-NR	58/6305-2Z	58/6305-2RS	58/6305-2ZNR
	62	24			623					58/62305-2RS	
	80	21	86.6	1.70	64	88/6405			58/6405		
30	42	7			618	88/6806			58/61806	58/61806-2RS	
	55	9			160	88/16006			58/16006		
	55	13	60.7	1.12	60	88/6006-2Z	88/6006-2RS	88/6006-NR	58/6006-2Z	58/6006-2RS	
	55	19			630					58/63006-2RS	
	62	16	67.7	1.70	62	88/6206-2Z	88/6206-2RS	88/6206-NR	58/6206-2Z	58/6206-2RS	58/6206-2ZNR
	62	20			622					58/62206-2RS	
	72	19	78.6	1.70	63	88/6306-2Z	88/6306-2RS	88/6306-NR	58/6306-2Z	58/6306-2RS	58/6306-2ZNR
	72	27			623					58/62306-2RS	
	90	23	96.5	2.46	64	88/6406			58/6406		



Roulements rigides à une rangée de billes

Pas de suffixe : Ouvert
 2Z : Flasqué
 2RS : Etanche
 NR : A rainure avec segment d'arrêt sur bague extérieure

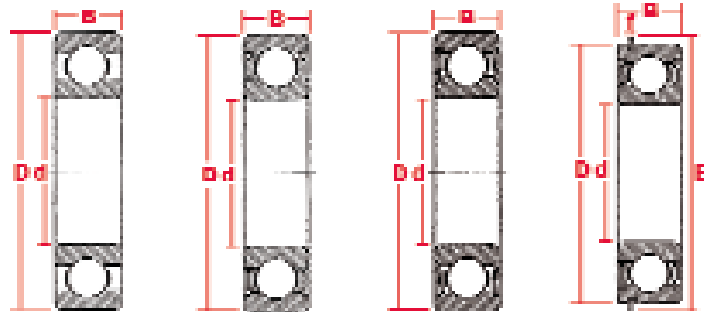

d	D	B	E	f	Série	bepco tractor parts			SKF		
						Ouvert / 2Z	2RS	NR	Ouvert / 2Z	2RS	NR
35	47	7			618	88/6807			58/61807	58/61807-2RS	
	62	9			160	88/16007			58/16007		
	62	14	67.7	1.70	60	88/6007-2Z	88/6007-2RS	88/6007-NR	58/6007-2Z	58/6007-2RS	58/6007-2RSNR
	62	20			630					58/63007-2RS	
	72	17	78.6	1.60	62	88/6207-2Z	88/6207-2RS	88/6207-NR	58/6207-2Z	58/6207-2RS	58/6207-2ZNR
	72	23			622					58/62207-2RS	
	80	21	86.6	1.60	63	88/6307-2Z	88/6307-2RS	88/6307-NR	58/6307-2Z	58/6307-2RS	58/6307-NR
	80	31			623					58/62307-2RS	
40	100	25	106.5	2.46	64	88/6407			58/6407		58/6407-NR
	52	7			618	88/6808			58/61808	58/61808-2RS	
	68	9			160	88/16008			58/16008		
	68	15	74.6	1.70	60	88/6008-2Z	88/6008-2RS		58/6008-2Z	58/6008-2RS	58/6008-NR
	68	21			630					58/63008-2RS	
	80	18	86.6	1.70	62	88/6208-2Z	88/6208-2RS	88/6208-NR	58/6208-2Z	58/6208-2RS	58/6208-2ZNR
	80	23			622					58/62208-2RS	
	90	23	96.5	2.46	63	88/6308-2Z	88/6308-2RS	88/6308-NR	58/6308-2Z	58/6308-2RS	58/6308-NR
45	90	33			623					58/62308-2RS	
	110	27	116.6	2.46	64	88/6408			58/6408		
	58	7			618	88/6809			58/61809	58/61809-2RS	
	75	10			160	88/16009			58/16009		
	75	16	81.6	1.70	60	88/6009-2Z	88/6009-2RS		58/6009-2Z	58/6009-2RS	58/6009-NR
	85	19	91.6	1.70	62	88/6209-2Z	88/6209-2RS	88/6209-NR	58/6209-2Z	58/6209-2RS	58/6209-NR
	85	23			622					58/62209-2RS	
	100	25	106.5	2.46	63	88/6309-2Z	88/6309-2RS	88/6309-NR	58/6309-2Z	58/6309-2RS	58/6309-2ZNR
50	100	36			623					58/62309-2RS	
	120	29	129.7	2.82	64	88/6409			58/6409		58/6409-NR
	65	7			618				58/61810	58/61810-2RS	
	80	10			160	88/16010			58/16010		
	80	16	86.6	1.70	60	88/6010-2Z	88/6010-2RS		58/6010-2Z	58/6010-2RS	
	90	20	96.5	2.46	62	88/6210-2Z	88/6210-2RS	88/6210-NR	58/6210-2Z	58/6210-2RS	58/6210-2ZNR
	90	23			622					58/62210-2RS	
	110	27	116.6	2.46	63	88/6310-2Z	88/6310-2RS	88/6310-NR	58/6310-2Z	58/6310-2RS	58/6310-NR
50	110	40			623					58/62310-2RS	
	130	31	139.7	2.82	64	88/6410			58/6410		58/6410-NR

Roulements

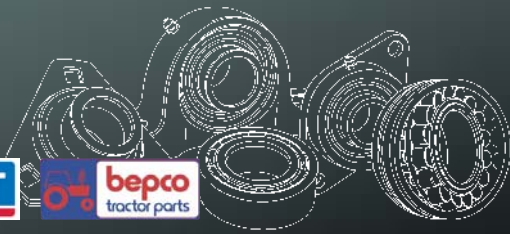

Roulements rigides à une rangée de billes

Pas de suffixe : Ouvert
 2Z : Flasqué
 2RS : Etanche
 NR : A rainure avec segment d'arrêt sur bague extérieure

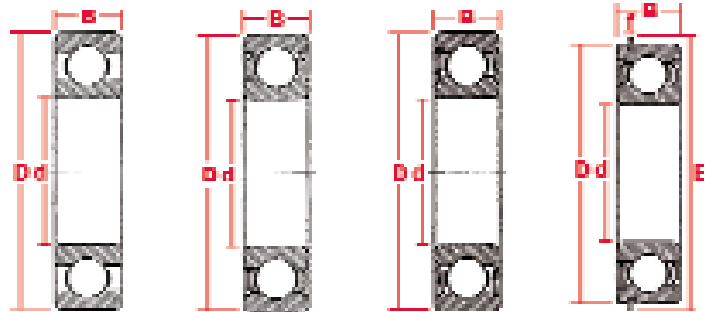

d	D	B	E	f	Série	bepco tractor parts			SKF		
						Ouvert / 2Z	2RS	NR	Ouvert / 2Z	2RS	NR
55	72	9			618				58/61811	58/61811-2RS	
	90	11			160	88/16011			58/16011		
	90	18	96.5	2.46	60	88/6011-2Z	88/6011-2RS		58/6011-2Z	58/6011-2RS	58/6011-NR
	100	21	106.5	2.46	62	88/6211-2Z	88/6211-2RS	88/6211-NR	58/6211-2Z	58/6211-2RS	58/6211-NR
	100	25			622					58/62211-2RS	
	120	29	129.7	2.82	63	88/6311-2Z	88/6311-2RS	88/6311-NR	58/6311-2Z	58/6311-2RS	58/6311-NR
60	78	10			618				58/61812	58/61812-2RS	
	95	11			160	88/16012			58/16012		
	95	18	101.6	2.46	60	88/6012-2Z	88/6012-2RS		58/6012-2Z	58/6012-2RS	58/6012-NR
	110	22	116.6	2.46	62	88/6212-2Z	88/6212-2RS	88/6212-NR	58/6212-2Z	58/6212-2RS	58/6212-2ZNR
	110	28			622					58/62212-2RS	
	130	31	139.7	2.82	63	88/6312-2Z	88/6312-2RS	88/6312-NR	58/6312-2Z	58/6312-2RS	58/6312-NR
65	150	35	159.7	2.82	64	88/6412			58/6412		58/6412-NR
	85	10			618				58/61813	58/61813-2RS	
	100	11			160	88/16013			58/16013		
	100	18	106.5	2.46	60	88/6013-2Z	88/6013-2RS	88/6013-NR	58/6013-2Z	58/6013-2RS	58/6013-NR
	120	23	129.7	2.82	62	88/6213-2Z	88/6213-2RS	88/6213-NR	58/6213-2Z	58/6213-2RS	58/6213-NR
	120	31			622					58/62213-2RS	
70	140	33	149.7	2.82	63	88/6313-2Z	88/6313-2RS	88/6313-NR	58/6313-2Z	58/6313-2RS	58/6313-2ZNR
	160	37	169.7	2.82	64	88/6413		88/6413-NR	58/6413		58/6413-NR
	90	10			618				58/61814	58/61814-2RS	
	110	13			160	88/16014			58/16014		
	110	20	116.6	2.46	60	88/6014-2Z	88/6014-2RS	88/6014-NR	58/6014-2Z	58/6014-2RS	58/6014-NR
	125	24	134.7	2.82	62	88/6214-2Z	88/6214-2RS	88/6214-NR	58/6214-2Z	58/6214-2RS	58/6214-NR
75	150	35	159.7	2.82	63	88/6314-2Z	88/6314-2RS	88/6314-NR	58/6314-2Z	58/6314-2RS	58/6314-NR
	180	42	192.9	3.10	64	88/6414		88/6414-NR	58/6414		
	95	10			618				58/61815	58/61815-2RS	
	115	13			160	88/16015			58/16015		
75	115	20	121.6	2.46	60	88/6015-2Z	88/6015-2RS	88/6015-NR	58/6015-2Z	58/6015-2RS	
	130	25	139.7	2.82	62	88/6215-2Z	88/6215-2RS	88/6215-NR	58/6215-2Z	58/6215-2RS	58/6215-NR
	160	37	169.7	2.82	63	88/6315-2Z	88/6315-2RS		58/6315-2Z	58/6315-2RS	



Roulements rigides à une rangée de billes

Pas de suffixe : Ouvert
 2Z : Flasqué
 2RS : Etanche
 NR : A rainure avec segment d'arrêt sur bague extérieure

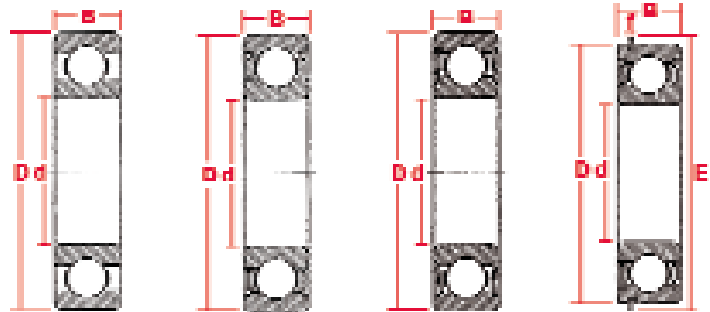

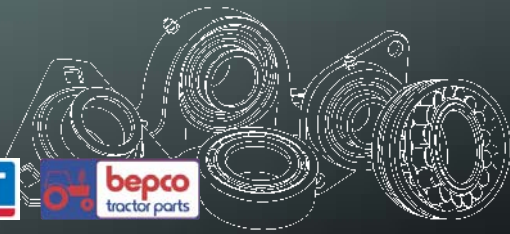

d	D	B	E	f	Série	bepco tractor parts			SKF		
						Ouvert / 2Z	2RS	NR	Ouvert / 2Z	2RS	NR
80	100	10			618				58/61816	58/61816-2RS	
	125	14			160	88/16016			58/16016		
	125	22	134.7	2.82	60	88/6016-2Z	88/6016-2RS		58/6016-2Z	58/6016-2RS	58/6016-NR
	140	26	149.7	2.82	62	88/6216-2Z	88/6216-2RS	88/6216-NR	58/6216-2Z	58/6216-2RS	58/6216-NR
	170	39	182.9	3.10	63	88/6316-2Z	88/6316-2RS		58/6316-2Z	58/6316-2RS	
	200	48	212.9	3.10	64	88/6416			58/6416		
85	110	13			618				58/61817	58/61817-2RS	
	130	14			160				58/16017		
	130	22	139.7	2.82	60	88/6017-2Z		88/6017-NR	58/6017-2Z	58/6017-2RS	58/6017-NR
	150	28	159.7	2.82	62	88/6217-2Z	88/6217-2RS	88/6217-NR	58/6217-2Z	58/6217-2RS	58/6217-NR
	180	41	192.9	3.10	63	88/6317-2Z	88/6317-2RS		58/6317-2Z	58/6317-2RS	
	210	52			64	88/6417			58/6417		
90	115	13			618				58/61818	58/61818-2RS	
	140	16			160				58/16018		
	140	24	149.7	2.82	60	88/6018-2Z			58/6018-2Z	58/6018-2RS	58/6018-NR
	160	30	169.7	2.82	62	88/6218-2Z	88/6218-2RS	88/6218-NR	58/6218-2Z	58/6218-2RS	58/6218-NR
95	145	16			160				58/16019		
	145	24	154.7	2.82	60	88/6019-2Z			58/6019-2Z	58/6019-2RS	
	170	32	182.9	3.10	62	88/6219-2Z	88/6219-2RS		58/6219-2Z	58/6219-2RS	
100	125	13			618				58/61820	58/61820-2RS	
	150	16			160				58/16020		
	150	24	159.7	2.82	60	88/6020-2Z		88/6020-NR	58/6020-2Z	58/6020-2RS	58/6020-NR
	180	34	192.9	3.10	62	88/6220-2Z	88/6220-2RS		58/6220-2Z	58/6220-2RS	
105	130	13			618					58/61821-2RS	
	160	26	169.7	2.82	60	88/6021-2Z			58/6021-2Z	58/6021-2RS	
	190	36	202.9	3.10	62	88/6221-2Z	88/6221-2RS		58/6221-2Z		
110	140	16			618				58/61822	58/61822-2RS	
	170	19			160				58/16022		
	170	28	182.9	3.10	60	88/6022-2Z			58/6022-2Z	58/6022-2RS	
	200	38	212.9	3.10	62				58/6222-2Z		
120	180	19			160				58/16024		
	180	28	192.9	3.10	60	88/6024-2Z		88/6024-NR	58/6024-2Z	58/6024-2RS	
	215	40			62	88/6224-2Z			58/6224		
140	175	18			618				58/61828	58/61828-2RS	
	210	33			60	88/6028-2Z			58/6028-2Z	58/6028-2RS	
150	225	35			60	88/6030-2Z			58/6030-2Z	58/6030-2RS	

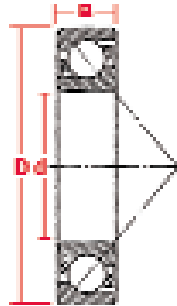

Roulements à une rangée de billes à contact oblique



d	D	B	Série		
10	30	9	72	88/7200B	58/7200BEP
12	32	10	72	88/7201B	58/7201BEP
	37	12	73	88/7301B	58/7301BEP
15	35	11	72	88/7202B	58/7202BEP
	42	13	73	88/7302B	58/7302BEP
17	40	12	72	88/7203B	58/7203BEP
	47	14	73	88/7303B	58/7303BEP
20	47	14	72	88/7204B	58/7204BEP
	52	15	73	88/7304B	58/7304BEP
25	52	15	72	88/7205B	58/7205BEP
	62	17	73	88/7305B	58/7305BEP
30	62	16	72	88/7206B	58/7206BEP
	72	19	73	88/7306B	58/7306BEP
35	72	17	72	88/7207B	58/7207BEP
	80	21	73	88/7307B	58/7307BEP
40	80	18	72	88/7208B	58/7208BEP
	90	23	73	88/7308B	58/7308BEP
45	85	19	72	88/7209B	58/7209BEP
	100	25	73	88/7309B	58/7309BEP
50	90	20	72	88/7210B	58/7210BEP
	110	27	73	88/7310B	58/7310BEP
55	100	21	72	88/7211B	58/7211BEP
	120	29	73	88/7311B	58/7311BEP
60	110	22	72	88/7212B	58/7212BEP
	130	31	73	88/7312B	58/7312BEP
65	120	23	72	88/7213B	58/7213BEP
	140	33	73	88/7313B	58/7313BEP
70	125	24	72	88/7214B	58/7214BEP
	150	35	73	88/7314B	58/7314BEP

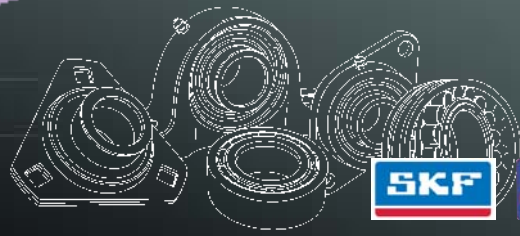

Roulements axial à une rangée de billes

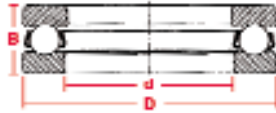

d	D	B	Série	bepco tractor parts	SKF
10	24	9	511	88/51100	58/51100
	26	11	512	88/51200	58/51200
12	26	9	511	88/51101	58/51101
	28	11	512	88/51201	58/51201
15	28	9	511	88/51102	58/51102
	32	12	512	88/51202	58/51202
17	30	9	511	88/51103	58/51103
	35	12	512	88/51203	58/51203
20	35	10	511	88/51104	58/51104
	40	14	512	88/51204	58/51204
25	42	11	511	88/51105	58/51105
	47	15	512	88/51205	58/51205
	52	18	513	88/51305	58/51305
	60	24	514	88/51405	58/51405
30	47	11	511	88/51106	58/51106
	52	16	512	88/51206	58/51206
	60	21	513	88/51306	58/51306
	70	28	514	88/51406	58/51406
35	52	12	511	88/51107	58/51107
	62	18	512	88/51207	58/51207
	68	24	513	88/51307	58/51307
	80	32	514	88/51407	58/51407
40	60	13	511	88/51108	58/51108
	68	19	512	88/51208	58/51208
	78	26	513	88/51308	58/51308
	90	36	514	88/51408	58/51408
45	65	14	511	88/51109	58/51109
	73	20	512	88/51209	58/51209
	85	28	513	88/51309	58/51309
	100	39	514	88/51409	58/51409
50	70	14	511	88/51110	58/51110
	78	22	512	88/51210	58/51210
	95	31	513	88/51310	58/51310
	110	43	514	88/51410	58/51410

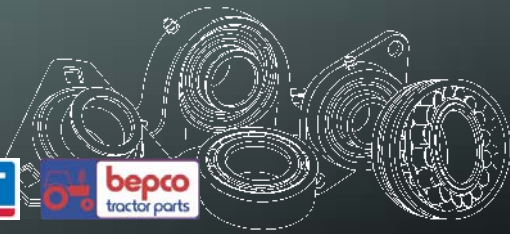

Roulements axial à une rangée de billes



d	D	B	Série	bepco tractor parts	SKF
55	78	16	511	88/51111	58/51111
	90	25	512	88/51211	58/51211
	105	35	513	88/51311	58/51311
	120	48	514	88/51411	58/51411
60	85	17	511	88/51112	58/51112
	95	26	512	88/51212	58/51212
	110	35	513	88/51312	58/51312
	130	51	514	88/51412	58/51412
65	90	18	511	88/51113	58/51113
	100	27	512	88/51213	58/51213
	115	36	513	88/51313	58/51313
	140	56	514	88/51413	58/51413
70	95	18	511	88/51114	58/51114
	105	27	512	88/51214	58/51214
	125	40	513	88/51314	58/51314
	150	60	514	88/51414	58/51414
75	100	19	511	88/51115	58/51115
	110	27	512	88/51215	58/51215
	135	44	513	88/51315	58/51315
	160	65	514	88/51415	58/51415
80	105	19	511	88/51116	58/51116
	115	28	512	88/51216	58/51216
	140	44	513	88/51316	58/51316
	170	68	514	88/51416	58/51416
85	110	19	511	88/51117	58/51117
	125	31	512	88/51217	58/51217
	150	49	513	88/51317	58/51317
	180	72	514	88/51417	58/51417
90	120	22	511	88/51118	58/51118
	135	35	512	88/51218	58/51218
	155	50	513	88/51318	58/51318
	190	77	514	88/51418	58/51418



Roulements rigides à deux rangée de billes

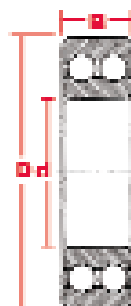

d	D	B	Série	bepco tractor parts	SKF
10	30	14	42	88/4200	58/4200
12	32	14	42	88/4201	58/4201
	37	17	43		58/4301
15	35	14	42	88/4202	58/4202
	42	17	43	88/4302	58/4302
17	40	16	42	88/4203	58/4203
	47	19	43	88/4303	58/4303
20	47	18	42	88/4204	58/4204
	52	21	43	88/4304	58/4304
25	52	18	42	88/4205	58/4205
	62	24	43	88/4305	58/4305
30	62	20	42	88/4206	58/4206
	72	27	43	88/4306	58/4306
35	72	23	42	88/4207	58/4207
	80	31	43	88/4307	58/4307
40	80	23	42	88/4208	58/4208
	90	33	43	88/4308	58/4308
45	85	23	42	88/4209	58/4209
	100	36	43	88/4309	58/4309
50	90	23	42	88/4210	58/4210
	110	40	43	88/4310	58/4310
55	100	25	42	88/4211	58/4211
	120	43	43	88/4311	58/4311
60	110	28	42	88/4212	58/4212
	130	46	42	88/4312	58/4312
65	120	31	42	88/4213	58/4213
	140	48	43	88/4313	
70	125	31	42	88/4214	58/4214
	150	51	43	88/4314	

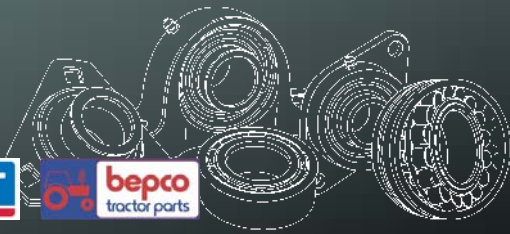

Roulements à rotule à deux rangées de billes



Pas de suffixe : Ouvert
 2RS : Etanche
 K : Conique

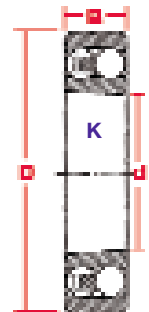
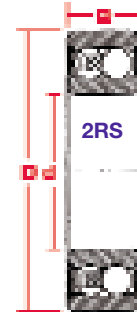
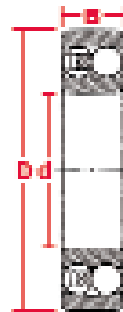

d	D	B	Série	bepco tractor parts			SKF		
				Ouvert	2RS	K	Ouvert	2RS	K
10	30	9	12	88/1200			58/1200		
	30	14	22	88/2200	88/2200-2RS		58/2200	58/2200-2RS	
12	32	10	12	88/1201			58/1201		
	32	14	22	88/2201	88/2201-2RS		58/2201	58/2201-2RS	
	37	12	13	88/1301			58/1301		
	37	17	23	88/2301	88/2301-2RS				
15	35	11	12	88/1202			58/1202		
	35	14	22	88/2202	88/2202-2RS		58/2202	58/2202-2RS	
	42	13	13	88/1302			58/1302		
	42	17	23	88/2302	88/2302-2RS			58/2302-2RS	
17	40	12	12	88/1203			58/1203		
	40	16	22	88/2203	88/2203-2RS		58/2203	58/2203-2RS	
	47	14	13	88/1303			58/1303		
	47	19	23	88/2303	88/2303-2RS			58/2303-2RS	
20	47	14	12	88/1204		88/1204K	58/1204		
	47	18	22	88/2204	88/2204-2RS	88/2204K	58/2204	58/2204-2RS	
	52	15	13	88/1304		88/1304K	58/1304		
	52	21	23	88/2304	88/2304-2RS		58/2304		
25	52	15	12	88/1205		88/1205K	58/1205		
	52	18	22	88/2205	88/2205-2RS	88/2205K	58/2205	58/2205-2RS	58/2205K
	62	17	13	88/1305		88/1305K	58/1305		58/1305K
	62	24	23	88/2305	88/2305-2RS	88/2305K	58/2305	58/2305-2RS	
30	62	16	12	88/1206		88/1206K	58/1206		58/1206K
	62	20	22	88/2206	88/2206-2RS	88/2206K	58/2206	58/2206-2RS	58/2206K
	72	19	13	88/1306		88/1306K	58/1306		58/1306K
	72	27	23	88/2306	88/2306-2RS	88/2306K	58/2306	58/2306-2RS	58/2306K
35	72	17	12	88/1207		88/1207K	58/1207		58/1207K
	72	23	22	88/2207	88/2207-2RS	88/2207K	58/2207	58/2207-2RS	58/2207K
	80	21	13	88/1307		88/1307K	58/1307		58/1307K
	80	31	23	88/2307	88/2307-2RS	88/2307K	58/2307	58/2307-2RS	58/2307K
40	80	18	12	88/1208		88/1208K	58/1208		58/1208K
	80	23	22	88/2208	88/2208-2RS	88/2208K	58/2208	58/2208-2RS	58/2208K
	90	23	13	88/1308		88/1308K	58/1308		58/1308K
	90	33	23	88/2308	88/2308-2RS	88/2308K	58/2308	58/2308-2RS	58/2308K

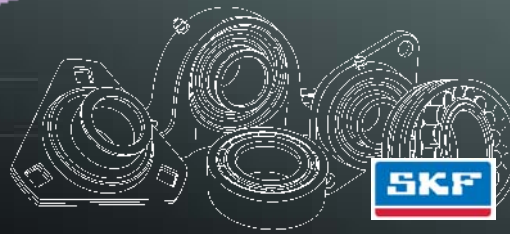

Roulements à rotule à deux rangées de billes



Pas de suffixe : Ouvert
2RS : Etanche
K : Conique

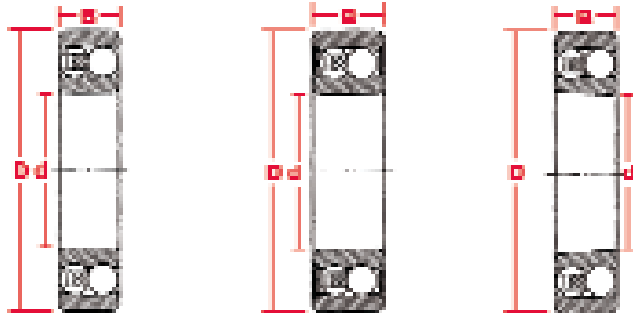

d	D	B	Série	bepco tractor parts			SKF		
				Ouvert	2RS	K	Ouvert	2RS	K
45	85	19	12	88/1209		88/1209K	58/1209		58/1209K
	85	23	22	88/2209	88/2209-2RS	88/2209K	58/2209	58/2209-2RS	58/2209K
	100	25	13	88/1309		88/1309K	58/1309		58/1309K
	100	36	23	88/2309	88/2309-2RS	88/2309K	58/2309	58/2309-2RS	58/2309K
50	90	20	12	88/1210		88/1210K	58/1210		58/1210K
	90	23	22	88/2210	88/2210-2RS	88/2210K	58/2210	58/2210-2RS	58/2210K
	110	27	13	88/1310		88/1310K	58/1310		58/1310K
	110	40	23	88/2310	88/2310-2RS	88/2310K	58/2310	58/2310-2RS	58/2310K
55	100	21	12	88/1211		88/1211K	58/1211		58/1211K
	100	25	22	88/2211		88/2211K	58/2211	58/2211-2RS	58/2211K
	120	29	13	88/1311		88/1311K	58/1311		58/1311K
	120	43	23	88/2311		88/2311K	58/2311		58/2311K
60	110	22	12	88/1212		88/1212K	58/1212		58/1212K
	110	28	22	88/2212	88/2212-2RS	88/2212K	58/2212	58/2212-2RS	58/2212K
	130	31	13	88/1312		88/1312K	58/1312		58/1312K
	130	46	23	88/2312		88/2312K	58/2312		58/2312K
65	120	23	12	88/1213		88/1213K	58/1213		58/1213K
	120	31	22	88/2213		88/2213K	58/2213	58/2213-2RS	58/2213K
	140	33	13	88/1313		88/1313K	58/1313		58/1313K
	140	48	23	88/2313		88/2313K	58/2313		58/2313K
70	125	24	12	88/1214		88/1214K	58/1214		
	125	31	22	88/2214			58/2214	58/2214-2RS	
75	130	25	12	88/1215		88/1215K	58/1215		58/1215K
	130	31	22	88/2215		88/2215K	58/2215		58/2215K
80	140	26	12	88/1216		88/1216K	58/1216		58/1216K
	140	33	22	88/2216		88/2216K	58/2216		58/2216K
85	150	28	12	88/1217		88/1217K	58/1217		58/1217K
	150	36	22	88/2217		88/2217K	58/2217		58/2217K
90	160	30	12	88/1218		88/1218K	58/1218		58/1218K
	160	40	22	88/2218		88/2218K	58/2218		58/2218K
95	170	43	22	88/2219		88/2219K			58/2219K
100	180	46	22	88/2220		88/2220K	58/2220		58/2220K

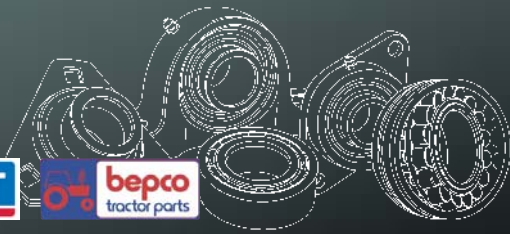

Roulements à rotule à bague large

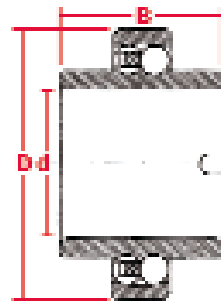

d	D	B	Série	SKF	
				Ouvert	
30	62	48	112	58/11206	
35	72	52	112	58/11207	
40	80	56	112	58/11208	
45	85	58	112	58/11209	
50	90	58	112	58/11210	
60	110	62	112	58/11212	

Roulements



Roulements à deux rangées de billes à contact oblique



Pas de suffixe : Ouvert
 2Z : Flasqué
 2RS : Etanche

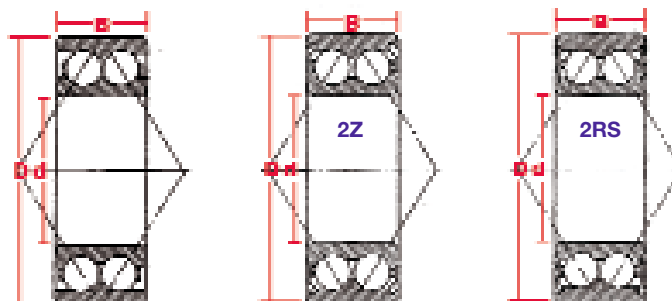

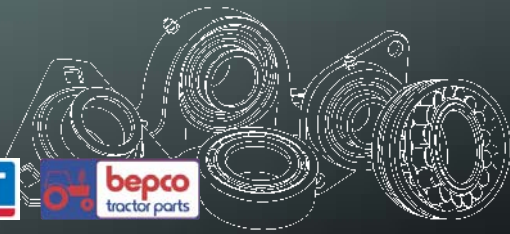

d	D	B	Série	bepco tractor parts		
				Ouvert		
				SKF		
				2Z	2RS	
10	30	14	32	88/3200	58/3200-2Z	58/3200-2RS
12	32	15,9	32	88/3201	58/3201-2Z	58/3201-2RS
15	35	15,9	32	88/3202	58/3202-2Z	58/3202-2RS
	42	19	33	88/3302	58/3302	58/3302-2RS
17	40	17,5	32	88/3203	58/3203-2Z	58/3203-2RS
	47	22,2	33	88/3303	58/3303	58/3303-2RS
20	47	20,6	32	88/3204	58/3204-2Z	58/3204-2RS
	52	22,2	33	88/3304	58/3304	58/3304-2RS
25	52	20,6	32	88/3205	58/3205-2Z	58/3205-2RS
	62	25,4	33	88/3305	58/3305	58/3305-2RS
30	62	23,8	32	88/3206	58/3206-2Z	58/3206-2RS
	72	30,2	33	88/3306	58/3306	58/3306-2RS
35	72	27	32	88/3207	58/3207-2Z	58/3207-2RS
	80	34,9	33	88/3307	58/3307	58/3307-2RS
40	80	30,2	32	88/3208	58/3208-2Z	58/3208-2RS
	90	36,5	33	88/3308	58/3308	58/3308-2RS
45	85	30,2	32	88/3209	58/3209-2Z	58/3209-2RS
	100	39,7	33	88/3309	58/3309	
50	90	30,2	32	88/3210	58/3210	58/3210-2RS
	110	44,4	33	88/3310	58/3310	
55	100	33,3	32	88/3211	58/3211	58/3211-2RS
	120	49,2	33	88/3311	58/3311	
60	110	36,5	32	88/3212	58/3212	
	130	54	33	88/3312	58/3312	
65	120	38,1	32	88/3213	58/3213	
	140	58,7	33	88/3313	58/3313	
70	125	39,7	32	88/3214	58/3214	
	150	63,5	33	88/3314	58/3314	
75	130	41,3	32	88/3215	58/3215	
	160	68,3	33	88/3315	58/3315	

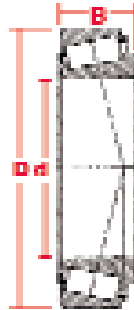

Roulements à une rangée de rouleaux coniques



d	D	B	Série		
17	40	13,25	302	88/30203	58/30203
	47	15,25	303	88/30303	58/30303
	47	20,25	323		58/32303
20	42	15	320		58/32004
	47	15,25	302	88/30204	58/30204
	52	16,25	303	88/30304	58/30304
	52	22,25	323	88/32304	58/32304
25	47	15	320	88/32005	58/32005
	52	16,25	302	88/30205	58/30205
	52	19,25	322		58/32205
	62	18,25	303	88/30305	58/30305
	62	18,25	313	88/31305	58/31305
30	62	25,25	323	88/32305	58/32305
	55	17	320	88/32006	58/32006
	62	17,25	302	88/30206	58/30206
	62	21,25	322	88/32206	58/32206
	72	20,75	303	88/30306	58/30306
	72	20,75	313	88/31306	58/31306
35	72	28,75	323	88/32306	58/32306
	62	18	320	88/32007	58/32007
	72	18,25	302	88/30207	58/30207
	72	24,25	322	88/32207	58/32207
	80	22,75	303	88/30307	58/30307
	80	22,75	313	88/31307	58/31307
40	80	32,75	323	88/32307	58/32307
	68	19	320	88/32008	58/32008
	80	19,75	302	88/30208	58/30208
	80	24,75	322	88/32208	58/32208
	90	25,25	303	88/30308	58/30308
	90	25,25	313	88/31308	58/31308
	90	35,25	323	88/32308	58/32308



Roulements à une rangée de rouleaux coniques

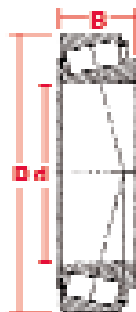

d	D	B	Série	bepco tractor parts	SKF
45	75	20	320	88/32009	58/32009
	85	20,75	302	88/30209	58/30209
	85	24,75	322	88/32209	58/32209
	100	27,25	303	88/30309	58/30309
	100	27,25	313	88/31309	58/31309
	100	38,25	323	88/32309	58/32309
50	80	20	320	88/32010	58/32010
	80	24	330		58/33010
	90	21,75	302	88/30210	58/30210
	90	24,75	322	88/32210	58/32210
	110	29,25	303	88/30310	58/30310
	110	29,25	313	88/31310	58/31310
55	110	42,25	323	88/32310	58/32310
	90	23	320	88/32011	58/32011
	90	27	330		58/33011
	100	22,75	302	88/30211	58/30211
	100	26,75	322	88/32211	58/32211
	120	31,5	303	88/30311	58/30311
60	120	31,5	313	88/31311	58/31311
	120	45,5	323	88/32311	58/32311
	95	23	320	88/32012	58/32012
	95	27	330		58/33012
	110	23,75	302	88/30212	58/30212
	110	29,75	322	88/32212	58/32212
65	130	33,5	303	88/30312	58/30312
	130	33,5	313	88/31312	58/31312
	130	48,5	323	88/32312	58/32312
	100	23	320	88/32013	58/32013
	100	27	330	88/33013	58/33013
	120	24,75	302	88/30213	58/30213
65	120	32,75	322	88/32213	58/32213
	140	36	303	88/30313	58/30313
	140	36	313	88/31313	58/31313
	140	51	323	88/32313	58/32313

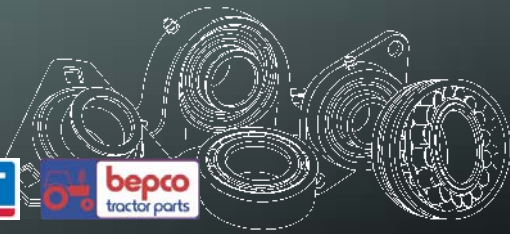

Roulements à une rangée de rouleaux coniques

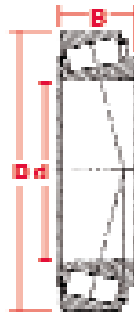

d	D	B	Série	bepco tractor parts	SKF
70	110	25	320	88/32014	58/32014
	110	31	330	88/33014	58/33014
	125	26,25	302	88/30214	58/30214
	125	33,25	322	88/32214	58/32214
	150	38	303	88/30314	58/30314
	150	38	313	88/31314	
	150	54	323	88/32314	58/32314
75	115	25	320	88/32015	58/32015
	115	31	330	88/33015	58/33015
	130	27,25	302	88/30215	58/30215
	130	33,25	322	88/32215	58/32215
	160	40	303	88/30315	58/30315
	160	58	323	88/32315	58/32315
80	125	29	320	88/32016	58/32016
	125	36	330	88/33016	58/33016
	140	28,25	302	88/30216	58/30216
	140	35,25	322	88/32216	58/32216
	170	42,5	303	88/30316	58/30316
	170	61,5	323	88/32316	58/32316
85	130	29	320	88/32017	58/32017
	130	36	330	88/33017	58/33017
	150	30,5	302	88/30217	58/30217
	150	38,5	322	88/32217	58/32217
	180	44,5	303	88/30317	58/30317
	180	63,5	323		58/32317
90	140	32	320	88/32018	58/32018
	140	39	330	88/33018	58/33018
	160	32,5	302	88/30218	58/30218
	160	42,5	322	88/32218	58/32218
	190	46,5	303		58/30318
95	145	32	320	88/32019	58/32019
	145	39	330	88/33019	58/33019
	170	34,5	302	88/30219	58/30219
	170	45,5	322	88/32219	58/32219
	200	49,5	303		58/30319



Roulements à une rangée de rouleaux coniques

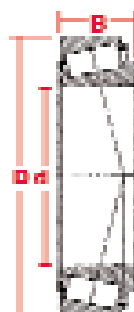

d	D	T	Série	bepco tractor parts	SKF
100	150	32	320	88/32020	58/32020
	150	39	330	88/33020	58/33020
	180	37	302	88/30220	58/30220
	180	49	322	88/32220	58/32220
105	160	35	320	88/32021	58/32021
	160	43	330		58/33021
	190	39	302	88/30221	58/30221
	190	53	322	88/32221	58/32221
110	170	38	320	88/32022	58/32022
	170	47	330	88/33022	58/33022
	200	41	302	88/30222	58/30222
	200	56	322	88/32222	58/32222
120	180	38	320	88/32024	58/32024
	180	48	330		58/33024
	215	43,5	302	88/30224	58/30224

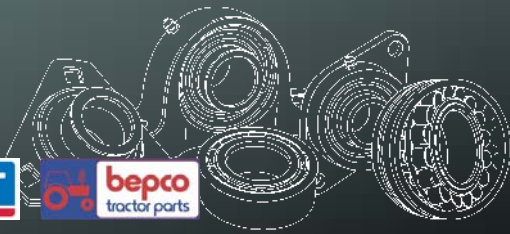

Roulements à une rangée de rouleaux cylindriques

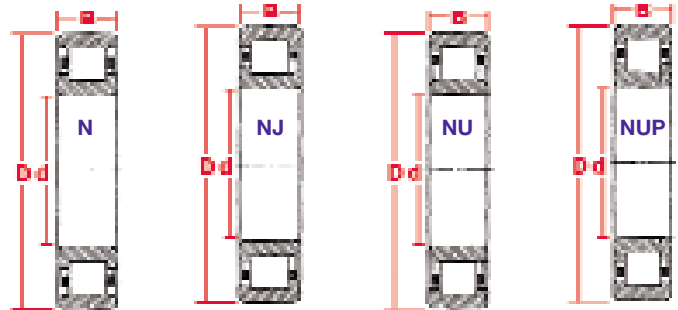

N : Bague extérieure sans épaulement et bague intérieure à 2 épaulements

NJ : Bague extérieure à 2 épaulements fixes et bague intérieure à 1 épaulement

NU : Bague extérieure à 2 épaulements fixes et bague intérieure sans épaulement

NUP : Bague extérieure à 2 épaulements fixes et bague intérieure à 1 épaulement fixe et 1 épaulement rapporté

d	D	B	Séries	bepco tractor parts				SKF				
				N	NJ	NU	NUP	N	NJ	NU	NUP	
15	35	11	200						58/NJ202	58/NU202		
	40	12	200					58/N203	58/NJ203	58/NU203	58/NUP203	
17	40	16	2200						58/NJ2203	58/NU2203	58/NUP2203	
	47	14	300					58/N303	58/NJ303	58/NU303		
20	47	14	200		88/NJ204	88/NU204	88/NUP204	58/N204	58/NJ204	58/NU204	58/NUP204	
	47	18	2200						58/NJ2204	58/NU2204		
	52	15	300				88/NUP304		58/NJ304	58/NU304	58/NUP304	
	52	21	2300						58/NJ2304	58/NU2304	58/NUP2304	
25	52	15	200		88/NJ205	88/NU205	88/NUP205	58/N205	58/NJ205	58/NU205	58/NUP205	
	52	18	2200		88/NJ2205	88/NU2205	88/NUP2205		58/NJ2205	58/NU2205	58/NUP2205	
	62	17	300		88/NJ305	88/NU305	88/NUP305	58/N305	58/NJ305	58/NU305	58/NUP305	
	62	24	2300		88/NJ2305	88/NU2305	88/NUP2305		58/NJ2305	58/NU2305	58/NUP2305	
30	62	16	200	88/N206	88/NJ206	88/NU206	88/NUP206	58/N206	58/NJ206	58/NU206	58/NUP206	
	62	20	2200		88/NJ2206	88/NU2206	88/NUP2206		58/NJ2206	58/NU2206	58/NUP2206	
	72	19	300		88/NJ306	88/NU306	88/NUP306	58/N306	58/NJ306	58/NU306	58/NUP306	
	72	27	2300		88/NJ2306	88/NU2306	88/NUP2306		58/NJ2306	58/NU2306	58/NUP2306	
35	72	17	200	88/N207	88/NJ207	88/NU207	88/NUP207	58/N207	58/NJ207	58/NU207	58/NUP207	
	72	23	2200		88/NJ2207	88/NU2207	88/NUP2207		58/NJ2207	58/NU2207	58/NUP2207	
	80	21	300	88/N307	88/NJ307	88/NU307	88/NUP307	58/N307	58/NJ307	58/NU307	58/NUP307	
	80	31	2300		88/NJ2307	88/NU2307	88/NUP2307		58/NJ2307	58/NU2307	58/NUP2307	
40	80	18	200	88/N208	88/NJ208	88/NU208	88/NUP208	58/N208	58/NJ208	58/NU208	58/NUP208	
	80	23	2200		88/NJ2208	88/NU2208	88/NUP2208		58/NJ2208	58/NU2208	58/NUP2208	
	90	23	300	88/N308	88/NJ308	88/NU308	88/NUP308	58/N308	58/NJ308	58/NU308	58/NUP308	
	90	33	2300		88/NJ2308	88/NU2308	88/NUP2308		58/NJ2308	58/NU2308	58/NUP2308	
45	85	19	200	88/N209	88/NJ209	88/NU209	88/NUP209	58/N209	58/NJ209	58/NU209	58/NUP209	
	85	23	2200		88/NJ2209	88/NU2209	88/NUP2209		58/NJ2209	58/NU2209	58/NUP2209	
	100	25	300	88/N309	88/NJ309	88/NU309	88/NUP309	58/N309	58/NJ309	58/NU309	58/NUP309	
	100	36	2300		88/NJ2309	88/NU2309	88/NUP2309		58/NJ2309	58/NU2309	58/NUP2309	
50	90	20	200	88/N210	88/NJ210	88/NU210	88/NUP210	58/N210	58/NJ210	58/NU210	58/NUP210	
	90	23	2200		88/NJ2210	88/NU2210	88/NUP2210		58/NJ2210	58/NU2210	58/NUP2210	
	110	27	300	88/N310	88/NJ310	88/NU310	88/NUP310	58/N310	58/NJ310	58/NU310	58/NUP310	
	110	40	2300		88/NJ2310	88/NU2310	88/NUP2310		58/NJ2310	58/NU2310	58/NUP2310	

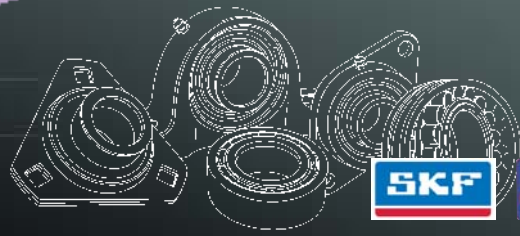

Roulements à une rangée de rouleaux cylindriques

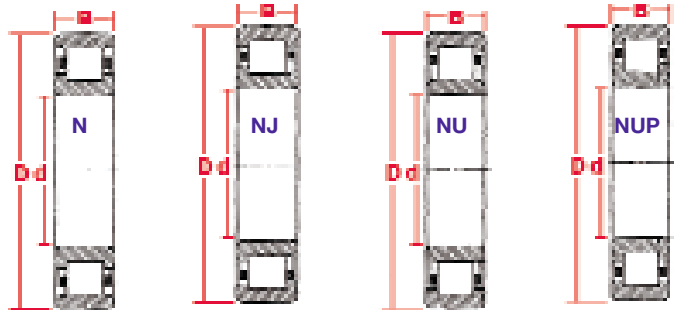

N : Bague extérieure sans épaulement et bague intérieure à 2 épaulements

NJ : Bague extérieure à 2 épaulements fixes et bague intérieure à 1 épaulement

NU : Bague extérieure à 2 épaulements fixes et bague intérieure sans épaulement

NUP : Bague extérieure à 2 épaulements fixes et bague intérieure à 1 épaulement fixe et 1 épaulement rapporté

d	D	B	Séries	bepco tractor parts				SKF			
				N	NJ	NU	NUP	N	NJ	NU	NUP
55	100	21	200	88/N211	88/NJ211	88/NU211	88/NUP211	58/N211	58/NJ211	58/NU211	58/NUP211
	100	25	2200		88/NJ2211	88/NU2211	88/NUP2211		58/NJ2211	58/NU2211	58/NUP2211
	120	29	300	88/N311	88/NJ311	88/NU311	88/NUP311	58/N311	58/NJ311	58/NU311	58/NUP311
	120	43	2300		88/NJ2311	88/NU2311	88/NUP2311		58/NJ2311	58/NU2311	58/NUP2311
60	110	22	200	88/N212	88/NJ212	88/NU212	88/NUP212	58/N212	58/NJ212	58/NU212	58/NUP212
	110	28	2200		88/NJ2212	88/NU2212	88/NUP2212		58/NJ2212	58/NU2212	58/NUP2212
	130	31	300	88/N312	88/NJ312	88/NU312	88/NUP312	58/N312	58/NJ312	58/NU312	58/NUP312
	130	46	2300		88/NJ2312	88/NU2312	88/NUP2312		58/NJ2312	58/NU2312	58/NUP2312
65	120	23	200		88/NJ213	88/NU213	88/NUP213	58/N213	58/NJ213	58/NU213	58/NUP213
	120	31	2200		88/NJ2213	88/NU2213	88/NUP2213		58/NJ2213	58/NU2213	58/NUP2213
	140	33	300	88/N313	88/NJ313	88/NU313	88/NUP313	58/N313	58/NJ313	58/NU313	58/NUP313
	140	48	2300		88/NJ2313	88/NU2313	88/NUP2313		58/NJ2313	58/NU2313	58/NUP2313
70	125	24	200		88/NJ214	88/NU214	88/NUP214	58/N214	58/NJ214	58/NU214	58/NUP214
	125	31	2200		88/NJ2214	88/NU2214	88/NUP2214		58/NJ2214	58/NU2214	58/NUP2214
	150	35	300	88/N314	88/NJ314	88/NU314	88/NUP314	58/N314	58/NJ314	58/NU314	58/NUP314
	150	51	2300		88/NJ2314	88/NU2314	88/NUP2314		58/NJ2314	58/NU2314	58/NUP2314
75	130	25	200			88/NU215	88/NUP215	58/N215	58/NJ215	58/NU215	58/NUP215
	130	31	2200		88/NJ2215	88/NU2215	88/NUP2215		58/NJ2215	58/NU2215	58/NUP2215
	160	37	300		88/NJ315	88/NU315	88/NUP315	58/N315	58/NJ315	58/NU315	58/NUP315
	160	55	2300		88/NJ2315	88/NU2315	88/NUP2315		58/NJ2315	58/NU2315	58/NUP2315
80	140	26	200					58/N216	58/NJ216	58/NU216	58/NUP216
	140	33	2200						58/NJ2216	58/NU2216	58/NUP2216
	170	39	300			88/NU316	88/NUP316	58/N316	58/NJ316	58/NU316	58/NUP316
	170	58	2300						58/NJ2316	58/NU2316	
85	150	36	2200						58/NJ2217	58/NU2217	58/NUP2217
	180	41	300			88/NU317	88/NUP317	58/N317	58/NJ317	58/NU317	58/NUP317
90	160	40	2200						58/NJ2218	58/NU2218	58/NUP2218
100	180	46	2200						58/NJ2220	58/NU2220	58/NUP2220

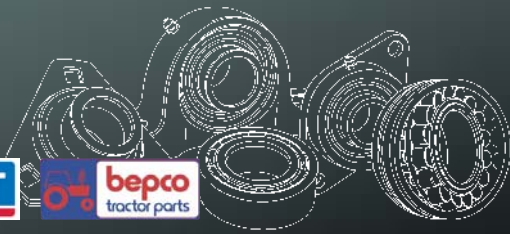

Roulements à rotule à deux rangées de rouleaux sphérique



Pas de suffixe : Ouvert
K : Conique

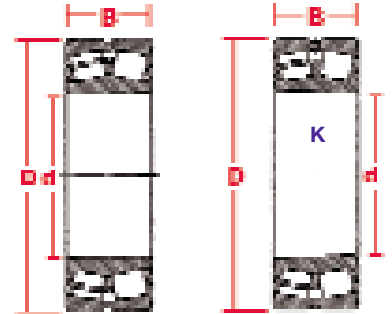

d	D	B	Série	bepco tractor parts		SKF	
				Normal	K	Normal	K
25	52	18	222	88/22205		58/22205	58/22205K
	62	17	213	88/21305		58/21305	
30	62	20	222	88/22206		58/22206	58/22206K
	72	19	213	88/21306		58/21306	
35	72	23	222	88/22207	88/22207K	58/22207	58/22207K
	80	21	213	88/21307		58/21307	58/21307K
40	80	23	222	88/22208	88/22208K	58/22208	58/22208K
	90	23	213	88/21308	88/21308K	58/21308	58/21308K
	90	33	223	88/22308	88/22308K	58/22308	58/22308K
45	85	23	222	88/22209	88/22209K	58/22209	58/22209K
	100	25	213	88/21309	88/21309K	58/21309	58/21309K
	100	36	223	88/22309	88/22309K	58/22309	58/22309K
50	90	23	222	88/22210	88/22210K	58/22210	58/22210K
	110	27	213	88/21310	88/21310K	58/21310	58/21310K
	110	40	223	88/22310	88/22310K	58/22310	58/22310K
55	100	25	222	88/22211	88/22211K	58/22211	58/22211K
	120	29	213	88/21311	88/21311K	58/21311	58/21311K
	120	43	223	88/22311	88/22311K	58/22311	58/22311K
60	110	28	222	88/22212	88/22212K	58/22212	58/22212K
	130	31	213	88/21312	88/21312K	58/21312	58/21312K
	130	46	223	88/22312	88/22312K	58/22312	58/22312K
65	120	31	222	88/22213	88/22213K	58/22213	58/22213K
	140	33	213	88/21313	88/21313K	58/21313	58/21313K
	140	48	223	88/22313	88/22313K	58/22313	58/22313K
70	125	31	222	88/22214	88/22214K	58/22214	58/22214K
	150	35	213	88/21314		58/21314	58/21314K
	150	51	223	88/22314	88/22314K	58/22314	58/22314K
75	130	31	222	88/22215	88/22215K	58/22215	58/22215K
	160	37	213	88/21315	88/21315K	58/21315	58/21315K
	160	55	223	88/22315	88/22315K	58/22315	58/22315K

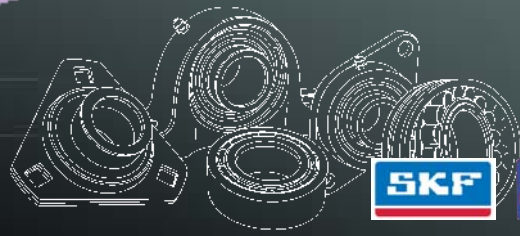

Roulements à rotule à deux rangées de rouleaux sphériques



Pas de suffixe : Ouvert
K : Conique

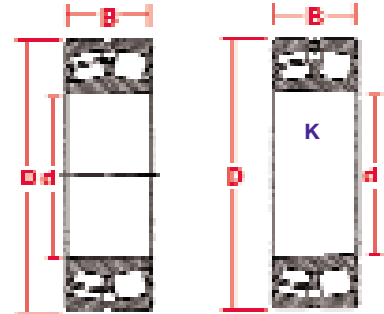

d	D	B	Série	bepco tractor parts		SKF	
				Normal	K	Normal	K
80	140	33	222	88/22216	88/22216K	58/22216	58/22216K
	170	39	213	88/21316	88/21316K	58/21316	58/21316K
	170	58	223	88/22316	88/22316K	58/22316	58/22316K
85	150	36	222	88/22217	88/22217K	58/22217	58/22217K
	180	41	213	88/21317	88/21317K	58/21317	58/21317K
90	160	40	222	88/22218	88/22218K	58/22218	58/22218K
	190	43	213	88/21318	88/21318K	58/21318	58/21318K
95	170	43	222	88/22219	88/22219K	58/22219	58/22219K
	200	45	213			58/21319	58/21319K
100	180	46	222	88/22220	88/22220K	58/22220	58/22220K
	215	47	213			58/21320	58/21320K

Roulements

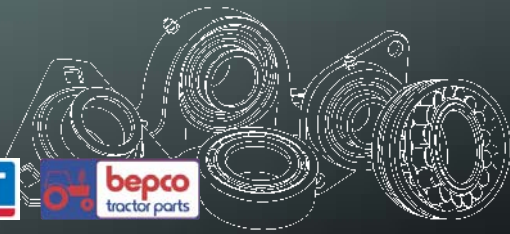

Roulements à une rangée d'aiguilles

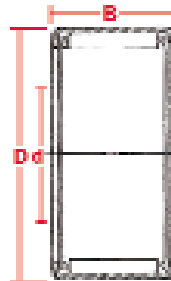

d	D	B	SKF
8	12	10	58/HK0810
10	14	10	58/HK1010
12	18	12	58/HK1212
15	21	12	58/HK1512
		16	58/HK1516
		22	58/HK1522
16	22	16	58/HK1616
18	24	12	58/HK1812
		16	58/HK1816
20	26	12	58/HK2012
		16	58/HK2016
		20	58/HK2020
		30	58/HK2030
22	28	12	58/HK2212
		16	58/HK2216
		20	58/HK2220
25	32	12	58/HK2512
		16	58/HK2516
		20	58/HK2520
		26	58/HK2526
28	35	38	58/HK2538
		20	58/HK2820
		12	58/HK3012
30	37	16	58/HK3016
		20	58/HK3020
		26	58/HK3026
		38	58/HK3038
35	42	12	58/HK3512
		16	58/HK3516
		20	58/HK3520
40	47	12	58/HK4012
		16	58/HK4016
		20	58/HK4020
45	52	16	58/HK4516
		20	58/HK4520
50	58	20	58/HK5020
		25	58/HK5025



Ecrous de serrage et rondelles de frein

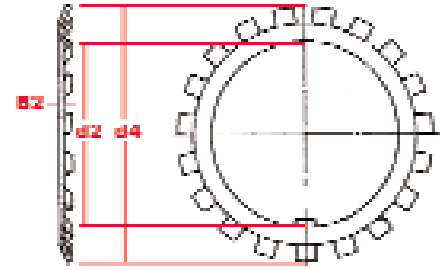
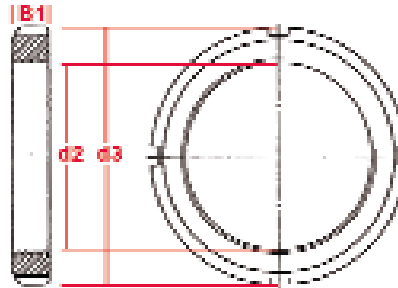

d2	d3	B1	Filet	Ecrou de serrage		d2	d4	B2	Rondelle de frein	
				bepco tractor parts	SKF				bepco tractor parts	SKF
10	18	4	M10x0.75	88/KM0	58/KM0	10	21	1	88/MB0	58/MB0
12	22	4	M12x1	88/KM1	58/KM1	12	25	1	88/MB1	58/MB1
15	25	5	M15x1	88/KM2	58/KM2	15	28	1	88/MB2	58/MB2
17	28	5	M17x1	88/KM3	58/KM3	17	32	1	88/MB3	58/MB3
20	32	6	M20x1	88/KM4	58/KM4	20	36	1	88/MB4	58/MB4
25	38	7	M25x1.5	88/KM5	58/KM5	25	42	1,25	88/MB5	58/MB5
30	45	7	M30x1.5	88/KM6	58/KM6	30	49	1,25	88/MB6	58/MB6
35	52	8	M35x1.5	88/KM7	58/KM7	35	57	1,25	88/MB7	58/MB7
40	58	9	M40x1.5	88/KM8	58/KM8	40	62	1,25	88/MB8	58/MB8
45	65	10	M45x1.5	88/KM9	58/KM9	45	69	1,25	88/MB9	58/MB9
50	70	11	M50x1.5	88/KM10	58/KM10	50	74	1,25	88/MB10	58/MB10
55	75	11	M55x2	88/KM11	58/KM11	55	81	1,5	88/MB11	58/MB11
60	80	11	M60x2	88/KM12	58/KM12	60	86	1,5	88/MB12	58/MB12
65	85	12	M65x2	88/KM13	58/KM13	65	92	1,5	88/MB13	58/MB13
70	92	12	M70x2	88/KM14	58/KM14	70	98	1,5	88/MB14	58/MB14
75	98	13	M75x2	88/KM15	58/KM15	75	104	1,5	88/MB15	58/MB15
80	105	15	M80x2	88/KM16	58/KM16	80	112	1,75	88/MB16	58/MB16
85	110	16	M85x2	88/KM17	58/KM17	85	119	1,75	88/MB17	58/MB17
90	120	16	M90x2	88/KM18	58/KM18	90	126	1,75	88/MB18	58/MB18
95	125	17	M95x2	88/KM19	58/KM19	95	133	1,75	88/MB19	58/MB19
100	130	18	M100x2	88/KM20	58/KM20	100	142	1,75	88/MB20	58/MB20
105	140	18	M105x2	88/KM21	58/KM21	105	145	1,75	88/MB21	58/MB21
110	145	19	M110x2	88/KM22	58/KM22	110	154	1,75	88/MB22	58/MB22
115	150	19	M115x2	88/KM23	58/KM23	115	159	2	88/MB23	58/MB23
120	155	20	M120x2	88/KM24	58/KM24	120	164	2	88/MB24	58/MB24

Roulements

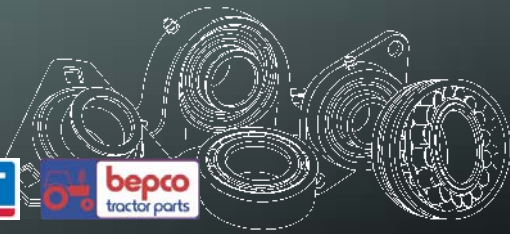

Manchons de serrage

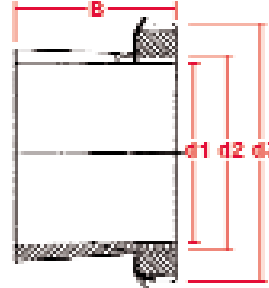

d1	d2	d3	B	Filet	Série	Manchon de serrage		Roulement correspondant	Ecrus correspondant	Rondelle de frein correspondante
25	30	45	27	M30x1.5	H2	88/H206	58/H206	1206K	KM6	MB6
			38		H23	88/H2306	58/H2306	2306K,		
			31		H3	88/H306	58/H306	1306K, 2206K, 21306K, 22206K		
30	35	52	29	M35x1.5	H2	88/H207	58/H207	1207K	KM7	MB7
			43		H23	88/H2307	58/H2307	2307K		
			35		H3	88/H307	58/H307	1307K, 2207K, 21307K, 22207K		
35	40	58	31	M40x1.5	H2	88/H208	58/H208	1208K	KM8	MB8
			46		H23	88/H2308	58/H2308	2308K		
			36		H3	88/H308	58/H308	1308K, 2208K, 21308K, 22208K		
40	45	65	33	M45x1.5	H2	88/H209	58/H209	1209K	KM9	MB9
			50		H23	88/H2309	58/H2309	2309K, 22309K		
			39		H3	88/H309	58/H309	1309K, 2209K, 21309K, 22209K		
45	50	70	35	M50x1.5	H2	88/H210	58/H210	1210K	KM10	MB10
			55		H23	88/H2310	58/H2310	2310K, 22310K		
			42		H3	88/H310	58/H310	1310K, 2210K, 21310K, 22210K		
50	55	75	37	M55x2	H2	88/H211	58/H211	1211K	KM11	MB11
			59		H23	88/H2311	58/H2311	2311K, 22311K		
			45		H3	88/H311	58/H311	1311K, 2211K, 21311K, 22211K		
55	60	80	38	M60x2	H2	88/H212	58/H212	1212K	KM12	MB12
			62		H23	88/H2312	58/H2312	2312K, 22312K		
			47		H3	88/H312	58/H312	1312K, 2212K, 21312K, 22212K		
60	65	85	40	M65x2	H2	88/H213	58/H213	1213K	KM13	MB13
			65		H23	88/H2313	58/H2313	2313K, 22313K		
			50		H3	88/H313	58/H313	1313K, 2213K, 21313K, 22213K		
65	70	92	68	M70x2	H23	88/H2314	58/H2314	22314K	KM14	MB14
			52		H3	88/H314	58/H314	21314K, 22214K		
			43		H2	88/H215	58/H215	1215K		
65	75	98	73	M75x2	H23	88/H2315	58/H2315	22315K	KM15	MB15
			55		H3	88/H315	58/H315	2215K, 21315K, 22215K		
			46		H2	88/H216	58/H216	1216K		
70	80	105	78	M80x2	H23	88/H2316	58/H2316	22316K	KM16	MB16
			59		H3	88/H316	58/H316	2216K, 21316K, 22216K		



Manchons de serrage

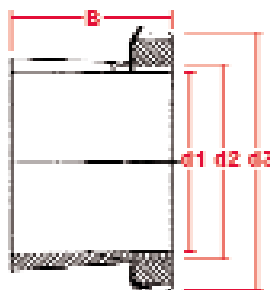

d1	d2	d3	B	Filet	Série	Manchon de serrage		Roulement correspondant	Erou correspondant	Rondelle de frein correspondante
75	85	110	50	M85x2	H2	88/H217	58/H217	1217K	KM17	MB17
			82	M85x2	H23	88/H2317	58/H2317			
			63	M85x2	H3	88/H317	58/H317	2217K, 21317K, 22217K		
80	90	120	52	M90x2	H2	88/H218	58/H218	1218K	KM18	MB18
			86	M90x2	H23	88/H2318	58/H2318			
			65	M90x2	H3	88/H318	58/H318	2218K, 21318K, 22218K		
85	95	125	55	M95x2	H2	88/H219	58/H219		KM19	MB19
			90	M95x2	H23	88/H2319	58/H2319			
			68	M95x2	H3	88/H319	58/H319	219K, 21319K, 22219K		
90	100	130	58	M100x2	H2	88/H220	58/H220		KM20	MB20
			97	M100x2	H23	88/H2320	58/H2320			
			71	M100x2	H3	88/H320	58/H320	2220K, 21320K, 22220K		

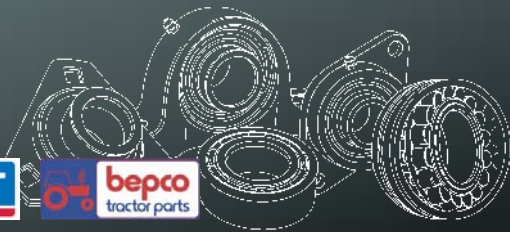

Paliers autoaligneurs en fonte série UCF/FY

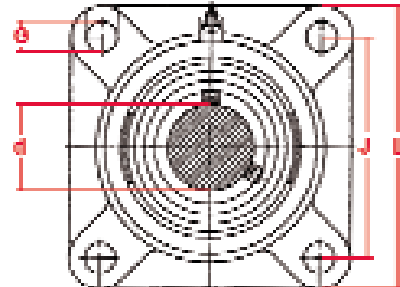

d	J	L	G	bepco tractor parts			SKF		
				Palier compl.	Corps	Roulement	Palier compl.	Corps	Roulement
20	63,5	86	M10	88/UCF204	88/F204	88/UC204	58/FY20TF	58/FY504M	58/YAR204-2F
25	70	95	M10	88/UCF205	88/F205	88/UC205	58/FY25TF	58/FY505M	58/YAR205-2F
30	82,5	108	M10	88/UCF206	88/F206	88/UC206	58/FY30TF	58/FY506M	58/YAR206-2F
35	92	118	M12	88/UCF207	88/F207	88/UC207	58/FY35TF	58/FY507M	58/YAR207-2F
40	101,5	130	M12	88/UCF208	88/F208	88/UC208	58/FY40TF	58/FY508M	58/YAR208-2F
45	105	137	M14	88/UCF209	88/F209	88/UC209	58/FY45TF	58/FY509M	58/YAR209-2F
50	111	143	M16	88/UCF210	88/F210	88/UC210	58/FY50TF	58/FY510M	58/YAR210-2F
55	130	162	M16	88/UCF211	88/F211	88/UC211	58/FY55TF	58/FY511M	58/YAR211-2F
60	143	175	M16	88/UCF212	88/F212	88/UC212	58/FY60TF	58/FY512M	58/YAR212-2F
65	149,5	187	M16	88/UCF213	88/F213	88/UC213	58/FY65TF	58/FY513M	58/YAR213-2F
70	152	193	M16	88/UCF214	88/F214	88/UC214	58/FYJ70TF	58/FYJ514	58/YAR214-2F
80	165	208	M20	88/UCF216	88/F216	88/UC216	58/FYJ80TF	58/FYJ516	58/YAR216-2F

Les paliers repris ci-dessus sont montés avec un roulement UC/YAR : vis de blocage et bague intérieure débordant des deux côté.
 Ils sont disponibles aussi avec roulements SA/YET avec bague de blocage excentrique et bague intérieure débordantes des deux côtés
 ou avec roulement NA/YEL avec bague de blocage excentrique et bague intérieure débordantes des deux côtés.
 Commander le corps et roulement séparément dans les sections correspondantes ou consultez-nous.



Paliers autoaligneurs en fonte série UCFL/FYTB

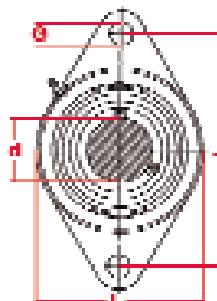

d	J	L	G	bepco tractor parts			SKF		
				Palier compl.	Corps	Roulement	Palier compl.	Corps	Roulement
20	90	60,5	M10	88/UCFL204	88/FL204	88/UC204	58/FYTB20TF	58/FYTB504M	58/YAR204-2F
25	99	70	M10	88/UCFL205	88/FL205	88/UC205	58/FYTB25TF	58/FYTB505M	58/YAR205-2F
30	116,5	83	M10	88/UCFL206	88/FL206	88/UC206	58/FYTB30TF	58/FYTB506M	58/YAR206-2F
35	130	96	M12	88/UCFL207	88/FL207	88/UC207	58/FYTB35TF	58/FYTB507M	58/YAR207-2F
40	143,5	102	M12	88/UCFL208	88/FL208	88/UC208	58/FYTB40TF	58/FYTB508M	58/YAR208-2F
45	148,5	111	M16 M14*	88/UCFL209	88/FL209	88/UC209	58/FYTB45TF*	58/FYTB509M*	58/YAR209-2F
50	157	116	M16	88/UCFL210	88/FL210	88/UC210	58/FYTB50TF	58/FYTB510M	58/YAR210-2F

Les paliers repris ci-dessus sont montés avec un roulement UC/YAR : vis de blocage et bague intérieure débordant des deux côté. Ils sont disponibles aussi avec roulements SA/YET avec bague de blocage excentrique et bague intérieure débordantes des deux côtés ou avec roulement NA/YEL avec bague de blocage excentrique et bague intérieure débordantes des deux côtés. Commander le corps et roulement séparément dans les sections correspondantes ou consultez-nous.

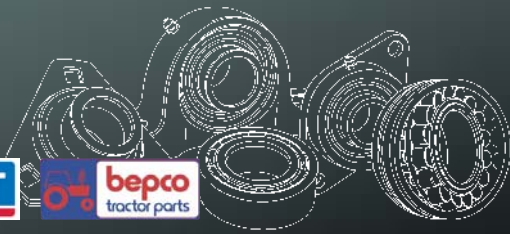

Paliers autoaligneurs en fonte série UCP/SY

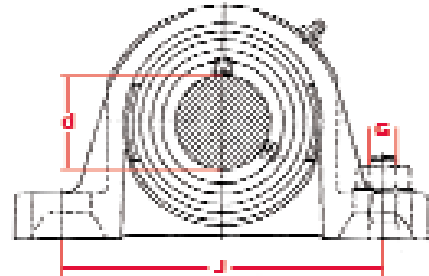

d	J	G						
			Palier compl.	Corps	Roulement	Palier compl.	Corps	Roulement
20	96	M10	88/UCP204	88/P204	88/UC204	58/SY20TF	58/SY504M	58/YAR204-2F
25	105	M10	88/UCP205	88/P205	88/UC205	58/SY25TF	58/SY505M	58/YAR205-2F
30	121	M12	88/UCP206	88/P206	88/UC206	58/SY30TF	58/SY506M	58/YAR206-2F
35	126	M12	88/UCP207	88/P207	88/UC207	58/SY35TF	58/SY507M	58/YAR207-2F
40	136	M12	88/UCP208	88/P208	88/UC208	58/SY40TF	58/SY508M	58/YAR208-2F
45	146	M12	88/UCP209	88/P209	88/UC209	58/SY45TF	58/SY509M	58/YAR209-2F
50	159	M16	88/UCP210	88/P210	88/UC210	58/SY50TF	58/SY510M	58/YAR210-2F
55	172	M16	88/UCP211	88/P211	88/UC211	58/SY55TF	58/SY511M	58/YAR211-2F
60	186	M16	88/UCP212	88/P212	88/UC212	58/SY60TF	58/SY512M	58/YAR212-2F
65	203	M20	88/UCP213	88/P213	88/UC213	58/SY65TF	58/SY513M	58/YAR213-2F
70	210	M20	88/UCP214	88/P214	88/UC214	58/SYJ70TF	58/SYJ514	58/YAR214-2F

Les paliers repris ci-dessus sont montés avec un roulement UC/YAR : vis de blocage et bague intérieure débordant des deux côté.
 Ils sont disponibles aussi avec roulements SA/YET avec bague de blocage excentrique et bague intérieure débordantes des deux côtés
 ou avec roulement NA/YEL avec bague de blocage excentrique et bague intérieure débordantes des deux côtés.
 Commander le corps et roulement séparément dans les sections correspondantes ou consultez-nous.



Paliers autoaligneurs en tôle série PP/P

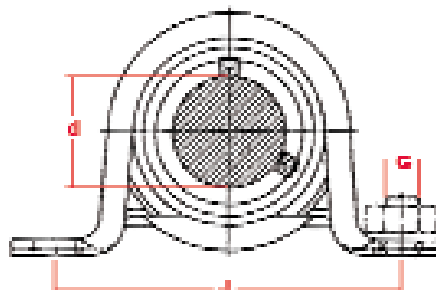

d	J	G	bepco tractor parts			SKF		
			Palier compl.	Corps	Roulement	Palier compl.	Corps	Roulement
15	68	M8	88/SAPP202	88/PP202		58/P15FM	58/P40	58/YET203/15
17	68	M8	88/SAPP203	88/PP203		58/P17FM	58/P40	58/YET203
20	76	M8	88/SAPP204	88/PP204	88/SA204	58/P20FM	58/P47	58/YET204
25	86	M10	88/SAPP205	88/PP205	88/SA205	58/P25FM	58/P52	58/YET205
30	95	M10	88/SAPP206	88/PP206	88/SA206	58/P30FM	58/P62	58/YET206
35	106	M10	88/SAPP207	88/PP207	88/SA207	58/P35FM	58/P72	58/YET207
40	120	M12				58/P40FM	58/P80	58/YET208
45	128	M12				58/P45FM	58/P85	58/YET209

Les paliers repris ci-dessus sont montés avec un roulement SA/YET avec bague de blocage excentrique et bague intérieure débordantes des deux côtés.

Ils sont disponibles aussi avec roulements UC/YAR : vis de blocage et bague intérieure débordant des deux côté ou avec roulement NA/YEL avec bague de blocage excentrique et bague intérieure débordantes des deux côtés. Commander le corps et roulement séparément dans les sections correspondantes ou consultez-nous.

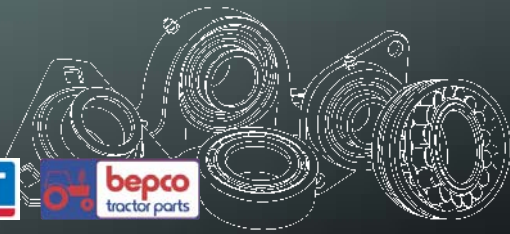

Paliers autoaligneurs en tôle série PFL/PFT

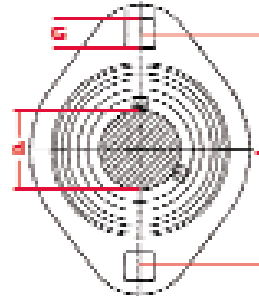
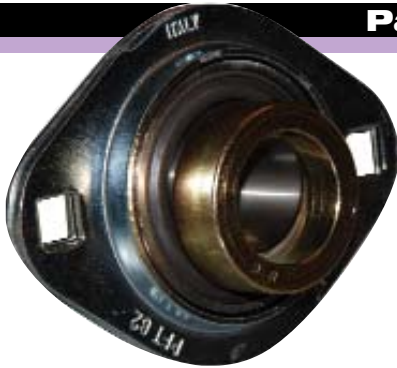

d	J	G	bepco tractor parts			SKF		
			Palier compl.	Corps	Roulement	Palier compl.	Corps	Roulement
15	63	M6	88/SAPFL202	88/PFL202		58/PFT15FM	58/PFT40	58/YET203/15
17	63	M6	88/SAPFL203	88/PFL203		58/PFT17FM	58/PFT40	58/YET203
20	71,5	M8	88/SAPFL204	88/PFL204	88/SA204	58/PFT20FM	58/PFT47	58/YET204
25	76	M8	88/SAPFL205	88/PFL205	88/SA205	58/PFT25FM	58/PFT52	58/YET205
30	90,5	M10	88/SAPFL206	88/PFL206	88/SA206	58/PFT30FM	58/PFT62	58/YET206
35	100	M10	88/SAPFL207	88/PFL207	88/SA207	58/PFT35FM	58/PFT72	58/YET207
40	119	M12				58/PFT40FM	58/PFT80	58/YET208

Les paliers repris ci-dessus sont montés avec un roulement SA/YET avec bague de blocage excentrique et bague intérieure débordantes des deux côtés.

Ils sont disponibles aussi avec roulements UC/YAR : vis de blocage et bague intérieure débordant des deux côté ou avec roulement NA/YEL avec bague de blocage excentrique et bague intérieure débordantes des deux côtés. Commander le corps et roulement séparément dans les sections correspondantes ou consultez-nous.



Paliers autoaligneurs en tôle série PFT/PFD

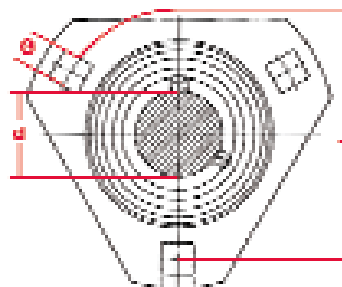

d	J	G	bepco tractor parts			SKF		
			Palier compl.	Corps	Roulement	Palier compl.	Corps	Roulement
15	63	M6	88/SAPFT202	88/PFT202		58/PFD15FM	58/PFD40	58/YET203/15
17	63	M6	88/SAPFT203	88/PFT203		58/PFD17FM	58/PFD40	58/YET203
20	71,5	M8	88/SAPFT204	88/PFT204	88/SA204	58/PFD20FM	58/PFD47	58/YET204
25	76	M8	88/SAPFT205	88/PFT205	88/SA205	58/PFD25FM	58/PFD52	58/YET205
30	90,5	M10	88/SAPFT206	88/PFT206	88/SA206	58/PFD30FM	58/PFD62	58/YET206
35	100	M10	88/SAPFT207	88/PFT207	88/SA207	58/PFD35FM	58/PFD72	58/YET207
40	119	M12	88/SAPFT208	88/PFT208	88/SA208			

Les paliers repris ci-dessus sont montés avec un roulement SA/YET avec bague de blocage excentrique et bague intérieure débordantes des deux côtés.

Ils sont disponibles aussi avec roulements UC/YAR : vis de blocage et bague intérieure débordant des deux côté ou avec roulement NA/YEL avec bague de blocage excentrique et bague intérieure débordantes des deux côtés. Commander le corps et roulement séparément dans les sections correspondantes ou consultez-nous.

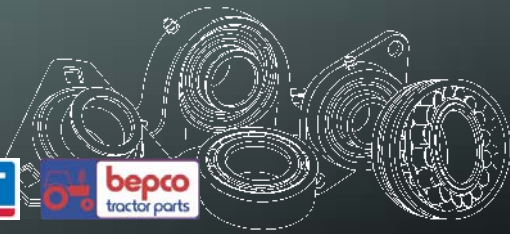

Paliers autoaligneurs en tôle série PF/PF

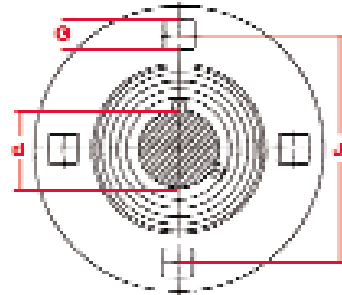

d	J	G	bepco tractor parts			SKF		
			Palier compl.	Corps	Roulement	Palier compl.	Corps	Roulement
15	63	M6	88/SAPF202	88/PF202		58/PF15FM	58/PF40	58/YET203/15
17	63	M6	88/SAPF203	88/PF203		58/PF17FM	58/PF40	58/YET203
20	71,5	M8	88/SAPF204	88/PF204	88/SA204	58/PF20FM	58/PF47	58/YET204
25	76	M8	88/SAPF205	88/PF205	88/SA205	58/PF25FM	58/PF52	58/YET205
30	90,5	M10	88/SAPF206	88/PF206	88/SA206	58/PF30FM	58/PF62	58/YET206
35	100	M10	88/SAPF207	88/PF207	88/SA207	58/PF35FM	58/PF72	58/YET207
40	119	M12	88/SAPF208	88/PF208	88/SA208	58/PF40FM	58/PF80	58/YET208
45	121	M12				58/PF45FM	58/PF85	58/YET209
50	127	M12				58/PF50FM	58/PF90	58/YET210

Les paliers repris ci-dessus sont montés avec un roulement SA/YET avec bague de blocage excentrique et bague intérieure débordantes des deux côtés.

Ils sont disponibles aussi avec roulements UC/YAR : vis de blocage et bague intérieure débordant des deux côté ou avec roulement NA/YEL avec bague de blocage excentrique et bague intérieure débordantes des deux côtés. Commander le corps et roulement séparément dans les sections correspondantes ou consultez-nous.

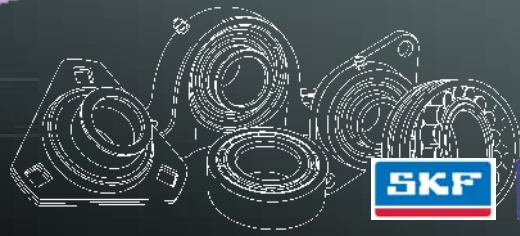

Roulements SA/YET/162 pour paliers autoaligneurs

d	D	bepco tractor parts		SKF	
		Roulement	C	Roulement	C
15	40		13	58/YET203/15	12
17	40		13	58/YET203	12
20	47	88/SA204	14	58/YET204	14
25	52	88/SA205	15	58/YET205	15
30	62	88/SA206	16	58/YET206	18
35	72	88/SA207	18	58/YET207	19
40	80	88/SA208	19	58/YET208	21
45	85	88/SA209	20	58/YET209	22
50	90		20	58/YET210	22

Avec bague de blocage excentrique et bague intérieure débordantes d'un côté

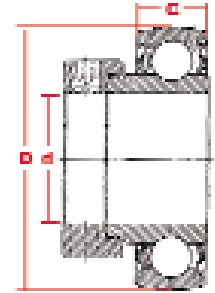

Roulements NA/YEL/251 pour paliers autoaligneurs

d	D	bepco tractor parts		SKF	
		Roulement	C	Roulement	C
20	47	88/NA204	16	58/YEL204	14
25	52	88/NA205	17	58/YEL205	15
30	62	88/NA206	19	58/YEL206	18
35	72	88/NA207	20	58/YEL207	19
40	80	88/NA208	21	58/YEL208	21
45	85	88/NA209	22	58/YEL209	22
50	90		23	58/YEL210	22

Avec bague de blocage excentrique et bague intérieure débordantes des deux côtés

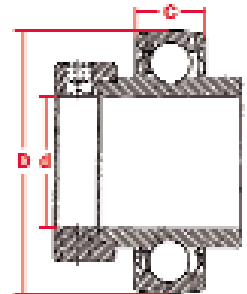

Roulements UC/YAR/562 pour paliers autoaligneurs

d	D	bepco tractor parts		SKF	
		Roulement	C	Roulement	C
15	40	88/UC202	14	58/YAR203/15-2F	12
17	40	88/UC203	14	58/YAR203-2F	12
20	47	88/UC204	16	58/YAR204-2F	14
25	52	88/UC205	17	58/YAR205-2F	15
30	62	88/UC206	19	58/YAR206-2F	18
35	72	88/UC207	20	58/YAR207-2F	19
40	80	88/UC208	21	58/YAR208-2F	21
45	85	88/UC209	22	58/YAR209-2F	22
50	90	88/UC210	23	58/YAR210-2F	22

Avec vis de blocage et bague intérieure débordant des deux côtés

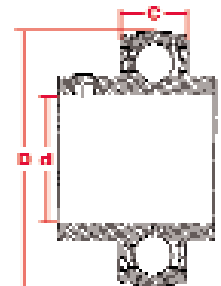

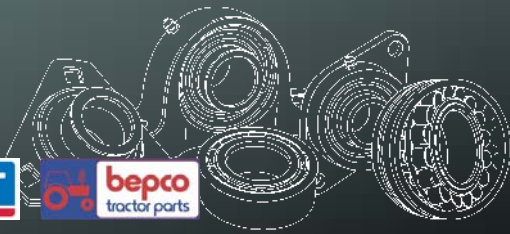

Rotules radiales

Pas de suffixe : Ouvert
2RS : Etanche

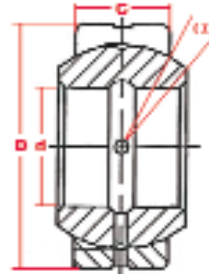

d	D	B	α	Série	bepco tractor parts		SKF	
					Ouvert	2RS	Ouvert	2RS
20	35	16	9	GE	88/GE20ES	88/GE20ES-2RS	58/GE20ES	58/GE20ES-2RS
	42	25	17	GEG/GEH				58/GEH20ES-2RS
25	42	20	7	GE	88/GE25ES	88/GE25ES-2RS	58/GE25ES	58/GE25ES-2RS
	47	28	17	GEG/GEH				58/GEH25ES-2RS
30	47	22	6	GE	88/GE30ES	88/GE30ES-2RS	58/GE30ES	58/GE30ES-2RS
	55	32	17	GEG/GEH				58/GEH30ES-2RS
35	55	25	6	GE	88/GE35ES	88/GE35ES-2RS	58/GE35ES	58/GE35ES-2RS
	62	35	16	GEG/GEH				58/GEH35ES-2RS
40	62	28	7	GE	88/GE40ES	88/GE40ES-2RS	58/GE40ES	58/GE40ES-2RS
	68	40	17	GEG/GEH				58/GEH40ES-2RS
45	68	32	7	GE	88/GE45ES	88/GE45ES-2RS	58/GE45ES	58/GE45ES-2RS
	75	43	15	GEG/GEH				58/GEH45ES-2RS
50	75	35	6	GE	88/GE50ES	88/GE50ES-2RS	58/GE50ES	58/GE50ES-2RS
	90	56	17	GEG/GEH				58/GEH50ES-2RS
60	90	44	6	GEG/GEH	88/GE60ES	88/GE60ES-2RS	58/GE60ES	58/GE60ES-2RS
	105	63	17	GEG				58/GEH60ES-2RS
70	105	49	6	GEG/GEH	88/GE70ES	88/GE70ES-2RS	58/GE70ES	58/GE70ES-2RS
	120	70	16	GEG				58/GEH70ES-2RS
80	120	55	6	GEG/GEH	88/GE80ES	88/GE80ES-2RS	58/GE80ES	58/GE80ES-2RS
	130	75	14	GEG				58/GEH80ES-2RS



Rotules axiales

d	D	H	α	
20	55	20	5	58/GX20F
25	62	22,5	5	58/GX25F
30	75	26	5	58/GX30F
35	90	28	5	58/GX35F
40	105	32	6	58/GX40F
45	120	36,5	6	58/GX45F
50	130	42,5	6	58/GX50F
60	150	45	6	58/GX60F
70	160	50	3	58/GX70F
80	180	50	4	58/GX80F

