

NON ORIGINAL REPLACEMENT PARTS FOR :
SAME-LAMBORGHINI-HÜRLIMANN

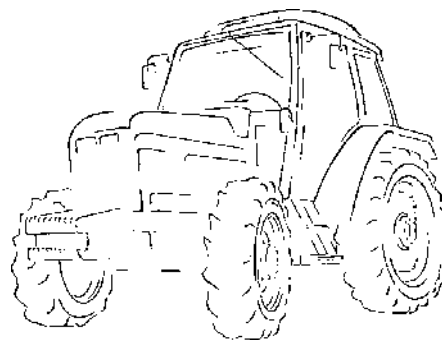

SAME

LAMBORGHINI

HÜRLIMANN

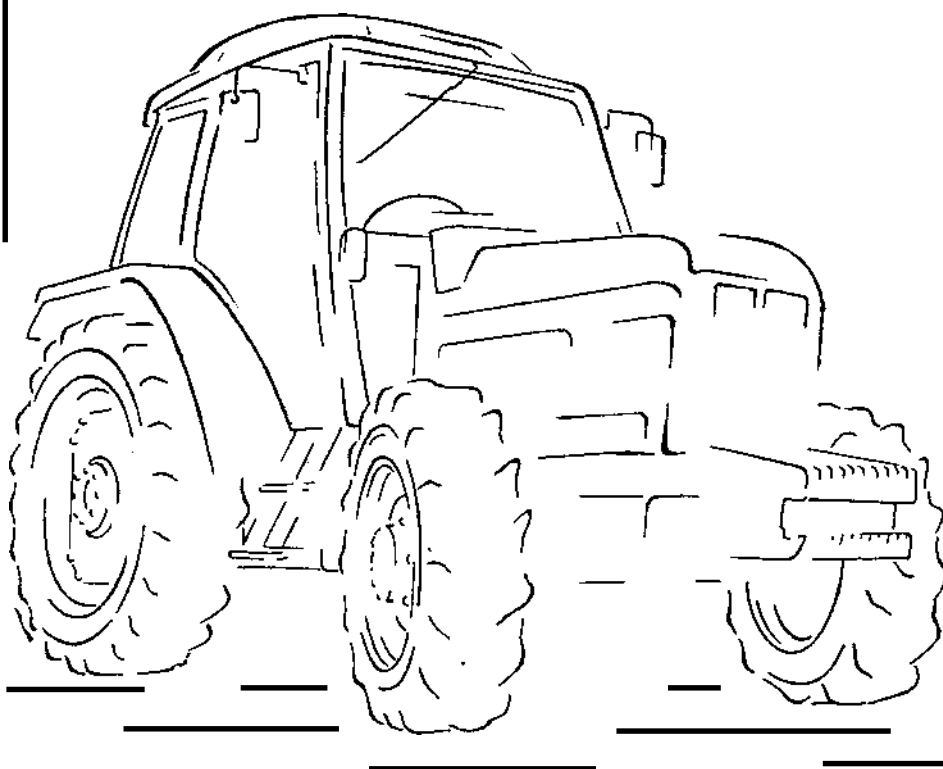

NEW/29/2.0-FE

INDEX

| | |
|---|---|
| ALTERNATEURS 75-76 | ALTERNATORS 75-76 |
| BAGUES D'ETANCHEITE 83 | BEARINGS (AIR COOLING) 1 |
| BOUGIES DE PRECHAUFFAGE 11 | BRAKES 58-63 |
| BOUTONS POUSSOIRS 41 | BUTTONS 41 |
| CONTACTEURS DIVERS 15 | CABS ELEMENTS 80 |
| COURROIES DE VENTILATEUR 14 | CLUTCH ASSEMBLIES & PLATES 45-55 |
| COUSSINETS (REFROIDISSEMENT PAR AIR) 1 | COVER SEAL 83 |
| DEMARREURS 77 | ENGINE GASKET & BEARINGS SETS (WATER COOLING) 2 |
| DISTRIBUTEURS HYDRAULIQUES 73 | ENGINE GASKET SETS (AIR COOLING) 7-8 |
| ECHAPPEMENTS 35 | FAN BELTS 14 |
| ECLAIRAGE - FEUX ARRIÈRES 39 | FILTERS 16-34 |
| ECLAIRAGE - FEUX DE POSITION & CLIGNOTANTS 38 | FLANGE & SPLINED AXLES 65 |
| ECLAIRAGE - PHARES AVANTS 36-37 | FUEL PUMPS & REPAIR KITS 9-10 |
| ECLAIRAGE - PHARES DE TRAVAIL 40 | GAS STRUTS 81-82 |
| ELEMENTS DE CABINES 80 | HEATER PLUGS 11 |
| ETAIS A GAZ 81-82 | HYDRAULIC PUMPS 70-72 |
| FILTRATION 16-34 | HYDRAULIC VALVE 73 |
| FLASQUE & MANCHONS CANNELES 65 | INJECTOR NOZZLES 11 |
| FREINAGE 58-63 | INSTRUMENTS (MISCELLANEOUS) 42-44 |
| INSTRUMENTS DE BORD 42-44 | LIFTING RODS 74 |
| JOINTS & COUSSINETS DE MOTEUR (EAU) 2 | LIGHTING - REAR LIGHTS 39 |
| JOINTS DE MOTEUR (AIR) 7-8 | LIGHTING - FRONT LIGHT 36-37 |
| KITS DE DIRECTION ASSISTEE 65 | LIGHTING - PLOUGH LAMPS 40 |
| MAITRE CYLINDRE 50 | LIGHTING - SIDE LIGHTS & INDICATORS 38 |
| MECANISMES ET DISQUES D'EMBRAYAGE 45-55 | MASTER & SLAVE CYLINDERS (CLUTCHES) 50 |
| NEZ D'INJECTEURS 11 | MISCELLANEOUS PARTS FOR «BOSCH» GENERATOR 76 |
| PEINTURE 79 | MISCELLANEOUS PARTS FOR ORIGINAL ALTERNATORS 76 |
| PIECES DE RECHANGE POUR DEMARREURS «BOSCH» 78 | PAINT 79 |
| PIECES DETACHEES POUR EMBRAYAGES VALEO 56 | PISTONS, ... (WATER COOLING) 5-6 |
| PIECES DIVERSES POUR ALTERNATEURS D'ORIGINE 76 | PISTONS, ... (AIR COOLING) 3-4 |
| PIECES DIVERSES POUR DYNAMO «BOSCH» 76 | POWER STEERING KITS 65 |
| PISTONS, ... (REFROIDISSEMENT PAR AIR) 3-4 | PTO DRIVE 57 |
| PISTONS, ... (REFROIDISSEMENT PAR EAU) 5-6 | REPLACEMENT PARTS FOR VALEO CLUTCHES 56 |
| POMPES A EAU 12-13 | SEAT 79 |
| POMPES D'ALIMENTATION & KITS DE REPARATION 9-10 | SILENCERS 35 |
| POMPES HYDRAULIQUES 70-72 | SPARE PARTS FOR «BOSCH» STARTER MOTORS 78 |
| PTO 57 | STABILISERS 73 |
| ROTULES & TIRANTS DE DIRECTION 66-69 | STARTER MOTORS 77 |
| SIÈGE 79 | STEERING LINKS & SOCKETS 66-69 |
| STABILISATEURS 73 | SWITCHES (MISCELLANEOUS) 15 |
| TIRANTS DE RELEVAGE 74 | TRANSMISSION 64 |
| TRANSMISSION 64 | WATER PUMPS 12-13 |

Les références des pièces sont indicatives.
Nos pièces ne sont pas d'origine.

Part numbers are quoted for reference purposes only.
Our parts and accessories are not original.



"THE RELIABLE SERVICE"



VILEBREQUINS & PIÈCES CONNEXES
CRANKSHAFT & RELATED PARTS

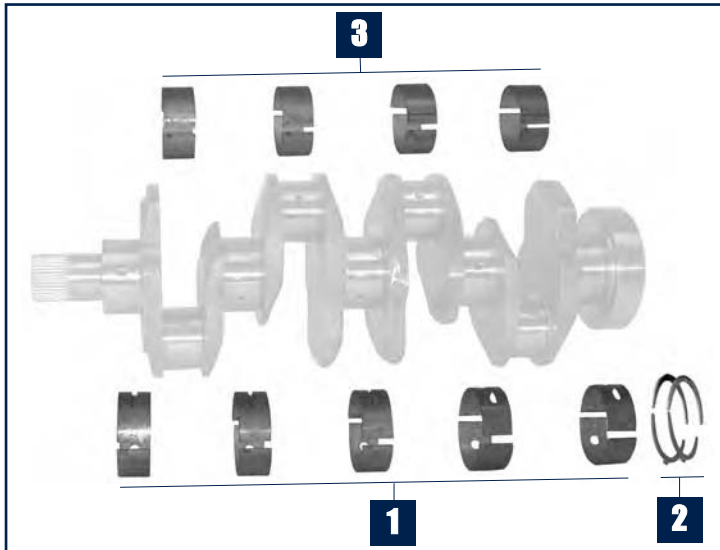

Same

| Tracteurs Tractors | Type Type | Cous. palier Main bearing | Ep. latérale Trust washer | Cous. bielle Conrod bearing | Bague de bielle Small end bush | Bague avant Front oil seal | Bague arrière Rear oil seal |
|---|--------------|--|-------------------------------|--|-----------------------------------|---|---|
| | | 1 | 2 | 3 | 4 | 5 | 6 |
| Moteurs 4 cylindres / 4 cylinder engines | | | | | | | |
| Row Crop 100 | 1000.4WT | 29/7-404 (1x 0.065.1215.0 1x 0.065.1216.0) | 29/6-404 (4x 0.065.1218.0) | 29/9-404 (2x 0.065.1225.0) | 29/28-404 (2.1559.114.0/10) | 29/11-404 (2.1529.141.0) 70 x 90 x 12 | 29/13-404 (2.1529.073.0) 110 x 130 x 13 |
| Moteurs 6 cylindres / 6 cylinder engines | | | | | | | |
| Diamond 230, 260 Diamond II 230, 260 (A): sans/less intercooler (B): avec/with intercooler | BF6M1013 | 29/7-405 (02929430) | 29/6-405 (02929438) | 32/9-405 (A) (02929434) 32/9-406 (B) (02931473 02931297) | 29/28-405 (04200024) | 29/11-405 (04253373) | 29/13-405 (04253333) |
| Rubin 120, 135 Silver 110, 130 | 1000.6WT | 29/7-404 (1x 0.065.1215.0 1x 0.065.1216.0) | 29/6-404 (4x 0.065.1218.0) | 29/9-404 (2x 0.065.1225.0) | 29/28-404 (2.1559.114.0/10) | 29/11-404 (2.1529.141.0) 70 x 90 x 12 | 29/13-404 (2.1529.073.0) 110 x 130 x 13 |
| Rubin 150, 160 Rubin 160 Galileo Silver 160, 180 Titan 150 (⇒ 3001) Titan 160, 190 | 1000.6WT | | | | 29/28-403 (2.1559.255.0) | | |
| Rubin 180, 200 Rubin 180, 200 Galileo Titan 165, 190 (⇒ 3001) Supertitan | 1000.6WTI | | | | | | |

Les références des pièces sont indicatives.
Nos pièces ne sont pas d'origine

Part numbers are quoted for reference purposes only.
Our parts and accessories are not original.

VILEBREQUINS & PIECES CONNEXES CRANKSHAFT & RELATED PARTS

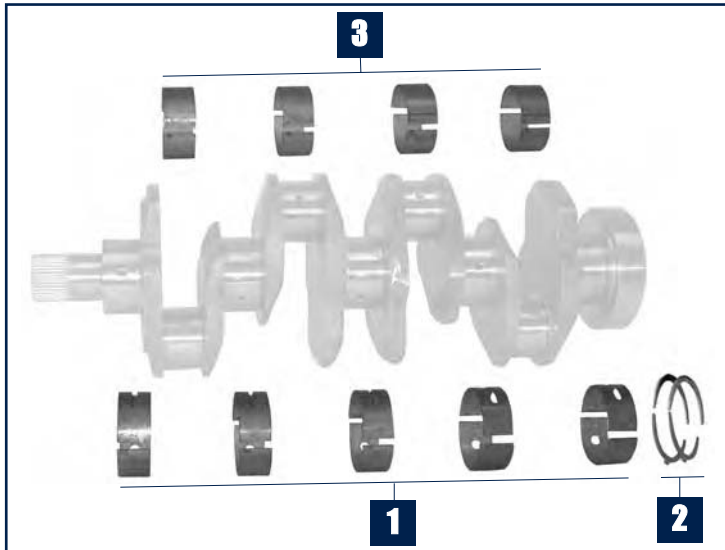

Lamborghini

| Tracteurs Tractors | Type Type | Cous. palier Main bearing | Ep. latérale Trust washer | Cous. bielle Conrod bearing | Bague de bielle Small end bush | Bague avant Front oil seal | Bague arrière Rear oil seal |
|--|--------------|---|--------------------------------------|--------------------------------------|---------------------------------------|--|--|
| | | 1 | 2 | 3 | 4 | 5 | 6 |
| Moteurs 3 cylindres / 3cylinder engines | | | | | | | |
| Agile 660-s F Plus 775 Sprint 654-55, 664-60, 665-65 | 1000.3W | 32/7-404 (1x 0.065.1215.0 1x 0.065.1216.0) | 32/6-404 (4x 0.065.1218.0) | 32/9-404 (2x 0.065.1225.0) | 32/28-404 (2.1559.114.0/10) | 32/11-404 (2.1529.141.0) 70x90x12 | 32/13-404 (2.1529.073.0) 110x130x13 |
| Agile 770-s | 1000.3WT | | | | | | |
| Moteurs 4 cylindres / 4 cylinder engines | | | | | | | |
| C674, C774, R674, R774 | 916.4W | | | | | | |
| 674-70 N, 774-80 N Agile 880-s Cross 674-70 N Ergomatic C 674-70, 774-80 F Plus 880 Grand Prix 674-70, 774-80 Sprint 674-70, 674-75 Triumph 80, 90, 100 | 1000.4W | 32/7-404 (1x 0.065.1215.0 1x 0.065.1216.0) | 32/6-404 (4x 0.065.1218.0) | 32/9-404 (2x 0.065.1225.0) | 32/28-404 (2.1559.114.0/10) | 32/11-404 (2.1529.141.0) 70x90x12 | 32/13-404 (2.1529.073.0) 110x130x13 |
| Agile 990-s Ergomatic C 874-90 F Plus 990 Grand Prix 874-90T Premium 850, 950, 1050 Sprint 684-85 | 1000.4WT | | | | | | |
| Moteurs 6 cylindres / 6 cylinder engines | | | | | | | |
| 956-100 | 916W1 | 32/7-404 | 32/6-404 | 32/9-404 | 32/28-407 | 32/11-404 | 32/13-404 |
| 1106 | 916.6W2 | (1x 0.065.1215.0 1x 0.065.1216.0) | (4x 0.065.1218.0) | (2x 0.065.1225.0) | (0.065.1227.0) | (2.1529.141.0) 70x90x12 | (2.1529.073.0) 110x130x13 |
| 1306 | 916.6WT | | | | | | |
| 1506 | 1106/14 T | 32/7-419 | 32/6-419 | 32/9-419 | 32/28-419 | 32/11-419 | 32/13-419 |
| 1706 | 1106/17 T | (2x 0.073.1215.0) | (2x 0.042.1218.0 2x 0.042.1219.0) | (0.062.1225.0) | (2.1559.144.0/10) | (2.1519.010.0) 58x80x10 | (2.1519.009.0/10) 98x120x13 |

Les références des pièces sont indicatives.
Nos pièces ne sont pas d'origine

"THE RELIABLE SERVICE"

Part numbers are quoted for reference purposes only.
Our parts and accessories are not original.

VILEBREQUINS & PIECES CONNEXES
CRANKSHAFT & RELATED PARTS

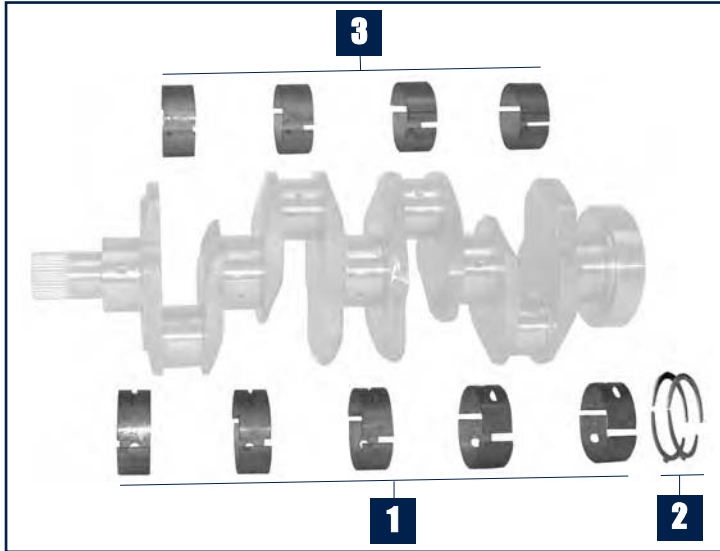

Lamborghini

| Tracteurs Tractors | Type Type | Cous. palier Main bearing | Ep. latérale Trust washer | Cous. bielle Conrod bearing | Bague de bielle Small end bush | Bague avant Front oil seal | Bague arrière Rear oil seal |
|--|--------------|--|-------------------------------|--|-----------------------------------|---|---|
| | | 1 | 2 | 3 | 4 | 5 | 6 |
| Moteurs 6 cylindres / 6 cylinder engines | | | | | | | |
| Formula 115 Premium 1060, 1100 | 1000.6W | 32/7-404 (1x 0.065.1215.0 1x 0.065.1216.0) | 32/6-404 (4x 0.065.1218.0) | 32/9-404 (2x 0.065.1225.0) | 32/28-404 (2.1559.114.0/10) | 32/11-404 (2.1529.141.0) 70x90x12 | 32/13-404 (2.1529.073.0) 110x130x13 |
| Formula 135 Premium 1100, 1300 | 1000.6WT | | | | 32/28-403 (2.1559.255.0) | | |
| Champion 120, 135, 160, 180, 200 Champion Intel Cab 160, 180, 200 Premium 1600, 1800 Racing 150, 165, 190 | 1000.6WT | | | | | | |
| Champion 150 | 1000.6WTI | | | | | | |
| Victory 230, 260 Victory Plus 230, 260 (A): sans/less intercooler (B): avec/with intercooler | BF6M1013 | 32/7-405 (1x 02929430) | 32/6-405 (02929438) | 32/9-405 (A) (02929434) 32/9-406 (B) (02931473 02931297) | 32/28-405 (04200024) | 32/11-405 (04253373) | 32/13-405 (04253333) |

VILEBREQUINS & PIECES CONNEXES CRANKSHAFT & RELATED PARTS

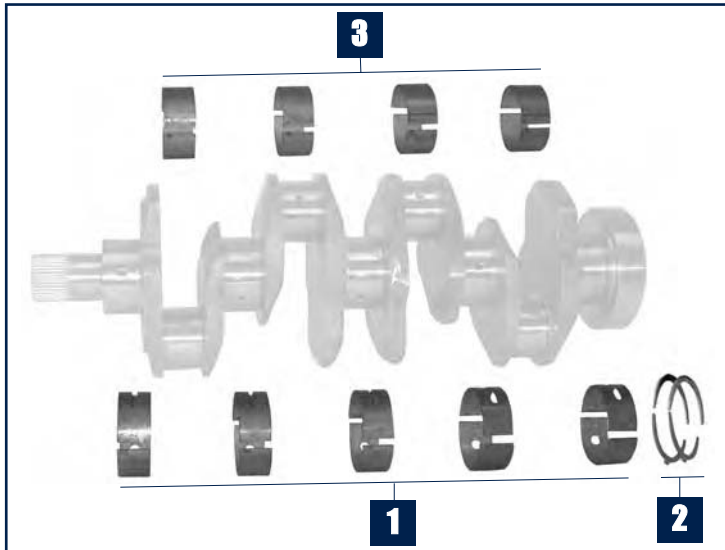

Hürlimann

| Tracteurs Tractors | Type Type | Cous. palier Main bearing | Ep. latérale Trust washer | Cous. bielle Conrod bearing | Bague de bielle Small end bush | Bague avant Front oil seal | Bague arrière Rear oil seal |
|--|--------------|--|-------------------------------|--------------------------------|-----------------------------------|---|---|
| | | 1 | 2 | 3 | 4 | 5 | 6 |
| Moteurs 3 cylindres / 3 cylinder engines | | | | | | | |
| Prestige H-358 XA-606, 655 XN-706 | 1000.3W | 33/7-404 (1x 0.065.1215.0 1x 0.065.1216.0) | 33/6-404 (4x 0.065.1218.0) | 33/9-404 (2x 0.065.1225.0) | 33/28-404 (2.1559.114.0/10) | 33/11-404 (2.1529.141.0) 70x90x12 | 33/13-404 (2.1529.073.0) 110 x 130 x 13 |
| H-476-XF XA-656T XN-707 | 1000.3WT | | | | | | |
| Moteurs 4 cylindres / 4 cylinder engines | | | | | | | |
| Club H468-4 H-478-4 H-481-XF Prestige H-468, 478 XA-607, 657 XN-708 | 1000.4W | 33/7-404 (1x 0.065.1215.0 1x 0.065.1216.0) | 33/6-404 (4x 0.065.1218.0) | 33/9-404 (2x 0.065.1225.0) | 33/28-404 (2.1559.114.0/10) | 33/11-404 (2.1529.141.0) 70x90x12 | 33/13-404 (2.1529.073.0) 110 x 130 x 13 |
| H-491-XF Prestige H-488T XA-658 XN-709 XT-908, 909, 910.4 | 1000.4WT | | | | | | |
| Moteurs 6 cylindres / 6 cylinder engines | | | | | | | |
| Elite 6115-XB | 1000.6W | 33/7-404 (1x 0.065.1215.0 1x 0.065.1216.0) | 33/6-404 (4x 0.065.1218.0) | 33/9-404 (2x 0.065.1225.0) | 33/28-404 (2.1559.114.0/10) | 33/11-404 (2.1529.141.0) 70x90x12 | 33/13-404 (2.1529.073.0) 110 x 130 x 13 |
| Elite 6135-XB SX-1200, 1350 XT-910.6, 911, 913 | 1000.6WT | | | | | | |
| Master H-6165, 6190 Master H.P. SX-1500, 1600, 1800, 2000 | 1000.6WT | | | | 33/28-403 (2.1559.255.0) | | |

Les références des pièces sont indicatives.
Nos pièces ne sont pas d'origine

"THE RELIABLE SERVICE"

Part numbers are quoted for reference purposes only.
Our parts and accessories are not original.

PISTONS, JEUX DE SEGMENTS & CHEMISES
PISTONS, RING SETS & LINERS



1



2



3

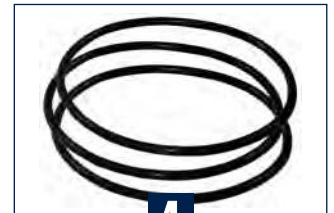

4

Same

| Tracteurs Tractors | Type Type | Piston + segments Piston + rings | Segments Ring set | Chemise Liner | Joint de chemise Liner seals |
|---|--------------|--|--|---|------------------------------------|
| | | 1 | 2 | 3 | 4 |
| Moteurs 4 cylindres / 4 cylinder engines | | | | | |
| Row Crop 100 | 1000.4WT | 29/32-240 (0.087.0060.6/10 0.087.0060.6/30 0.087.0060.A) | 29/34-400 (0.086.0052.6/10) 29/34-401 (0.081.0090.6/10) | 29/35-403 (0.011.0183.0/20 0.B12.2675.0) | 29/38-403 (2.1539.193.0) |
| Moteurs 6 cylindres / 6 cylinder engines | | | | | |
| Diamond 230, 260 | BF6M1013 | 29/32-405 (04253314, 04253386) | 29/34-405 (04207776, 04253389) | 29/35-405 (04203065, 04253771) | 29/38-405 (01181178) |
| Diamond II 230, 260 | BF6M1013 | 29/32-405 (04253314, 04253386) 29/32-406 (04259101) | | 29/35-405 (04203065, 04253771) 29/35-406 (04253772) | |
| Rubin 120 (A): ⇒ 1189 (B): 1190 ⇒ | 1000.6WT | 29/32-401 (A) (0.379.0060.6 0.379.0060.6/10 0.379.0060.A) 29/32-411 (B) (0.382.0060.6 0.382.0060.6/10 0.382.0060.A) Cat. A 29/32-412 (B) (0.382.0060.B) Cat. B | 29/34-400 (0.086.0052.6/10) 29/34-401 (0.081.0090.6/10) | 29/35-402 (0.A12.2675.0) Cat. A 29/35-403 (0.011.0183.0/20 0.B12.2675.0) Cat. B | 29/38-403 (2.1539.193.0) |
| Rubin 135 | 1000.6WT | 29/32-401 (0.379.0060.6 0.379.0060.6/10 0.379.0060.A) Cat. A 29/32-403 (0.379.0060.B) Cat. B | | | |

Les références des pièces sont indicatives.
Nos pièces ne sont pas d'origine

Part numbers are quoted for reference purposes only.
Our parts and accessories are not original.

PISTONS, JEUX DE SEGMENTS & CHEMISES PISTONS, RING SETS & LINERS



1



2

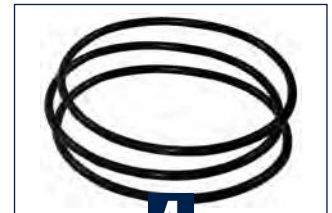

4

Same

| Tracteurs Tractors | Type Type | Piston + segments Piston + rings | Segments Ring set | Chemise Liner | Joints de chemise Liner seals |
|---|--------------|---|--|---|------------------------------------|
| | | 1 | 2 | 3 | 4 |
| Moteurs 6 cylindres / 6 cylinder engines | | | | | |
| Rubin 150, 160 Rubin 160 Galileo | 1000.6WT | 29/32-402 (0.383.0060.6 0.383.0060.A) Cat. A | 29/34-402 (0.338.0052.6 0.338.0052.6/10 0.338.0052.6/20) | 29/35-402 (0.A12.2675.0) Cat. A | 29/38-403 (2.1539.193.0) |
| Rubin 180, 200 Rubin 180, 200 Galileo | 1000.6WTI | 29/32-404 (0.383.0060.B) Cat. B | | 29/35-403 (0.011.0183.0/20 0.B12.2675.0) Cat. B | |
| Silver 110 | 1000.6WT | 29/32-401 (0.379.0060.6 0.379.0060.6/10 0.379.0060.A) | 29/34-400 (0.086.0052.6/10) | 29/35-403 (0.011.0183.0/20 0.B12.2675.0) | |
| Silver 130 | 1000.6WT | 29/32-240 (0.087.0060.6/10 0.087.0060.6/30 0.087.0060.A) | | | |
| Silver 110 (⇒ 3001) | 1000.6WT | 29/32-411 (0.382.0060.6 0.382.0060.6/10 0.382.0060.A) Cat. A 29/32-412 (0.382.0060.B) Cat. B | | 29/34-401 (0.081.0090.6/10) | |
| Silver 130 (⇒ 3001) | 1000.6WT | 29/32-401 (0.379.0060.6 0.379.0060.6/10 0.379.0060.A) Cat. A 29/32-403 (0.379.0060.B) Cat. B | | 29/35-403 (0.011.0183.0/20 0.B12.2675.0) Cat. B | |

PISTONS, JEUX DE SEGMENTS & CHEMISES
PISTONS, RING SETS & LINERS



1



2

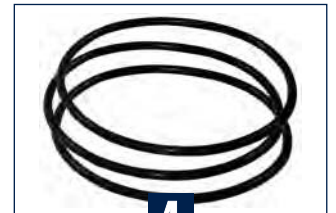

4

Same

| Tracteurs Tractors | Type Type | Piston + segments Piston + rings | Segments Ring set | Chemise Liner | Joint de chemise Liner seals |
|--|--------------|--|--|--|---|
| | | 1 | 2 | 3 | 4 |
| Moteurs 6 cylindres / 6 cylinder engines | | | | | |
| Silver 160, 180 | 1000.6WT | 29/32-402 (0.383.0060.6 0.383.0060.A) Cat. A 29/32-404 (0.383.0060.B) Cat. B | 29/34-402 (0.338.0052.6 0.338.0052.6/10 0.338.0052.6/20) | 29/35-402 (0.A12.2675.0) Cat. A 29/35-403 (0.011.0183.0/20 0.B12.2675.0) Cat. B | 29/38-403 (2.1539.193.0) |
| Titan 150 (⇒ 3001) | 1000.6WT | 29/32-407 (0.340.0060.6 0.340.0060.6/10 0.340.0060.A) | | 29/35-403 (0.011.0183.0/20 0.B12.2675.0) | |
| Titan 165, 190 (⇒ 3001) Supertitan | 1000.6WTI | | | 29/35-400 (A) (0.009.7500.0/10) Cat. A 29/35-401 (B) (0.011.0582.0) Cat. B 29/35-403 (C) (0.011.0183.0/20 0.B12.2675.0) Cat. B | 29/38-400 (D) (2.1519.096.0/20) 29/38-403 (C) (2.1539.193.0) |
| Titan 160 (B): ⇒ 2234 (C): 2235 ⇒ (D): ⇒ 2234 | 1000.6WT | 29/32-407 (0.340.0060.6 0.340.0060.6/10 0.340.0060.A) | 29/34-402 (0.338.0052.6 0.338.0052.6/10 0.338.0052.6/20) | 29/35-400 (A) (0.009.7500.0/10) Cat. A | 29/38-400 (D) (2.1519.096.0/20) 29/38-403 (C) (2.1539.193.0) |
| Titan 190 (A): ⇒ 1592 (B): 1593 ⇒ 2502 (C): 2503 ⇒ (D): ⇒ 2502 | | | | 29/35-401 (B) (0.011.0582.0) Cat. B 29/35-403 (C) (0.011.0183.0/20 0.B12.2675.0) Cat. B | |

PISTONS, JEUX DE SEGMENTS & CHEMISES PISTONS, RING SETS & LINERS

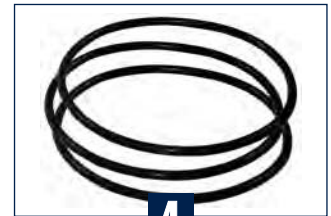

Lamborghini

| Tracteurs Tractors | Type Type | Piston + segments Piston + rings | Segments Ring set | Chemise Liner | Joints de chemise Liner seals |
|--|--------------|---|--|---|---|
| | | 1 | 2 | 3 | 4 |
| Moteurs 3 cylindres / 3 cylinder engines | | | | | |
| Agile 660-s (A): ⇒ 1064 (B): 1242 ⇒ (C): 1065 ⇒ | 1000.3W | 32/32-401 (0.379.0060.6 0.379.0060.6/10 0.379.0060.A) Cat. A | 32/34-400 (0.086.0052.6/10) | 32/35-401 (A) (0.011.0582.0) | 32/38-400 (A) (2.1519.096.0/20) |
| Sprint 654-55 (B): 1051 ⇒ | 1000.3W | 32/32-403 (B) (0.379.0060.B) Cat. B | | 32/35-402 (B) (0.A12.2675.0) Cat. A | |
| Sprint 664-65 (B): 1191 ⇒ | 1000.3W | | | 32/35-403 (C) (0.011.0183.0/20 0.B12.2675.0) Cat. B | 32/38-403 (C) (2.1539.193.0) |
| Agile 770-s (A): ⇒ 1072 (B) 1073 ⇒ | 1000.3WT | 32/32-408 (0.381.0060.6 0.381.0060.6/10 0.381.0060.A) Cat. A | 32/34-402 (0.338.0052.6 0.338.0052.6/10 0.338.0052.6/20) | 32/35-401 (A) (0.011.0582.0) | 32/38-400 (A) (2.1519.096.0/20) |
| | | 32/32-409 (0.381.0060.B) Cat. B | | 32/35-402 (0.A12.2675.0) Cat. A | |
| | | | | 32/35-403 (0.011.0183.0/20 0.B12.2675.0) Cat. B | |

PISTONS, JEUX DE SEGMENTS & CHEMISES
PISTONS, RING SETS & LINERS

1

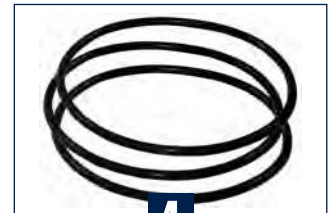
2

4
Lamborghini

| Tracteurs Tractors | Type Type | Piston + segments Piston + rings | Segments Ring set | Chemise Liner | Joint de chemise Liner seals |
|---|--------------|--|--|--|---|
| | | 1 | 2 | 3 | 4 |
| Moteurs 3 cylindres / 3 cylinder engines | | | | | |
| F Plus 775 (A): ⇒ 2348 (B): 2349 ⇒ (C): ⇒ 1465 (D): 1466 ⇒ 2059 (E): 2060 ⇒ (F): ⇒ 2059 | 1000.3W | 32/32-413 (A) (0.338.0060.6/20 0.338.0060.A) Cat. A 32/32-408 (B) (0.381.0060.6 0.381.0060.6/10 0.381.0060.A) Cat. A 32/32-409 (B) (0.381.0060.B) Cat. B | 32/34-402 (0.338.0052.6 0.338.0052.6/10 0.338.0052.6/20) | 32/35-400 (C) (0.009.7500.0/10) Cat. A 32/35-401 (D) (0.011.0582.0) Cat. B 32/35-402 (E) (0.A12.2675.0) Cat. A 32/35-403 (E) (0.011.0183.0/20 0.B12.2675.0) Cat. B | 32/38-400 (F) (2.1519.096.0/20) 32/38-403 (E) (2.1539.193.0) |
| Sprint 664-60 (A): ⇒ 2771 (B): 2771 ⇒ | 1000.3W | 32/32-90 (0.086.0060.6/30) | 32/34-400 (0.086.0052.6/10) | 32/35-400 (0.009.7500.0/10) 32/35-401 (A) (0.011.0582.0) 32/35-403 (B) (0.011.0183.0/20 0.B12.2675.0) | 32/38-400 (A) (2.1519.096.0/20) 32/38-403 (B) (2.1539.193.0) |
| Moteurs 4 cylindres / 4 cylinder engines | | | | | |
| Agile 880-s (A): ⇒ 2376 (B): 2377 ⇒ | 1000.4W | 32/32-401 (0.379.0060.6 0.379.0060.6/10 0.379.0060.A) Cat. A 32/32-403 (0.379.0060.B) Cat. B | 32/34-400 (0.086.0052.6/10) | 32/35-401 (A) (0.011.0582.0) 32/35-402 (B) (0.A12.2675.0) Cat. A 32/35-403 (B) (0.011.0183.0/20 0.B12.2675.0) Cat. B | 32/38-400 (A) (2.1519.096.0/20) 32/38-403 (B) (2.1539.193.0) |

PISTONS, JEUX DE SEGMENTS & CHEMISES PISTONS, RING SETS & LINERS



1



2

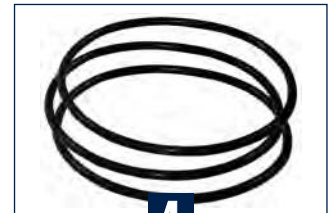

4

Lamborghini

| Tracteurs Tractors | Type Type | Piston + segments Piston + rings | Segments Ring set | Chemise Liner | Joint de chemise Liner seals |
|---|--------------|---|---|--|---|
| | | 1 | 2 | 3 | 4 |
| Moteurs 4 cylindres / 4 cylinder engines | | | | | |
| Agile 990-s (A): ⇒ 1042 (B): 1043 ⇒ | 1000.4WT | 32/32-411 (0.382.0060.6 0.382.0060.6/10 0.382.0060.A) Cat. A 32/32-412 (0.382.0060.B) Cat. B | 32/34-400 (0.086.0052.6/10) 32/34-401 (0.081.0090.6/10) | 32/35-401 (A) (0.011.0582.0) 32/35-402 (0.A12.2675.0) Cat. A 32/35-403 (0.011.0183.0/20 0.B12.2675.0) Cat. B | 32/38-400 (A) (2.1519.096.0/20) 32/38-403 (B) (2.1539.193.0) |
| Cross 674-70 N (A): ⇒ 24943 (B): 24944 ⇒ | 1000.4W | 32/32-400 (0.089.0060.6) | 32/34-400 (0.086.0052.6/10) | 32/35-400 (0.009.7500.0/10) 32/35-401 (A) (0.011.0582.0) 32/35-403 (B) (0.011.0183.0/20 0.B12.2675.0) | |
| Ergomatic 674-70 (A): ⇒ 30080 (B): 30081 ⇒ (C): ⇒ 17701 (D): 17702 ⇒ 24865 (E): 24866 ⇒ (F): ⇒ 24865 Ergomatic 774-80 (A): ⇒ 30463 (B): 30464 ⇒ (C): ⇒ 17701 (D): 17702 ⇒ 24955 (E): 24956 ⇒ (F): ⇒ 24955 F Plus 880 (A): ⇒ 4241 (B): 4242 ⇒ (C): ⇒ 1120 (D): 1121 ⇒ 2448 (E): 2449 ⇒ (F): ⇒ 2448 | 1000.4W | 32/32-90 (A) (0.086.0060.6/30) 32/32-401 (B) (0.379.0060.6 0.379.0060.6/10 0.379.0060.A) Cat. A 32/32-403 (B) (0.379.0060.B) Cat. B | 32/34-400 (0.086.0052.6/10) 32/34-400 (0.086.0052.6/10) 32/34-401 (0.081.0090.6/10) | 32/35-400 (C) (0.009.7500.0/10) Cat. A 32/35-401 (D) (0.011.0582.0) Cat. B 32/35-402 (E) (0.A12.2675.0) Cat. A 32/35-403 (E) (0.011.0183.0/20 0.B12.2675.0) Cat. B | 32/38-400 (F) (2.1519.096.0/20) 32/38-403 (E) (2.1539.193.0) |

Les références des pièces sont indicatives.
Nos pièces ne sont pas d'origine

"THE RELIABLE SERVICE"

Part numbers are quoted for reference purposes only.
Our parts and accessories are not original.

PISTONS, JEUX DE SEGMENTS & CHEMISES
PISTONS, RING SETS & LINERS

Lamborghini

| Tracteurs Tractors | Type Type | Piston + segments Piston + rings | Segments Ring set | Chemise Liner | Joint de chemise Liner seals |
|---|--------------|---|--|--|---|
| | | 1 | 2 | 3 | 4 |
| Moteurs 4 cylindres / 4 cylinder engines | | | | | |
| Ergomatic 874-90 Turbo (A): ⇒ 8736 (B): 8737 ⇒ (C): ⇒ 1852 (D): 1853 ⇒ 6848 (E): 6849 ⇒ (F): ⇒ 6848 F Plus 990 (A): ⇒ 4148 (B): 4149 ⇒ (C): ⇒ 1439 (D): 1440 ⇒ 2714 (E): 2715 ⇒ (F): ⇒ 2714 | 1000.4WT | 32/32-240 (A) (0.087.0060.6/10 0.087.0060.6/30 0.087.0060.A) Cat. A 32/32-411 (B) (0.382.0060.6 0.382.0060.6/10 0.382.0060.A) Cat. A 32/32-412 (B) (0.382.0060.B) Cat. B | 32/34-400 (0.086.0052.6/10) 32/34-401 (0.081.0090.6/10) | 32/35-400 (C) (0.009.7500.0/10) 32/35-401 (D) (0.011.0582.0) 32/35-402 (E) (0.A12.2675.0) Cat. A 32/35-403 (E) (0.011.0183.0/20 0.B12.2675.0) Cat. B | 32/38-400 (F) (2.1519.096.0/20) 32/38-403 (E) (2.1539.193.0) |
| 674-70N (B-D): ⇒ 24952 (C): 24953 ⇒ 774-80N (B-D): ⇒ 25099 (C): 25100 ⇒ Grand Prix 674-70 (A): ⇒ 17700 (B): 17701 ⇒ 25065 (C): 25066 ⇒ (D): ⇒ 25065 Grand Prix 774-80 (A): ⇒ 17700 (B): 17701 ⇒ 24928 (C): 24929 ⇒ (D): ⇒ 24928 Sprint 674-70 (B-D): ⇒ 24631 (C): 24632 ⇒ Premium 850 (A): ⇒ 1015 (B): 1016 ⇒ 2403 (C): 2404 ⇒ (D): ⇒ 2403 | 1000.4W | 32/32-90 (0.086.0060.6/30) | 32/34-400 (0.086.0052.6/10) | 32/35-400 (A) (0.009.7500.0/10) Cat. A 32/35-401 (B) (0.011.0582.0) Cat. B 32/35-403 (C) (0.011.0183.0/20 0.B12.2675.0) Cat. B | 32/38-400 (D) (2.1519.096.0/20) 32/38-403 (C) (2.1539.193.0) |

PISTONS, JEUX DE SEGMENTS & CHEMISES PISTONS, RING SETS & LINERS



1



2

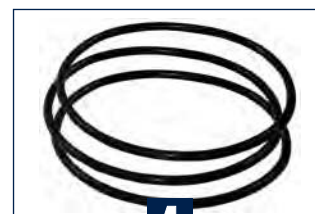

4

Lamborghini

| Tracteurs Tractors | Type Type | Piston + segments Piston + rings | Segments Ring set | Chemise Liner | Joints de chemise Liner seals |
|---|--------------|---|---------------------------------------|---|---|
| | | 1 | 2 | 3 | 4 |
| Moteurs 4 cylindres / 4 cylinder engines | | | | | |
| Grand Prix 874-90T (A): ⇒ 5428 (B): 5429 ⇒ 6740 (C): 6741 ⇒ (D): ⇒ 6740 | 1000.4WT | 32/32-240 (0.087.0060.6/10 0.087.0060.6/30 0.087.0060.A) | | 32/35-400 (A) (0.009.7500.0/10) Cat. A | 32/38-400 (D) (2.1519.096.0/20) 32/38-403 (C) (2.1539.193.0) |
| Premium 950 (A): ⇒ 1018 (B): 1019 ⇒ 2528 (C): 2529 ⇒ (D): ⇒ 2528 | | | | 32/35-401 (B) (0.011.0582.0) Cat. B | |
| Premium 1050 (B-D): ⇒ 52204 (C): 52205 ⇒ | | | | 32/35-403 (C) (0.011.0183.0/20 0.B12.2675.0) Cat. B | |
| High Clearance 90 | 1000.4WT | | 32/34-400 (0.086.0052.6/10) | 32/35-403 (0.011.0183.0/20 0.B12.2675.0) | |
| Sprint 674-75 | 1000.4W | 32/32-401 (0.379.0060.6 0.379.0060.6/10 0.379.0060.A) Cat. A | 32/34-401 (0.081.0090.6/10) | 32/35-402 (0.A12.2675.0) Cat. A | |
| Sprint 684-85 | 1000.4WT | 32/32-403 (0.379.0060.B) Cat. B | | 32/35-403 (0.011.0183.0/20 0.B12.2675.0) Cat. B | 32/38-403 (2.1539.193.0) |
| Triumph 80 | 1000.4W | 32/32-401 (0.379.0060.6 0.379.0060.6/10 0.379.0060.A) | | | |
| Triumph 90, 100 | 1000.4W | 32/32-*** (0.007.1787.4/20) | | | |

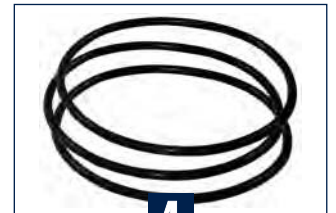
PISTONS, JEUX DE SEGMENTS & CHEMISES
PISTONS, RING SETS & LINERS

Lamborghini

| Tracteurs Tractors | Type Type | Piston + segments Piston + rings | Segments Ring set | Chemise Liner | Joint de chemise Liner seals |
|--|--------------|---|--|--|---|
| | | 1 | 2 | 3 | 4 |
| Moteurs 6 cylindres / 6cylinder engines | | | | | |
| 956-100 (A): ⇒ 3528 (B): 3529 ⇒ 3642 (C): 3643 ⇒ (D): ⇒ 3642 | 916W1 | 32/32-414 (0.069.0060.6) | 32/34-414 (0.069.0052.6) | 32/35-414 (A) (0.066.1120.0/20) | 32/38-400 (D) (2.1519.096.0/20) 32/38-403 (C) (2.1539.193.0) |
| 1106 (A): ⇒ 1463 (B): 1464 ⇒ 1965 (C): 1966 ⇒ (D): ⇒ 1965 | 916.6W2 | | | | |
| 1306 (A): ⇒ 1764 (B): 1765 ⇒ 1802 (C): 1803 ⇒ (D): ⇒ 1802 | 916.6WT | | | | |
| 1506 | 1106/14T | 32/32-417 (0.064.0060.6) | 32/34-417 (0.064.0051.6) | 32/35-417 (0.057.1120.0) | 32/38-417 (2.1539.029.0) |
| 1706 | 1106/17T | | | | |
| Champion 120, 135 | 1000.6WT | 32/32-418 (0.392.0060.A) Cat. A | 32/34-402 (0.338.0052.6 0.338.0052.6/10 0.338.0052.6/20) | 32/35-402 (0.A12.2675.0) Cat. A | 32/38-403 (2.1539.193.0) |
| Champion 150 | 1000.6WTI | 32/32-419 (0.392.0060.B) Cat. B | | | |
| Champion 160, 180, 200 Champion 180 Intel-Cab | 1000.6WT | 32/32-420 (0.098.0060.A 0.098.0060.6/10) | | | |
| Champion 160 Intel-Cab 1002 ⇒ Champion 200 Intel-Cab 1005 ⇒ | 1000.6WT | | | | |

PISTONS, JEUX DE SEGMENTS & CHEMISES PISTONS, RING SETS & LINERS



1



2

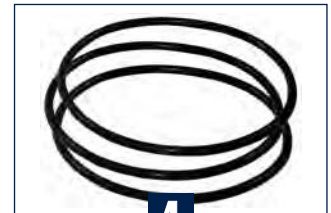

4

Lamborghini

| Tracteurs Tractors | Type Type | Piston + segments Piston + rings | Segments Ring set | Chemise Liner | Joints de chemise Liner seals |
|---|--------------|---|--|---|---|
| | | 1 | 2 | 3 | 4 |
| Moteurs 6 cylindres / 6cylinder engines | | | | | |
| Formula 115 (A): ⇒ 2086 (B): 2087 ⇒ 2817 (C): 2818 ⇒ (D): ⇒ 2817 | 1000.6W | 32/32-90 (0.086.0060.6/30) | 32/34-400 (0.086.0052.6/10) | 32/35-400 (A) (0.009.7500.0/10) Cat. A | 32/38-400 (D) (2.1519.096.0/20) 32/38-403 (C) (2.1539.193.0) |
| Premium 1060 (A): ⇒ 1024 (B): 1025 ⇒ 2828 (C): 2829 ⇒ (D): ⇒ 2828 | | | | 32/35-401 (B) (0.011.0582.0) Cat. B | |
| Formula 135 (A): ⇒ 1936 (B): 1937 ⇒ 3094 (C): 3095 ⇒ (D): ⇒ 3094 | 1000.6WT | 32/32-240 (0.087.0060.6/10 0.087.0060.6/30 0.087.0060.A) | 32/34-400 (0.086.0052.6/10) 32/34-401 (0.081.0090.6/10) | 32/35-403 (C) (0.011.0183.0/20 0.B12.2675.0) Cat. B | 32/38-403 (2.1539.193.0) |
| Premium 1100 | 1000.6WT | 32/32-401 (0.379.0060.6 0.379.0060.6/10 0.379.0060.A) | | 32/35-403 (0.011.0183.0/20 0.B12.2675.0) | |
| Premium 1300 | 1000.6WT | 32/32-240 (0.087.0060.6/10 0.087.0060.6/30 0.087.0060.A) | | 32/35-402 (0.011.0183.0/20 0.B12.2675.0) Cat. A | |
| Premium 1100 (⇒ 3001) | 1000.6WT | 32/32-411 (0.382.0060.6 0.382.0060.6/10 0.382.0060.A) Cat. A 32/32-412 (0.382.0060.B) Cat. B | | 32/35-403 (0.011.0183.0/20 0.B12.2675.0) Cat. B | |
| Premium 1300 (⇒ 3001) | 1000.6WT | 32/32-401 (0.379.0060.6 0.379.0060.6/10 0.379.0060.A) Cat. A 32/32-403 (0.379.0060.B) Cat. B | | | |

Les références des pièces sont indicatives.
Nos pièces ne sont pas d'origine

"THE RELIABLE SERVICE"

Part numbers are quoted for reference purposes only.
Our parts and accessories are not original.

PISTONS, JEUX DE SEGMENTS & CHEMISES
PISTONS, RING SETS & LINERS



1



2

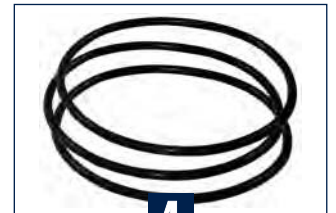

4

Lamborghini

| Tracteurs Tractors | Type Type | Piston + segments Piston + rings | Segments Ring set | Chemise Liner | Joint de chemise Liner seals |
|--|--------------|--|---|--|---|
| | | 1 | 2 | 3 | 4 |
| Moteurs 6 cylindres / 6cylinder engines | | | | | |
| Premium 1600, 1800 | 1000.6WT | 32/32-402 (0.383.0060.6 0.383.0060.A) Cat. A 32/32-404 (0.383.0060.B) Cat. B | 32/34-402 (0.338.0052.6 0.338.0052.6/10 0.338.0052.6/20) | 32/35-402 (0.A12.2675.0) Cat. A 32/35-403 (0.011.0183.0/20 0.B12.2675.0) Cat. B | 32/38-403 (2.1539.193.0) |
| Racing 150 (A): ⇒ 2228 (B): 2229 ⇒ | 1000.6WT | 32/32-407 (0.340.0060.6 0.340.0060.6/10 0.340.0060.A) | | 32/35-401 (A) (0.011.0582.0) 32/35-403 (B) (0.011.0183.0/20 0.B12.2675.0) | 32/38-400 (A) (2.1519.096.0/20) 32/38-403 (B) (2.1539.193.0) |
| Racing 150, 165, 190 (⇒ 3001) Racing Hi. Per. | 1000.6WT | | | 32/35-403 (0.011.0183.0/20 0.B12.2675.0) | 32/38-403 (2.1539.193.0) |
| Racing 165 (A): ⇒ 1471 (B): 1472 ⇒ 2229 (C): 2230 ⇒ (D): ⇒ 2229 Racing 190 (A): ⇒ 1593 (B): 1594 ⇒ 2532 (C): 2533 ⇒ (D): ⇒ 2532 | 1000.6WT | | | 32/35-400 (A) (0.009.7500.0/10) Cat. A 32/35-401 (B) (0.011.0582.0) Cat. B 32/35-403 (C) (0.011.0183.0/20 0.B12.2675.0) Cat. B | 32/38-400 (D) (2.1519.096.0/20) 32/38-403 (C) (2.1539.193.0) |
| Victory 230, 260 | BF6M1013 | 32/32-405 (04253314, 04253386) | | 32/34-405 (04207776, 04253389) | 32/35-405 (04203065, 04253771) |
| Victory Plus 230, 260 | BF6M1013 | 32/32-405 (04253314, 04253386) 32/32-406 (04259101) | 32/35-405 (04203065, 04253771) 32/35-406 (04253772) | | |

Les références des pièces sont indicatives.
Nos pièces ne sont pas d'origine

Part numbers are quoted for reference purposes only.
Our parts and accessories are not original.

PISTONS, JEUX DE SEGMENTS & CHEMISES PISTONS, RING SETS & LINERS



1



2

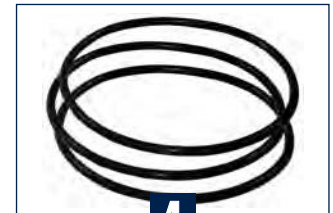

4

Hürlimann

| Tracteurs Tractors | Type Type | Piston + segments Piston + rings | Segments Ring set | Chemise Liner | Joints de chemise Liner seals |
|---|--------------|--|--|--|---|
| | | 1 | 2 | 3 | 4 |
| Moteurs 3 cylindres / 3 cylinder engines | | | | | |
| H-476-XF (A): ⇒ 2347 (B): 2348 ⇒ (C): ⇒ 1465 (D): 1466 ⇒ 2012 (E): 2013 ⇒ (F): ⇒ 2012 | 1000.3WT | 33/32-413 (A) (0.338.0060.6/20 0.338.0060.A) 33/32-408 (B) (0.381.0060.6 0.381.0060.6/10 0.381.0060.A) 33/32-409 (B) (0.381.0060.B) | 33/34-402 (0.338.0052.6 0.338.0052.6/10 0.338.0052.6/20) | 33/35-400 (C) (0.009.7500.0/10) 33/35-401 (D) (0.011.0582.0) 33/35-402 (E) (0.A12.2675.0) 33/35-403 (E) (0.011.0183.0/20 0.B12.2675.0) | 33/38-400 (F) 2.1519.096.0/20 33/38-403 (E) 2.1539.193.0 |
| Prestige H-358 (A): ⇒ 1628 (B): 1629 ⇒ ... (C): ... ⇒ (D): ⇒ ... XA-606 (A) ⇒ ... (B) ... ⇒ 2774 (C): 2775 ⇒ (D): ⇒ 2774 | 1000.3W | 33/32-90 (0.086.0060.6/30) | 33/34-400 (0.086.0052.6/10) | 33/35-400 (A) (0.009.7500.0/10) 33/35-401 (B) (0.011.0582.0) 33/35-403 (C) (0.011.0183.0/20 0.B12.2675.0) | 33/38-400 (D) 2.1519.096.0/20 33/38-403 (C) 2.1539.193.0 |
| XA-655 | 1000.3W | 33/32-401 (0.379.0060.6 0.379.0060.6/10 0.379.0060.A) | 32/34-400 (0.086.0052.6/10) 32/34-401 (0.081.0090.6/10) | 33/35-402 (0.A12.2675.0) | 33/38-403 (2.1539.193.0) |
| XA-656T | 1000.3WT | | | 33/35-403 (0.011.0183.0/20 0.B12.2675.0) | |
| XN-706 (A): (B): (C): (D): | 1000.3W | 33/32-403 (0.379.0060.B) | | 33/35-401 (A) (0.011.0582.0) 33/35-402 (B) (0.A12.2675.0) | 33/38-400 (D) 2.1519.096.0/20 |
| XN-707 (A): (B): (C): (D): | 1000.3WT | 33/32-408 (0.381.0060.6 0.381.0060.6/10 0.381.0060.A) 33/32-409 (0.381.0060.B) | 33/34-402 (0.338.0052.6 0.338.0052.6/10 0.338.0052.6/20) | 33/35-403 (C) (0.011.0183.0/20 0.B12.2675.0) | 33/38-403 (C) 2.1539.193.0 |

Les références des pièces sont indicatives.
Nos pièces ne sont pas d'origine

"THE RELIABLE SERVICE"

Part numbers are quoted for reference purposes only.
Our parts and accessories are not original.

PISTONS, JEUX DE SEGMENTS & CHEMISES
PISTONS, RING SETS & LINERS

1

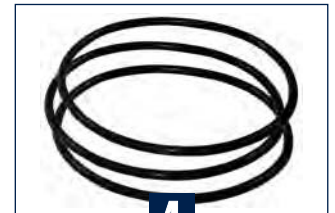
2

4
Hürlimann

| Tracteurs Tractors | Type Type | Piston + segments Piston + rings | Segments Ring set | Chemise Liner | Joint de chemise Liner seals |
|---|--------------|--|--|--|---|
| | | 1 | 2 | 3 | 4 |
| Moteurs 4 cylindres / 4 cylinder engines | | | | | |
| H-468-4 (B-D): ⇒ 25198 (C): 25199 ⇒ | 1000.4W | 33/32-400 (0.089.0060.6) | | | |
| H-478-4 (B-D): ⇒ 25080 (C): 25081 ⇒ Prestige H-468 (A): ⇒ 17700 (B): 17701 ⇒ 25055 (C): 25056 ⇒ (D): ⇒ 25055 Prestige H-478 (A): ⇒ 17700 (B): 17701 ⇒ 24932 (C): 24933 ⇒ (D): ⇒ 24932 XA-607 (B-D): ⇒ 24989 (C): 24990 ⇒ | 1000.4W | 33/32-90 (0.086.0060.6/30) | 33/34-400 (0.086.0052.6/10) | 33/35-400 (A) (0.009.7500.0/10) 33/35-401 (B) (0.011.0582.0) 33/35-403 (C) (0.011.0183.0/20 0.B12.2675.0) | 33/38-400 (D) (2.1519.096.0/20) 33/38-403 (C) (2.1539.193.0) |
| XT-908 (A): ⇒ 1015 (B): 1016 ⇒ 2479 (C): 2480 ⇒ (D): ⇒ 2479 | 1000.4WT | | | | |
| Prestige H-488T (A): ⇒ 1851 (B): 1852 ⇒ 1936 (C): 1937 ⇒ (D): ⇒ 1936 XT-909 (A): ⇒ 1018 (B): 1019 ⇒ 2451 (C): 2452 ⇒ (D): ⇒ 2451 XT-910.4 (B-D): ⇒ 52259 (C): 52260 ⇒ | 1000.4WT | 33/32-240 (0.087.0060.6/10 0.087.0060.6/30 0.087.0060.A) | 32/34-400 (0.086.0052.6/10) 32/34-401 (0.081.0090.6/10) | | |

PISTONS, JEUX DE SEGMENTS & CHEMISES PISTONS, RING SETS & LINERS



1



2

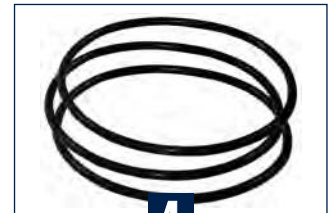

4

Hürlimann

| Tracteurs Tractors | Type Type | Piston + segments Piston + rings | Segments Ring set | Chemise Liner | Joints de chemise Liner seals |
|---|---------------------|---|--|--|---|
| | | 1 | 2 | 3 | 4 |
| Moteurs 4 cylindres / 4 cylinder engines | | | | | |
| H-481-XF (A): ⇒ 4230 (B): 4231 ⇒ (C): ⇒ 1120 (D): 1121 ⇒ 2437 (E): 2438 ⇒ (F): ⇒ 2437 | 1000.4WT | 33/32-90 (A) (0.086.0060.6/30) 33/32-401 (B) (0.379.0060.6 0.379.0060.6/10 0.379.0060.A) 33/32-403 (B) (0.379.0060.B) | 33/34-400 (0.086.0052.6/10) | 33/35-400 (C) (0.009.7500.0/10) 33/35-401 (D) (0.011.0582.0) 33/35-402 (E) (0.A12.2675.0) 33/35-403 (E) (0.011.0183.0/20 0.B12.2675.0) | 33/38-400 (F) 2.1519.096.0/20 33/38-403 (E) 2.1539.193.0 |
| H-491-XF (A): ⇒ 4141 (B): 4142 ⇒ (C): ⇒ 1439 (D): 1440 ⇒ 2688 (E): 2689 ⇒ (F): ⇒ 2688 | 1000.4WT | 33/32-240 (0.087.0060.6/10 0.087.0060.6/30 0.087.0060.A) 33/32-411 (0.382.0060.6 0.382.0060.6/10 0.382.0060.A) 33/32-412 (0.382.0060.B) | 33/34-400 (0.086.0052.6/10) 33/34-401 (0.081.0090.6/10) | 33/35-402 (0.A12.2675.0) 33/35-403 (0.011.0183.0/20 0.B12.2675.0) | 33/38-403 (2.1539.193.0) |
| XA-657 XA-658 | 1000.4W 1000.4WT | 33/32-401 (0.379.0060.6 0.379.0060.6/10 0.379.0060.A) | | 33/35-402 (0.A12.2675.0) 33/35-403 (0.011.0183.0/20 0.B12.2675.0) | 33/38-403 (2.1539.193.0) |
| XN-708 (A): ⇒ 1018 (B): 1019 ⇒ | 1000.4W | 33/32-403 (0.379.0060.B) | | 33/35-401 (A) (0.011.0582.0) | 33/38-400 (A) 2.1519.096.0/20 |
| XN-709 (A): ⇒ 1013 (B): 1014 ⇒ | 1000.4WT | 33/32-411 (0.382.0060.6 0.382.0060.6/10 0.382.0060.A) 33/32-412 (0.382.0060.B) | | 33/35-402 (0.A12.2675.0) 33/35-403 (0.011.0183.0/20 0.B12.2675.0) | 33/38-403 (B) 2.1539.193.0 |

PISTONS, JEUX DE SEGMENTS & CHEMISES
PISTONS, RING SETS & LINERS



1



2

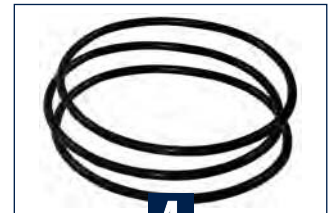

4

Hürlimann

| Tracteurs Tractors | Type Type | Piston + segments Piston + rings | Segments Ring set | Chemise Liner | Joint de chemise Liner seals |
|--|--------------|---|--|--|---|
| | | 1 | 2 | 3 | 4 |
| Moteurs 6 cylindres / 6 cylinder engines | | | | | |
| Elite 6115-XB (A): ⇒ 2086 (B): 2087 ⇒ 2808 (C): 2809 ⇒ (D): ⇒ 2808 | 1000.6W | 33/32-90 (0.086.0060.6/30) | 33/34-400 (0.086.0052.6/10) | 33/35-400 (A) (0.009.7500.0/10) 33/35-401 (B) (0.011.0582.0) 33/35-403 (C) (0.011.0183.0/20 0.B12.2675.0) | 33/38-400 (D) 2.1519.096.0/20 33/38-403 (C) 2.1539.193.0 |
| XT-910.6 (A): ⇒ 1024 (B): 1025 ⇒ 2725 (C): 2726 ⇒ (D): ⇒ 2725 | 1000.6WT | | | | |
| Elite 6135-XB (A): ⇒ 1936 (B): 1937 ⇒ 3142 (C): 3143 ⇒ (D): ⇒ 3142 | 1000.6WT | 33/32-240 (0.087.0060.6/10 0.087.0060.6/30 0.087.0060.A) | 33/34-400 (0.086.0052.6/10) 33/34-401 (0.081.0090.6/10) | | |
| Master H-6165 (A): ⇒ 1471 (B): 1472 ⇒ 2195 (C): 2196 ⇒ (D): ⇒ 2195 | 1000.6WT | 33/32-407 (0.340.0060.6 0.340.0060.6/10 0.340.0060.A) | 33/34-402 (0.338.0052.6 0.338.0052.6/10 0.338.0052.6/20) | | |
| Master H-6190 (A): ⇒ 1592 (B): 1593 ⇒ 2523 (C): 2524 ⇒ (D): ⇒ 2523 | 1000.6WT | | | | |
| Master H-6165, 6190 (⇒ 2001) Master H.P. | 1000.6WT | | | 33/35-403 (0.011.0183.0/20 0.B12.2675.0) | |
| SX-1200 XT-911 (⇒ 3001) | 1000.6WT | 33/32-411 (0.382.0060.6 0.382.0060.6/10 0.382.0060.A) 33/32-412 (0.382.0060.B) | 33/34-400 (0.086.0052.6/10) | 33/35-402 (0.A12.2675.0) | 33/38-403 2.1539.193.0 |
| SX-1350 XT-913 (⇒ 3001) | 1000.6WT | 33/32-401 (0.379.0060.6 0.379.0060.6/10 0.379.0060.A) 33/32-403 (0.379.0060.B) | | | |

Les références des pièces sont indicatives.
Nos pièces ne sont pas d'origine

"THE RELIABLE SERVICE"

Part numbers are quoted for reference purposes only.
Our parts and accessories are not original.

PISTONS, JEUX DE SEGMENTS & CHEMISES PISTONS, RING SETS & LINERS



1



2

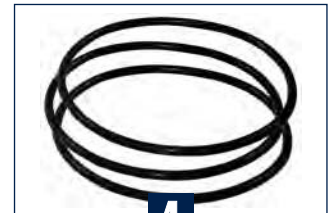

4

Hürlimann

| Tracteurs Tractors | Type Type | Piston + segments Piston + rings | Segments Ring set | Chemise Liner | Joints de chemise Liner seals |
|---|--------------|--|--|---|------------------------------------|
| | | 1 | 2 | 3 | 4 |
| Moteurs 6 cylindres / 6 cylinder engines | | | | | |
| SX-1500, 1600, 1800, 2000 | 1000.6WT | 33/32-402 (0.383.0060.6 0.383.0060.A) 33/32-404 (0.383.0060.B) | 33/34-402 (0.338.0052.6 0.338.0052.6/10 0.338.0052.6/20) | 33/35-402 (0.A12.2675.0) 33/35-403 (0.011.0183.0/20 0.B12.2675.0) | 33/38-403 (2.1539.193.0) |
| XT-911 | 1000.6WT | 33/32-401 (0.379.0060.6 0.379.0060.6/10 0.379.0060.A) | 33/34-400 (0.086.0052.6/10) | 33/35-403 (0.011.0183.0/20 0.B12.2675.0) | |
| XT-913 | 1000.6WT | 33/32-240 (0.087.0060.6/10 0.087.0060.6/30 0.087.0060.A) | 33/34-401 (0.081.0090.6/10) | | |

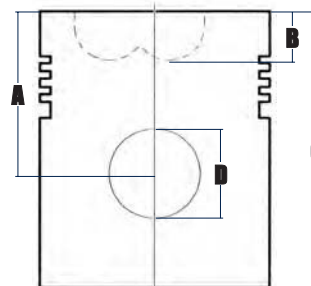
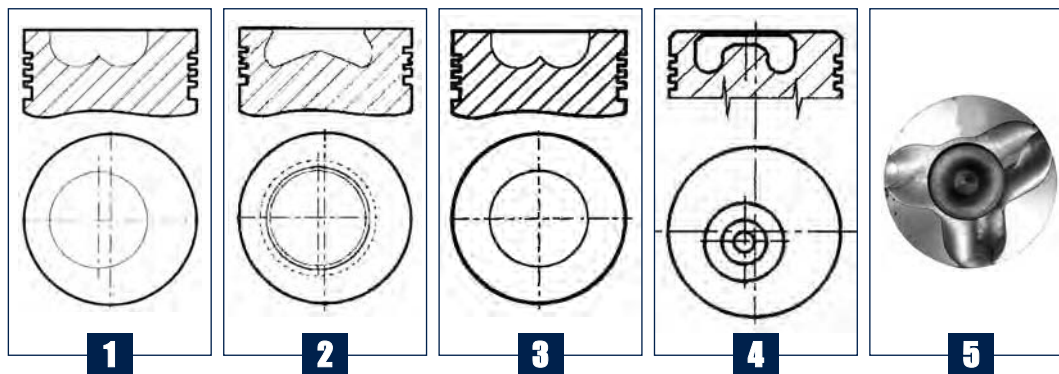
PISTONS
PISTONS

- A** : Hauteur de compres.
Compression height
B : Profond. ch. combust.
Combustion bowl depth
C : Hauteur totale
Overall length
D : Ø de l'axe de piston
Gudgeon pin diameter

Same - Lamborghini - Hürlimann

| Réf. Ref. | Moteurs Engines | Alésage Bore Ø | Type Type | Classe Classe | Segments Rings | Al-fin Al-fin | A mm | B mm | C mm | D mm |
|--------------|--|-------------------|--------------|------------------|-------------------|------------------|---------|---------|---------|---------|
| 32-90 | 1000.3W 1000.4W / WT 1000.6W / WT | 105.00 | - | - | - | - | - | - | - | - |
| 32-240 | 1000.4WT 1000.6WT | 105.00 | 1 | - | 3 | Y | 57.25 | 20.85 | 97.25 | 35.00 |
| 32-400 | 1000.4W | 105.00 | - | - | - | - | - | - | - | - |
| 32-401 | 1000.3W / WT 1000.4W / WT 1000.6WT | 105.00 | 2 | A | 3 | N | 57.15 | 19.40 | 97.35 | 35.00 |
| 32-402 | 1000.6WT | 105.00 | 2 | A | 3 | Y | 62.15 | 21.50 | 102.25 | 35.00 |
| 32-403 | 1000.3W / WT 1000.4W / WT 1000.6WT | 105.00 | 2 | B | 3 | N | 57.20 | 19.40 | 97.25 | 35.00 |
| 32-404 | 1000.6WT | 105.00 | 2 | B | 3 | Y | 62.15 | 21.50 | 102.25 | 35.00 |
| 32-405 | BF6M1013 | 108.00 | 3 | - | 3 | Y | 71.00 | 16.50 | 107.85 | 42.00 |
| 32-406 | BF6M1013 | 108.00 | 4 | - | 3 | Y | 71.00 | 19.95 | 107.95 | 42.00 |
| 32-407 | 1000.6WT | 105.00 | 3 | - | 3 | Y | 62.25 | 21.20 | 102.20 | 35.00 |
| 32-408 | 1000.3W / WT | 105.00 | 2 | A | 3 | Y | 57.15 | 21.50 | 97.25 | 35.00 |
| 32-409 | 1000.3W / WT | 105.00 | 2 | B | 3 | Y | 57.15 | 21.50 | 97.25 | 35.00 |
| 32-411 | 1000.4WT 1000.6WT | 105.00 | 2 | A | 3 | Y | 57.15 | 19.20 | 97.25 | 35.00 |
| 32-412 | 1000.4WT 1000.6WT | 105.00 | 2 | B | 3 | Y | 57.20 | 19.40 | 97.25 | 35.00 |
| 32-413 | 1000.3W / WT | 105.00 | 1 | A | 3 | Y | 57.30 | 20.85 | 97.25 | 35.00 |
| 32-414 | 916W1 916.6W2 | 103.00 | 1 | - | 3 | - | 60.00 | 20.60 | 100.00 | 32.00 |
| 32-415 | 916.6WT | 103.00 | 1 | - | 3 | Y | 60.05 | 22.10 | 100.00 | 35.00 |
| 32-417 | 1106/14T 1106/17T | 110.00 | 1 | - | 3 | Y | 74.00 | 26.00 | 130.00 | 40.00 |
| 32-418 | 1000.6 WT / WT1 | 105.00 | 5 | A | 3 | Y | 62.15 | 24.00 | 102.35 | 35.00 |
| 32-419 | 1000.6 WT / WT1 | 105.00 | 5 | B | 3 | Y | 62.25 | 24.00 | 102.35 | 35.00 |
| 32-420 | 1000.6WT | 105.00 | 5 | A | 3 | Y | 62.20 | 24.00 | 102.35 | 35.00 |











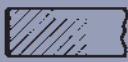
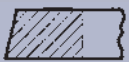

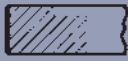
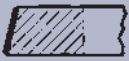
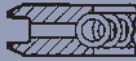
Les références des pièces sont indicatives.
Nos pièces ne sont pas d'origine

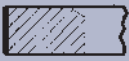
"THE RELIABLE SERVICE"

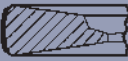
Part numbers are quoted for reference purposes only.
Our parts and accessories are not original.

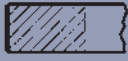
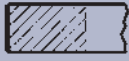
SEGMENTS RINGS

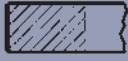
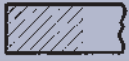
Same - Lamborghini - Hürlimann

| Réf. Ref. | Alésage Bore Ø | | | | | |
|--------------|-------------------|---|---|--|--|--|
| 34-400 | 105.00 |  CP2 3.00 |  T1 2.50 |  CBEH 4.00 | | |
| 34-401 | 105.00 |  CP2 3.00 |  CT1 2.50 |  CBEH 4.00 | | |
| 34-402 | 105.00 |  CK1 3.00 |  CP3 2.50 |  CBEH 4.00 | | |
| 34-405 | 108.00 |  CK2 2.80 |  CT5 2.00 |  CBEH 3.50 | | |
| 34-414 | 103.00 |  CP1 3.00 |  CP1 3.00 |  CBEH 4.00 | | |
| 34-417 | 110.00 |  CP1 2.95 |  P1 2.95 |  CBEH 6.00 | | |

CBEH : Chromé chanfreiné avec ressort hélicoïdal / *Chrome plated bevelled edge with helical coil spring*

CP1 : Rectangulaire chromé / *Chrome plated parallel faced*

CP2 : Rectangulaire chromé, épaulement intérieur en haut / *Chrome plated parallel faced internally stepped top*

CP3 : Rectangulaire chromé chanfrein intérieur en haut / *Chrome plated parallel faced internally bevelled top*

CK1 : Trapézoïdal bilatéral chromé / *Chrome plated keystone*

CK2 : Trapézoïdal bilatéral chromé / *Chrome plated keystone ID step*

CT1 : Portée conique chromé / *Chrome plated taper faced*

CT5 : Portée conique chromé épaulement intérieur en bas / *Chrome plated taper faced internally bevelled bottom*

P1 : Rectangulaire / *Parallel faced plain*

T1 : Portée conique / *Taper faced plain*

**CHEMISES
LINERS**

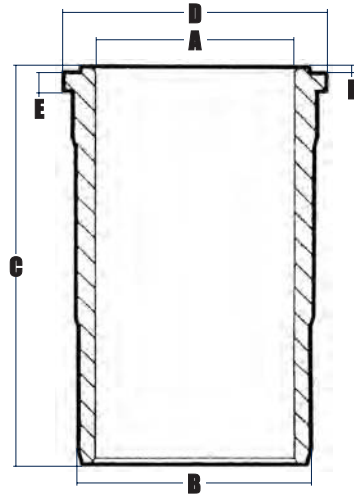

- A** : Alésage (mm)
Nominal bore diameter (mm)
- B** : Diamètre extérieur (mm)
Outside diameter (mm)
- C** : Hauteur totale (mm)
Overall length (mm)
- D** : Diamètre colerette (mm)
Flange diameter (mm)
- E** : Hauteur colerette (mm)
Flange width (mm)
- F** : Hauteur lèvre de feu (mm)
Fire lip height (mm)

Same - Lamborghini - Hürlimann

| Réf. Ref. | A mm | B mm | C mm | D mm | E mm | F mm |
|--------------|---------|---------|---------|---------|---------|---------|
| 35-400 | 105.00 | 112.00 | 195.00 | 123.00 | 7.00 | 1.00 |
| 35-401 | 105.00 | 112.00 | 195.00 | 123.00 | 7.00 | 1.00 |
| 35-402 | 105.00 | - | - | - | - | - |
| 35-403 | 105.00 | 112.80 | 193.00 | 123.00 | 7.00 | 1.00 |
| 35-405 | 108.00 | 117.55 | 228.00 | 128.40 | 9.00 | 1.15 |
| 35-406 | 108.00 | 117.65 | 228.00 | 128.40 | 9.00 | 1.15 |
| 35-414 | 103.00 | 111.90 | 195.00 | 122.95 | 7.00 | 0.90 |
| 35-415 | 103.00 | 111.90 | 195.00 | 122.95 | 7.00 | 0.95 |
| 35-416 | 103.00 | - | - | - | - | - |
| 35-417 | 110.00 | 127.95 | 227.00 | 140.00 | 10.10 | 0.95 |

JOINTS DE MOTEUR ENGINE GASKET SETS

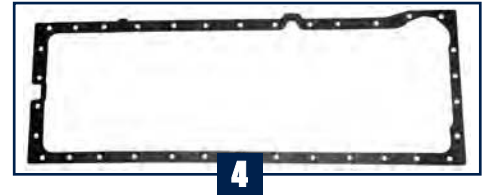
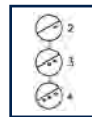
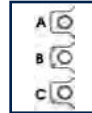
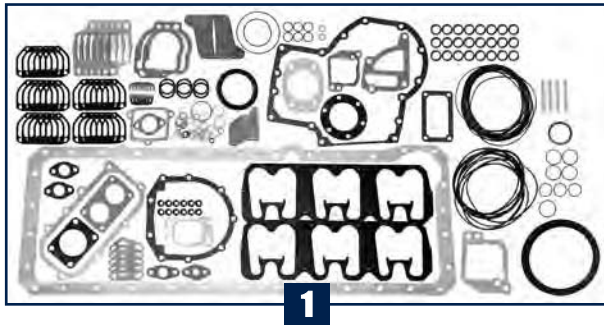

Same

| Tracteurs Tractors | Type Type | Pochette complete Full gasket set | Joint de culasse Cylinder head gasket | Joint cache soupapes Rocker cover gasket | Joint de carter Sump gasket |
|---|--------------|--|---|---|--|
| | | 1 | 2 | 3 | 4 |
| Moteurs 4 cylindres / 4 cylinder engines | | | | | |
| Row Crop 100 | 1000.4WT | 29/69-400 (0.335.0050.6, 0.335.0050.6/10) | 29/73-400 (A) (0.078.1451.0/40) 29/73-401 (B) (0.078.1452.0/30) 29/73-402 (C) (0.078.1453.0/40) | 29/74-48 (0.065.1450.0/30) | 29/75-400 (0.065.1550.0/10 0.065.1550.0/30) |
| Moteurs 6 cylindres / 6 cylinder engines | | | | | |
| Diamond 230, 260 Diamond II 230, 260 | BF6M1013 | 29/69-408 (02931279) | 29/73-408 (2) (04203968 04201559) 29/73-409 (3) (04201560) 29/73-410 (4) (04201561) | 29/74-408 (04205894) | 29/75-408 (04201000) |
| Rubin 120, 130, 150, 160 Rubin 160 Galileo Silver 110, 130 Titan 150, 160, 190 | 1000.6WT | 29/69-402 (0.337.0050.6, 0.337.0050.6/10) | 29/73-400 (A) (0.078.1451.0/40) | 29/74-402 (0.009.3877.0/10) | 29/75-402 (0.007.0849.0/10) |
| Rubin 180, 200 Rubin 180, 200, Galileo Titan 165, 190 Supertitan | 1000.6WTI | | 29/73-401 (B) (0.078.1452.0/30) | | |
| Silver 160, 180 | 1000.6WT | | 29/73-402 (C) (0.078.1453.0/40) | | |

Les références des pièces sont indicatives.
Nos pièces ne sont pas d'origine

"THE RELIABLE SERVICE"

Part numbers are quoted for reference purposes only.
Our parts and accessories are not original.

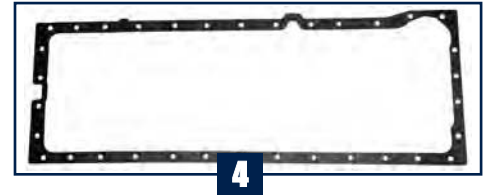
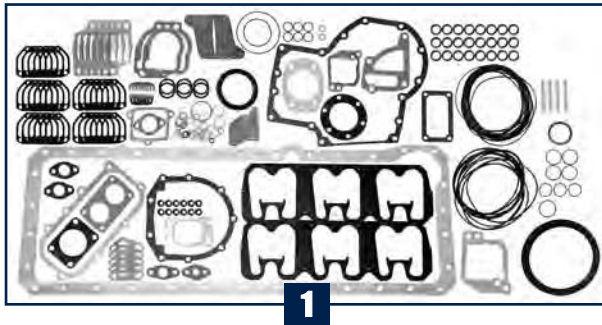
JOINTS DE MOTEUR
ENGINE GASKET SETS

Lamborghini

| Tracteurs Tractors | Type Type | Pochette complete Full gasket set | Joint de culasse Cylinder head gasket | Joint cache soupapes Rocker cover gasket | Joint de carter Sump gasket |
|--|--------------|--|---|--|--|
| | | 1 | 2 | 3 | 4 |
| Moteurs 3 cylindres / 3 cylinder engines | | | | | |
| Agile 660-s F Plus 775 Sprint 654-55, 664-60, 664-65 | 1000.3W | 32/69-403 (0.070.0050.6, 0.070.0050.6/10) | 32/73-400 (A) (0.078.1451.0/40) | 32/74-49 (0.069.1450.0/30) | 32/75-403 (0.007.0614.0/10) |
| Agile 770-s | 1000.3WT | | 32/73-401 (B) (0.078.1452.0/30) | | |
| Moteurs 4 cylindres / 4 cylinder engines | | | | | |
| 674-70 N, 774-80 N Agile 880-s Cross 674-70 N Ergomatic 674-70, 774-80 F Plus 880 Grand Prix 674-70, 774-80 Sprint 674-70, 674-75 Triumph 80, 90, 100 | 1000.4W | 32/69-404 (0.089.0050.6, 0.089.0050.6/10) | 32/73-400 (A) (0.078.1451.0/40) | 32/74-48 (0.065.1450.0/30, 0.009.3878.0/10) | 29/75-400 (0.065.1550.0/10 0.065.1550.0/30) |
| Agile 990-s Ergomatic 874-90 T F Plus 990 Grand Prix 874-90 T High Clearance 90 Sprint 684-85 | 1000.4WT | | | | |
| Premium 850, 950, 1050 | | 32/69-405 (0.090.0050.6, 0.090.0050.6/10) | 32/73-402 (C) (0.078.1453.0/40) | | |
| | | 32/69-400 (0.335.0050.6, 0.335.0050.6/10) | | | |
| Moteurs 6 cylindres / 6 cylinder engines | | | | | |
| 956-100 | 916W1 | 32/69-406 (0.075.0050.6, 0.075.0050.6/10) | 32/73-400 (A) (0.078.1451.0/40) | 32/74-402 (0.009.3877.0/10) | 32/75-406 (0.075.1512.0) |
| 1106 | 916.6W2 | | | | |
| 1306 | 916.6WT | 32/69-407 (0.078.0050.6, 0.078.0050.6/10) | 32/73-402 (C) (0.078.1453.0/40) | | |
| 1506 | 1106/14T | 32/70-419 (0.064.0050.6) | 32/73-419 (0.057.1456.0/30) | 32/74-419 (0.057.1457.0/20) | 32/75-419 (0.037.1512.0) |
| 1706 | 1106/17T | | | | |

Les références des pièces sont indicatives.
Nos pièces ne sont pas d'origine

"THE RELIABLE SERVICE"

Part numbers are quoted for reference purposes only.
Our parts and accessories are not original.

JOINTS DE MOTEUR ENGINE GASKET SETS

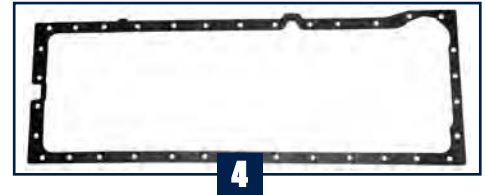
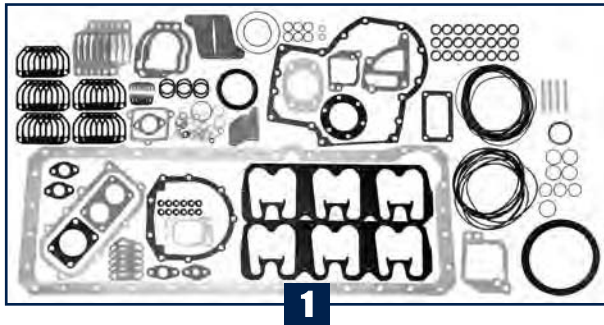

Lamborghini

| Tracteurs Tractors | Type Type | Pochette complete Full gasket set | Joint de culasse Cylinder head gasket | Joint cache soupapes Rocker cover gasket | Joint de carter Sump gasket | |
|--|--------------|---|---|---|--------------------------------|--------------------------------|
| | | 1 | 2 | 3 | 4 | |
| Moteurs 6 cylindres / 6 cylinder engines | | | | | | |
| Champion 120, 135, 160, 180, 200 Champion Intel Cab 160, 180, 200 | 1000.6WT | 32/69-402 (0.337.0050.6, 0.337.0050.6/10) | 32/73-400 (A) (0.078.1451.0/40) | 32/74-401 (0.010.9065.0) | 32/75-402 (0.007.0849.0/10) | |
| Champion 150 | 1000.6WTI | | | 32/73-401 (B) (0.078.1452.0/30) | | 32/74-402 (0.009.3877.0/10) |
| Formula 115 | 1000.6W | | | 32/73-402 (C) (0.078.1453.0/40) | | |
| Formula 135 Premium 1100, 1300 Racing 150, 165, 190 Racing Hi. Per. | 1000.6WT | | | | | |
| Premium 1600, 1800 | 1000.6WT | | | | | |
| Premium 1060 | 1000.6W | 32/69-402 (0.337.0050.6, 0.337.0050.6/10) | | 32/74-49 (0.069.1450.0/30) | | |
| Victory 230, 260 Victory Plus 230, 260 | BF6M1013 | 32/69-408 (02931279) | 32/73-408 (2) (04203968 04201559) 32/73-409 (3) (04201560) 32/73-410 (4) (04201561) | 32/74-408 (04205894) | 32/75-408 (04201000) | |

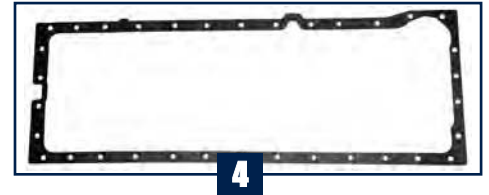
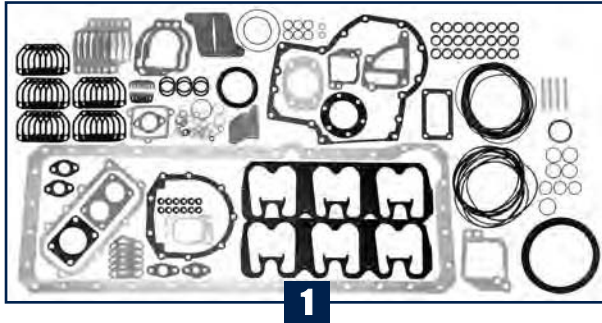
**JOINTS DE MOTEUR
ENGINE GASKET SETS**

Hürlimann

| Tracteurs Tractors | Type Type | Pochette complete Full gasket set | Joint de culasse Cylinder head gasket | Joint cache soupapes Rocker cover gasket | Joint de carter Sump gasket | |
|---|--------------|--|---|--|--|---|
| | | 1 | 2 | 3 | 4 | |
| Moteurs 3 cylindres / 3 cylinder engines | | | | | | |
| Prestige H-358 | 1000.3W | 33/69-403 (0.070.0050.6, 0.070.0050.6/10) | 33/73-400 (A) (0.078.1451.0/40) | 33/74-49 (0.069.1450.0/30) | 33/75-403 (0.007.0614.0/10) | |
| XA-606, 655 XN-706 | 1000.3W | | 33/73-401 (B) (0.078.1452.0/30) | | | |
| H-476-XF XA-656T XN-707 | 1000.3WT | | 33/73-402 (C) (0.078.1453.0/40) | | | |
| Moteurs 4 cylindres / 4 cylinder engines | | | | | | |
| Club H468-4 H-478-4 H-481-XF Prestige H-468, 478 XA-607, 657 XN-708 | 1000.4W | 33/69-404 (0.089.0050.6, 0.089.0050.6/10) | 33/73-400 (A) (0.078.1451.0/40) | 33/74-48 (0.065.1450.0/30, 0.009.3878.0/10) | 29/75-400 (0.065.1550.0/10 0.065.1550.0/30) | |
| H-491-XF Prestige H-488T XA-658 XN-709 | 1000.4WT | 33/69-405 (0.090.0050.6, 0.090.0050.6/10) | | | | 33/73-401 (B) (0.078.1452.0/30) |
| XT-908, 909, 910.4 | | 33/69-405 (0.090.0050.6, 0.090.0050.6/10) 33/69-400 (0.335.0050.6, 0.335.0050.6/10) | | | | 33/73-402 (C) (0.078.1453.0/40) |
| Moteurs 6 cylindres / 6 cylinder engines | | | | | | |
| Elite 6115-XB | 1000.6W | 33/69-402 (0.337.0050.6, 0.337.0050.6/10) | 33/73-400 (A) (0.078.1451.0/40) | 33/74-402 (0.009.3877.0/10) | 33/75-402 (0.007.0849.0/10) | |
| Elite 6135-XB Master H-6165, 6190, H.P. SX-1200, 1350, 1500, 1600, 1800, 2000 XT-911, 913 | 1000.6WT | | 33/73-401 (B) (0.078.1452.0/30) | | | |
| XT-910.6 | 1000.6WT | | 33/73-402 (C) (0.078.1453.0/40) | 33/74-49 (0.069.1450.0/30) | | |

Les références des pièces sont indicatives.
Nos pièces ne sont pas d'origine

"THE RELIABLE SERVICE"

Part numbers are quoted for reference purposes only.
Our parts and accessories are not original.

SOUPAPES ET PIÈCES CONNEXES CYLINDER HEAD PARTS



Same

| Tracteurs Tractors | Type Type | Guide Guide | Soup. admis. Inlet valve | Soup. échap. Outlet valve | Ressort Spring | Clavettes Cotter | Joint Seal |
|--|--------------|--------------------------------|---|---|-----------------------------|-----------------------------|-----------------------------|
| | | 1 | 2 | 3 | 4 | 5 | 6 |
| Moteurs 4 cylindres / 4 cylinder engines | | | | | | | |
| Row Crop 100 | 1000.4WT | 29/41-400 (0.007.1779.0/10) | 29/42-400 (0.010.6017.0) | 29/43-400 (0.010.6022.0) | 29/44-400 (2.4019.287.0) | 29/46-400 (0.074.1423.0) | 29/47-400 (2.1519.117.0) |
| Moteurs 6 cylindres / 6 cylinder engines | | | | | | | |
| Diamond 230, 260 Diamond II 230, 260 | BF6M1013 | 29/41-405 (04201238) | 29/42-405 (04283380 04209110 04255254 04255883) | 29/43-405 (04283381 04209111 04255255) | 29/44-405 (04200150) | 29/46-405 (12164698) | 29/47-405 (01153857) |
| Rubin 135 Silver 130 | 1000.6WT | 29/41-400 (0.007.1779.0/10) | 29/42-400 (0.010.6017.0) | 29/43-400 (0.010.6022.0) | 29/44-400 (2.4019.287.0) | 29/46-400 (0.074.1423.0) | 29/47-400 (2.1519.117.0) |
| Silver 110 | 1000.6WT | | 29/42-28 (0.010.6016.0) | 29/43-402 (0.066.1421.0) | | | |
| Rubin 120, 150, 160 Rubin 160 Galileo Silver 130, 160, 180 Titan 150 (⇒ 3001) Titan 160, 190 | 1000.6WT | | 29/42-401 (0.007.1146.0/10) | 29/43-401 (0.007.1147.0/10) | | | |
| Rubin 180, 200 Rubin 180, 200 Galileo Titan 165, 190 (⇒ 3001) Supertitan | 1000.6WTI | | | | | | |

SOUPAPES ET PIÈCES CONNEXES
CYLINDER HEAD PARTS



Lamborghini

| Tracteurs Tractors | Type Type | Guide Guide | Soup. admis. Inlet valve | Soup. échap. Outlet valve | Ressort Spring | Clavettes Cotter | Joint Seal |
|---|--------------|--------------------------------|---------------------------------|---------------------------------|-----------------------------|-----------------------------|-----------------------------|
| | | 1 | 2 | 3 | 4 | 5 | 6 |
| Moteurs 3 cylindres / 3 cylinder engines | | | | | | | |
| Agile 660-s Sprint 654-55, 664-60, 664-65 | 1000.3W | 32/41-400 (0.007.1779.0/10) | 32/42-28 (0.010.6016.0) | 32/43-402 (0.066.1421.0) | 32/44-400 (2.4019.287.0) | 32/46-400 (0.074.1423.0) | 32/47-400 (2.1519.117.0) |
| F Plus 775 | 1000.3W | | 32/42-418 (A) (0.081.1420.0) | 32/43-402 (A) (0.066.1421.0) | | | |
| | | | 32/42-400 (B) (0.010.6017.0) | 32/43-400 (B) (0.010.6022.0) | | | |
| Agile 770-s | 1000.3WT | | 32/42-400 (0.010.6017.0) | 32/43-400 (0.010.6022.0) | | | |
| Moteurs 4 cylindres / 4 cylinder engines | | | | | | | |
| 674-70 N, 774-80 N Agile 880-s Cross 674-70 N Ergomatic 674-70, 774-80 F Plus 880 Grand Prix 674-70, 774-80 Sprint 674-70, 674-75 Triumph 80 | 1000.4W | 32/41-400 (0.007.1779.0/10) | 32/42-28 (0.010.6016.0) | 32/43-402 (0.066.1421.0) | 32/44-400 (2.4019.287.0) | 32/46-400 (0.074.1423.0) | 32/47-400 (2.1519.117.0) |
| Premium 850 Sprint 684-85 | 1000.4WT | | | | | | |
| Agile 990-s High Clearance 90 | 1000.4WT | | 32/42-400 (0.010.6017.0) | 32/43-400 (0.010.6022.0) | | | |
| Triumph 90, 100 | 1000.4W | | | | | | |
| Ergomatic 874-90 T F Plus 990 Grand Prix 874-90 T Premium 950, 1050 | 1000.4WT | | 32/42-418 (A) (0.081.1420.0) | 32/43-402 (A) (0.066.1421.0) | | | |
| | | | 32/42-400 (B) (0.010.6017.0) | 32/43-400 (B) (0.010.6022.0) | | | |

Les références des pièces sont indicatives.
Nos pièces ne sont pas d'origine

"THE RELIABLE SERVICE"

Part numbers are quoted for reference purposes only.
Our parts and accessories are not original.

SOUPAPES ET PIÈCES CONNEXES CYLINDER HEAD PARTS



Lamborghini

| Tracteurs Tractors | Type Type | Guide Guide | Soup. admis. Inlet valve | Soup. échap. Outlet valve | Ressort Spring | Clavettes Cotter | Joint Seal |
|--|--------------|---------------------------------|---|---|---|--------------------------------|-----------------------------|
| | | 1 | 2 | 3 | 4 | 5 | 6 |
| Moteurs 6 cylindres / 6 cylinder engines | | | | | | | |
| 956-100 | 916W1 | 32/41-400 (0.007.1779.0/10) | 32/42-28 (0.010.6016.0) | 32/43-402 (0.066.1421.0) | 32/44-400 (2.4019.287.0) | 32/46-400 (0.074.1423.0) | 32/47-400 (2.1519.117.0) |
| 1106 | 916.6W2 | | 32/42-418 (A) (0.081.1420.0) | 32/43-402 (A) (0.066.1421.0) | | | |
| 1306 | 916.6WT | 32/42-400 (B) (0.010.6017.0) | 32/43-400 (B) (0.010.6022.0) | | | | |
| 1506 | 1106/14T | 32/41-419 (0.057.1416.0) | 32/42-419 (0.009.7266.0) | 32/43-419 (0.009.7267.2) | 32/44-419 (2.4019.228.0) | 32/46-419 (0.058.1423.0) | |
| Champion 120, 135, 160, 180, 200 Champion Intel Cab 160, 180, 200 | 1000.6WT | 32/41-403 (0.007.1505.0/20) | 32/42-403 (0.007.1509.0/10) | 32/43-403 (0.007.1508.0) | 32/44-403 (2.4019.484.0 + 2.4019.485.0) | 32/46-403 (0.007.1507.0/10) | |
| Champion 150 | 1000.6WTI | | | | | | |
| Formula 115 Premium 1060 | 1000.6W | 32/41-400 (0.007.1779.0/10) | 32/42-28 (0.010.6016.0) | 32/43-402 (0.066.1421.0) | 32/44-400 (2.4019.287.0) | 32/46-400 (0.074.1423.0) | 32/47-400 (2.1519.117.0) |
| Formula 135 | 1000.6WT | | 32/42-418 (A) (0.081.1420.0) | 32/43-402 (A) (0.066.1421.0) | | | |
| Premium 1300 | 1000.6WT | | 32/42-400 (B) (0.010.6017.0) | 32/43-400 (B) (0.010.6022.0) | | | |
| Premium 1600, 1800 Racing 150, 165, 190 Racing Hi. Per. | 1000.6WT | | 32/42-401 (0.007.1146.0/10) | 32/43-401 (0.007.1147.0/10) | | | |
| Victory 230, 260 Victory Plus 230, 260 | BF6M1013 | 29/41-405 (04201238) | 29/42-405 (04283380 04209110 04255254 04255883) | 29/43-405 (04283381 04209111 04255255) | 29/44-405 (04200150) | 29/46-405 (12164698) | 29/47-405 (01153857) |

Les références des pièces sont indicatives.
Nos pièces ne sont pas d'origine

"THE RELIABLE SERVICE"

Part numbers are quoted for reference purposes only.
Our parts and accessories are not original.

SOUPAPES ET PIÈCES CONNEXES
CYLINDER HEAD PARTS



Hürlimann

| Tracteurs Tractors | Type Type | Guide Guide | Soup. admis. Inlet valve | Soup. échap. Outlet valve | Ressort Spring | Clavettes Cotter | Joint Seal |
|---|--------------|--------------------------------|---------------------------------|---------------------------------|-----------------------------|-----------------------------|-----------------------------|
| | | 1 | 2 | 3 | 4 | 5 | 6 |
| Moteurs 3 cylindres / 3 cylinder engines | | | | | | | |
| Prestige H-358 XA-606, 655 XN-706 | 1000.3W | 33/41-400 (0.007.1779.0/10) | 33/42-28 (0.010.6016.0) | 33/43-402 (0.066.1421.0) | 33/44-400 (2.4019.287.0) | 33/46-400 (0.074.1423.0) | 33/47-400 (2.1519.117.0) |
| XA-656T | 1000.3WT | | 33/42-418 (A) (0.081.1420.0) | 33/43-402 (A) (0.066.1421.0) | | | |
| H-476-XF | 1000.3WT | | 33/42-400 (B) (0.010.6017.0) | 33/43-400 (B) (0.010.6022.0) | | | |
| XN-707 | 1000.3WT | | 33/42-400 (0.010.6017.0) | 33/43-400 (0.010.6022.0) | | | |
| Moteurs 4 cylindres / 4 cylinder engines | | | | | | | |
| Club H-468-4 H-478-4 H-481-XF Prestige H-468, 478 XA-607, 657 XN-708 | 1000.4W | 33/41-400 (0.007.1779.0/10) | 33/42-28 (0.010.6016.0) | 33/43-402 (0.066.1421.0) | 33/44-400 (2.4019.287.0) | 33/46-400 (0.074.1423.0) | 33/47-400 (2.1519.117.0) |
| XA-658 XT-908 | 1000.4WT | | 33/42-418 (A) (0.081.1420.0) | 33/43-402 (A) (0.066.1421.0) | | | |
| Prestige H-488T H-491-XF XT-909, 910.4 | 1000.4WT | | 33/42-400 (B) (0.010.6017.0) | 33/43-400 (B) (0.010.6022.0) | | | |
| XN-709 | 1000.4WT | | 33/42-400 (0.010.6017.0) | 33/43-400 (0.010.6022.0) | | | |



SOUPAPES ET PIÈCES CONNEXES CYLINDER HEAD PARTS



Hürlimann

| Tracteurs Tractors | Type Type | Guide Guide | Soup. admis. Inlet valve | Soup. échap. Outlet valve | Ressort Spring | Clavettes Cotter | Joint Seal |
|--|--------------|--------------------------------|---------------------------------|---------------------------------|-----------------------------|-----------------------------|-----------------------------|
| | | 1 | 2 | 3 | 4 | 5 | 6 |
| Moteurs 6 cylindres / 6 cylinder engines | | | | | | | |
| Elite 6115-XB | 1000.6W | 33/41-400 (0.007.1779.0/10) | 33/42-28 (0.010.6016.0) | 33/43-402 (0.066.1421.0) | 33/44-400 (2.4019.287.0) | 33/46-400 (0.074.1423.0) | 33/47-400 (2.1519.117.0) |
| SX-1200 XT-910.6, 911 | 1000.6WT | | | | | | |
| Master H-6165, 6190 Master H.P. SX-1500, 1600, 1800, 2000 | 1000.6WT | | | | | | |
| Elite 6135-XB | 1000.6WT | | 33/42-418 (A) (0.081.1420.0) | 33/43-402 (A) (0.066.1421.0) | | | |
| | | | 33/42-400 (B) (0.010.6017.0) | 33/43-400 (B) (0.010.6022.0) | | | |
| SX-1350 XT-913 | 1000.6WT | | 33/42-400 (0.010.6017.0) | 33/43-400 (0.010.6022.0) | | | |

POMPES A EAU
WATER PUMPS
Same

| Tracteurs <i>Tractors</i> | Type <i>Type</i> | Illustration <i>Illustration</i> | Réf. <i>Ref.</i> | OEM <i>OEM</i> |
|--|----------------------------|--|----------------------------|--------------------------|
| Diamond 230, 260 Diamond II 230, 260 | BF6M1013 |  | 29/130-101 | 04205959, 04256853 |
| Rubin 120, 135, 150, 160 Rubin 160 Galileo Silver 110, 130, 160, 180 Titan 150 (⇒ 3001) Titan 160, 190 | 1000.6 WT |  | 29/130-39 | 0.010.1138.4/30 |
| Rubin 180, 200 Rubin 180, 200 Galileo Titan 165, 190 (⇒ 3001) SuperTitan | 1000.6 WTI | | | |

FILTRATION FILTERS



1



2



3

Same

| Tracteurs Tractors | Type Type | Air | | Huile Oil | Combustible Fuel | Hydraulique Hydraulic |
|--|------------------------|------------------------------|------------------------------|----------------------------|-----------------------------|--|
| | | Ext. Out. | Int. Inn. | | | |
| | | 1 | 2 | 3 | | |
| Diamond 230, 260 Diamond II 230, 2606 | BF6M1013 | 60/161-53 | 60/162-53 | 60/97-39 (01174421) | 60/111-56 (01180597) | 60/240-52 (04417454) |
| Row Crop 100 | 1000.4 WT | 60/161-104 (2.4249.310.4) | 60/162-25 (2.4249.130.7) | | | 60/240-69 (2.4419.350.0) 60/240-67 (2.4419.320.0/10) 60/641-32 (2.4419.640.0) 60/240-67 (2.4419.320.0/10) 60/240-153 (2.4419.670.0/20) 60/240-154 (2.4419.730.0) 60/240-155 (2.4419.450.0) 60/652-1 (0.9012.428.2) 60/240-150 (2.4419.491.0) 60/240-153 (2.4419.670.0/20) 60/240-154 (2.4419.730.0) 60/240-155 (2.4419.450.0) 60/652-1 (0.9012.428.2) 60/240-150 (2.4419.491.0) |
| Rubin 120, 135, 150 | 1000.6 WT | 60/161-131 (0.010.2183.0) | 60/162-93 (2.4249.380.2) | 60/97-22 (2.4419.340.0) | 60/111-25 (0.009.4687.0) | |
| Rubin 160 Rubin 180, 200 | 1000.6 WT 1000.6WTI | 60/161-135 (0.010.2800.1) | 60/162-135 (0.010.2800.2) | | | |

**FILTRATION
 FILTERS**
Same

| Tracteurs Tractors | Type Type | Air | | Huile Oil | Combustible Fuel | Hudraulique Hydraulic |
|---|-------------------------|---|-------------------------------------|-----------------------------------|------------------------------------|--|
| | | Ext. Out. | Int. Inn. | | | |
| | | 1 | 2 | 3 | 4 | 5 |
| Rubin 160 Galileo Rubin 180, 200 Galileo | 1000.6 WT 1000.6 WTI | 60/161-135 (0.010.2800.1) | 60/162-135 (0.010.2800.2) | | | 60/240-153 (2.4419.670.0/20) 60/240-154 (2.4419.730.0) 60/240-155 (2.4419.450.0) 60/652-1 (0.9012.428.2) 60/240-150 (2.4419.491.0) 60/240-156 (0.010.8872.0/10) 60/641-32 (2.4419.640.0) |
| Silver 110, 130 | 1000.6 WT | 60/161-131 (0.010.2183.0) 60/161-93 (0.009.4144.1) | 60/162-93 (2.4249.380.2) | 60/97-22 (2.4419.340.0) | 60/111-25 (0.009.4687.0) | 60/240-155 (2.4419.450.0) 60/652-1 (0.9012.428.2) 60/240-150 (2.4419.491.0) 60/240-66 (2.4419.280.0) |
| Silver 110, 130 (⇒ 3001) | 1000.6 WT | | | | | 60/240-155 (2.4419.450.0) 60/240-150 (2.4419.491.0) 60/240-153 (2.4419.670.0/20) |
| Silver 160, 180 | 1000.6 WT | 60/161-77 (0.009.4876.0) | 60/162-77 (0.009.4270.1) | | 60/111-4 (2.4319.130.1) | 60/641-32 (2.4419.640.0) 60/240-67 (2.4419.320.0/10) 60/240-155 (2.4419.450.0) 60/240-150 (2.4419.491.0) |

FILTRATION FILTERS

Same

| Tracteurs Tractors | Type Type | Air | | Huile Oil | Combustible Fuel | Hudraulique Hydraulic |
|---|---------------------------------------|--|------------------------------------|-----------------------------------|-----------------------------------|---|
| | | Ext. Out. | Int. Inn. | | | |
| | | 1 | 2 | 3 | 4 | 5 |
| Titan 160, 190 | 1000.6 WT | 60/161-77 (0.009.4876.0) 60/161-132 (0.009.4270.0) 60/161-133 (0.009.4340.0) | | | | 60/240-155 (2.4419.450.0) 60/652-1 (0.9012.428.2) 60/240-150 (2.4419.491.0) 60/240-67 (2.4419.320.0/10) 60/240-69 (2.4419.350.0) |
| Titan 150 (⇒ 3001) Titan 165, 109 (⇒ 3001) SuperTitan | 1000.6 WT 1000.6 WTI 1000.6 WTI | 60/161-77 (0.009.4876.0) | 60/162-77 (0.009.4270.1) | 60/97-22 (2.4419.340.0) | 60/111-4 (2.4319.130.1) | 60/641-32 (2.4419.640.0) 60/240-155 (2.4419.450.0) 60/652-1 (0.9012.428.2) 60/240-150 (2.4419.491.0) 60/574-7 M (2.4419.611.0) 60/240-67 (2.4419.320.0/10) |

**FILTRATION
 FILTERS**
Lamborghini

| Tracteurs Tractors | Type Type | Air | | Huile Oil | Combustible Fuel | Hudraulique Hydraulic |
|---|-----------------------------------|---|---|-----------------------------------|------------------------------------|--|
| | | Ext. Out. | Int. Inn. | | | |
| | | 1 | 2 | 3 | 4 | 5 |
| 674-70 N (⇒ 12000) | 1000.4 W | 60/161-112 (2.4249.410.7 2.4249.340.1) | 60/162-112 (2.4249.410.5 2.4249.340.2) | 60/97-36 (0.044.1567.0) | 60/111-3 (2.4319.060.1) | 60/240-69 (2.4419.350.0) |
| 774-80 N (⇒ 12000) | 1000.4 W | 60/161-104 (2.4249.310.4) | 60/162-25 (2.4249.130.7) | | | |
| 956-100 | 916 W1 | | | | | |
| 1106 | 916.6 W2 | | | | | |
| 1306 | 916.6 WT | | | | | |
| 1506 | 1106/14 T | 60/161-166 (2.4249.380.1) | 60/162-93 (2.4249.380.2) | 60/97-21 (0.052.1565.0) | 60/111-4 (2.4319.130.1) | 60/240-158 (0.264.6360.2) |
| 1706 | 1106/17 T | 60/161-64 (2.4249.280.3) | 60/162-64 (2.4249.280.1) | | | |
| Agile 660-s Agile 770-s Agile 880-s | 1000.3 W 1000.3 WT 1000.4 W | 60/161-104 (2.4249.131.0) | 60/162-25 (2.4249.130.7) | 60/97-36 (0.044.1567.0) | 60/111-3 (2.4319.060.1) | 60/574-7 M (2.4419.611.0) |
| Agile 990-s | 1000.4 WT | | | | | 60/161-104 (2.4249.131.0) |
| | | 60/240-41 (2.4419.721.0) | | | | |
| | | 60/641-32 (2.4419.640.0) | | | | |
| Champion 120, 135 Champion 150 | 1000.6 WT 1000.6 WTI | 60/161-131 (0.010.2183.0) | 60/162-93 (2.4249.380.2) | 60/97-22 (2.4419.340.0) | 60/111-25 (0.009.4687.0) | 60/652-1 (0.9012.428.2) |
| | | | | | | 60/240-157 (2.4419.680.0/10) |
| | | | | | | 60/240-155 (2.4419.450.0) |
| | | | | | | 60/240-67 (2.4419.320.0/10) |
| | | | | | | 60/641-32 (2.4419.640.0) |
| 60/240-150 (2.4419.491.0) | | | | | | |
| 60/240-153 (2.4419.670.0/20) | | | | | | |
| 60/240-154 (2.4419.730.0) | | | | | | |
| 60/652-1 (0.9012.428.2) | | | | | | |

FILTRATION FILTERS

Lamborghini

| Tracteurs Tractors | Type Type | Air | | Huile Oil | Combustible Fuel | Hydraulique Hydraulic |
|--|-----------------------------------|--|--|----------------------------|-----------------------------|---------------------------------|
| | | Ext. Out. | Int. Inn. | | | |
| | | 1 | 2 | 3 | 4 | 5 |
| Champion 160, 180, 200 | 1000.6 WT | 60/161-135 (0.010.2800.1) | 60/162-135 (0.010.2800.2) | 60/97-22 (2.4419.340.0) | 60/111-25 (0.009.4687.0) | 60/240-153 (2.4419.670.0/20) |
| | | | | | | 60/240-154 (2.4419.730.0) |
| Champion 160, 180, 200 Intel Cab | 1000.6 WT | | | | | 60/240-155 (2.4419.450.0) |
| | | | | | | 60/652-1 (0.9012.428.2) |
| | | | | | | 60/240-150 (2.4419.491.0) |
| | | | | | | 60/240-150 (2.4419.491) |
| | | | | | | 60/240-156 (0.010.8872.0/10) |
| Cross 674-70 N | 1000.4 W | 60/161-112 (2.4249.410.7 2.4249.340.1) | 60/162-112 (2.4249.410.5 2.4249.340.2) | | | 60/652-1 (0.9012.428.2) |
| | | | | | | 60/240-69 (2.4419.350.0) |
| C674, C774 R674, R774 | 916.4 W | | | 60/97-36 (0.044.1567.0) | | 60/240-159 (0.008.3100.0) |
| Ergomatic C 674-70, 774-80 Ergomatic C 874-90 | 1000.4 W 1000.4 WT | 60/161-104 (2.4249.310.4) | 60/162-25 (2.4249.130.7) | | | |
| F Plus 660 | 1000.3 W | 60/161-112 (2.4249.410.7 2.4249.340.1) | 60/162-112 (2.4249.410.5 2.4249.340.2) | | 60/111-3 (2.4319.060.1) | 60/240-155 (2.4419.450.0) |
| F Plus 775 F Plus 880 F Plus 990 | 1000.3 W 1000.4 W 1000.4 WT | 60/161-104 (2.4249.310.4) | | | | |
| F Plus 990 | 1000.4 WT | | | | 60/162-25 (2.4249.130.7) | 60/97-22 (2.4419.340.0) |
| Formula 115 (⇒ 3001) | 1000.6 W | 60/161-104 (0.009.4108.0 2.4249.131.0) | | 60/97-36 (0.044.1567.0) | 60/111-4 (2.4319.130.1) | 60/240-66 (2.4419.280.0) |
| | | 60/161-136 (0.010.2179.0) | | | | |
| Formula 135 (⇒ 3001) | 1000.6 WT | 60/161-131 (0.010.2183.0) | 60/162-93 (2.4249.380.2) | 60/97-22 (2.4419.340.0) | | 60/240-150 (2.4419.491.0) |
| | | 60/161-93 (0.009.4144.1) | | | | |
| | | | | | | 60/240-66 (2.4419.280.0) |

**FILTRATION
 FILTERS**
Lamborghini

| Tracteurs Tractors | Type Type | Air | | Huile Oil | Combustible Fuel | Hudraulique Hydraulic |
|------------------------|--------------|---|---|-----------------------------------|------------------------------------|--|
| | | Ext. Out. | Int. Inn. | | | |
| | | 1 | 2 | 3 | 4 | 5 |
| Grand Prix 674-70 | 1000.4 W | 60/161-112 (2.4249.410.7 2.4249.340.1) | 60/162-112 (2.4249.410.5 2.4249.340.2) | 60/97-36 (0.044.1567.0) | 60/111-3 (2.4319.060.1) | 60/240-155 (2.4419.450.0) 60/652-1 (0.9012.428.2) 60/240-69 (2.4419.350.0) |
| Grand Prix 774-80 | 1000.4 W | | | | | 60/240-155 (2.4419.450.0) 60/652-1 (0.9012.428.2) |
| Grand Prix 874-90T | 1000.4 WT | | | | | 60/240-69 (2.4419.350.0) 60/240-68 (2.4419.270.0) |
| Premium 850, 950, 1050 | 1000.4 WT | 60/161-104 (2.4249.310.4) | 60/162-25 (2.4249.130.7) | 60/97-22 (2.4419.340.0) | 60/111-25 (0.009.4687.0) | 60/240-155 (2.4419.450.0) 60/652-1 (0.9012.428.2) 60/240-69 (2.4419.350.0) 60/240-66 (2.4419.280.0) |
| Premium 1060 | 1000.6 W | | | 60/97-36 (0.044.1567.0) | | 60/240-156 (0.010.8872.0/10) 60/240-160 (2.4419.690.0) 60/240-161 (2.4419.750.0) |
| Premium 1100, 1300 | 1000.6 WT | | | | | 60/161-131 (0.010.2183.0) 60/161-93 (0.009.4144.1) |

FILTRATION FILTERS

Lamborghini

| Tracteurs Tractors | Type Type | Air | | Huile Oil | Combustible Fuel | Hudraulique Hydraulic |
|---|----------------------|--|---|-----------------------------------|------------------------------------|---|
| | | Ext. Out. | Int. Inn. | | | |
| | | 1 | 2 | 3 | 4 | 5 |
| Premium 1600, 1800 | 1000.6 WT | 60/161-77 (0.009.4876.0) | 60/162-77 (0.009.4270.1) | 60/97-22 (2.4419.340.0) | 60/111-4 (2.4319.130.1) | 60/641-32 (2.4419.640.0) |
| | | | | | | 60/240-155 (2.4419.450.0) |
| | | | | | | 60/652-1 (0.9012.428.2) |
| Racing 150, 165, 190 | 1000.6 WT | 60/161-77 (0.009.4876.0) 60/161-132 (0.009.4270.0) 60/161-133 (0.009.4340.0) | | | | 60/240-150 (2.4419.491.0) |
| | | | | | | 60/240-67 (2.4419.320.0/10) |
| | | | | | | 60/240-69 (2.4419.350.0) |
| Racing 150, 165, 190 (⇒ 3001) Racing Hi. Per. | 1000.6 WT | 60/161-77 (0.009.4876.0) | | | | 60/240-155 (2.4419.450.0) 60/652-1 (0.9012.428.2) 60/240-150 (2.4419.491.0) 60/574-7 M (2.4419.611.0) 60/641-32 (2.4419.640.0) 60/240-67 (2.4419.320.0/10) |
| Sprint 654-55, 664-65 Sprint 674-75 | 1000.3 W 1000.4 W | 60/161-104 (2.4249.131.0) | 60/162-25 (2.4249.130.7) | 60/97-36 (0.044.1567.0) | 60/111-25 (0.009.4687.0) | 60/652-1 (0.9012.428.2) |
| Sprint 684-85 | 1000.4 W | | | 60/97-22 (2.4419.340.0) | | 60/240-156 (0.010.8872.0/10) |
| Sprint 664-60 | 1000.3 W | 60/161-104 (2.4249.131.0) 60/161-143 (0.010.2095.0) | 60/162-25 (2.4249.130.7) 60/162-143 (0.010.2094.0) | 60/97-36 (0.044.1567.0) | | 60/240-66 (2.4419.280.0) 60/240-69 (2.4419.350.0) |
| Sprint 674-70 | 1000.4 W | 60/161-104 (2.4249.131.0) | 60/162-25 (2.4249.130.7) | | | 60/240-159 (0.008.3100.0) |

**FILTRATION
 FILTERS**
Lamborghini

| Tracteurs Tractors | Type Type | Air | | Huile Oil | Combustible Fuel | Hydraulique Hydraulic |
|---|--------------|------------------------------|-----------------------------|----------------------------|-----------------------------|--------------------------------|
| | | Ext. Out. | Int. Inn. | | | |
| | | 1 | 2 | 3 | 4 | 5 |
| Triumph 80 | 1000.4 W | 60/161-104 (2.4249.131.0) | 60/162-25 (2.4249.130.7) | 60/97-36 (0.044.1567.0) | 60/111-3 (2.4319.060.1) | 60/240-67 (2.4419.320.0/10) |
| Triumph 90, 100 | 1000.4 W | | | 60/97-22 (2.4419.340.0) | 60/111-25 (0.009.4687.0) | |
| Victory 230, 260 Victory Plus 230, 260 | BF6M1013 | 60/161-53 | 60/162-53 | 60/97-39 (01174421) | 60/111-56 (01180597) | 60/240-52 (04417454) |

Hürlimann

| Tracteurs Tractors | Type Type | Air | | Huile Oil | Combustible Fuel | Hydraulique Hydraulic |
|----------------------------------|------------------------------------|--|--|----------------------------|----------------------------|---------------------------------|
| | | Ext. Out. | Int. Inn. | | | |
| | | 1 | 2 | 3 | 4 | 5 |
| Club H-468-4 | 1000.4 W | 60/161-112 (2.4249.410.7 2.4249.340.1) | 60/162-112 (2.4249.410.5 2.4249.340.2) | 60/97-36 (0.044.1567.0) | 60/111-3 (2.4319.060.1) | 60/652-1 (0.9012.428.2) |
| | | | | | | |
| Elite 6115-XB | 1000.6 W | 60/161-104 (0.009.4108.0 2.4249.131.0) | 60/162-25 (2.4249.130.7) | 60/97-22 (2.4419.340.0) | 60/111-4 (2.4319.130.1) | 60/240-69 (2.4419.350.0) |
| | | 60/161-136 (0.010.2179.0) | | | | |
| Elite 6135-XB | 1000.6 WT | 60/161-131 (0.010.2183.0) | 60/162-93 (2.4249.380.2) | 60/97-36 (0.044.1567.0) | 60/111-3 (2.4319.060.1) | 60/652-1 (0.9012.428.2) |
| | | 60/161-93 (0.009.4144.1) | | | | |
| H-478-4 (⇒ 10500) | 1000.4 W | 60/161-104 (2.4249.310.4) | 60/162-25 (2.4249.130.7) | 60/97-36 (0.044.1567.0) | 60/111-3 (2.4319.060.1) | 60/240-150 (2.4419.491.0/10) |
| | | | | | | |
| H-476-XF H-481-XF H-491-XF | 1000.3 WT 1000.4 W 1000.4 WT | | | | | 60/240-69 (2.4419.350.0) |
| | | | | | | 60/240-155 (2.4419.450.0) |
| | | | | | | 60/240-67 (2.4419.320.0/10) |
| | | | | | | 60/652-1 (0.9012.428.2) |
| | | | | | | 60/240-66 (2.4419.280.0) |

FILTRATION FILTERS

Hürlimann

| Tracteurs Tractors | Type Type | Air | | Huile Oil | Combustible Fuel | Hydraulique Hydraulic |
|--|-----------------------|--|---|-----------------------------------|-----------------------------------|--|
| | | Ext. Out. | Int. Inn. | | | |
| | | 1 | 2 | 3 | 4 | 5 |
| Master H-6165, 6190 | 1000.6 WT | 60/161-77 (0.009.4876.0) 60/161-132 (0.009.4270.0) 60/161-133 (0.009.4340.0) | | | | 60/240-155 (2.4419.450.0) 60/240-67 (2.4419.320.0/10) 60/240-150 (2.4419.491.0/10) 60/652-1 (0.9012.428.2) 60/240-69 (2.4419.350.0) |
| Master H-6165, 6190 (⇒ 2001) Master H.P. | 1000.6 WT | 60/161-77 (0.009.4876.0) | 60/162-77 (0.009.4270.1) | 60/97-22 (2.4419.340.0) | 60/111-4 (2.4319.130.1) | 60/240-155 (2.4419.450.0) 60/240-67 (2.4419.320.0/10) 60/641-32 (2.4419.640.0) 60/240-150 (2.4419.491.0/10) 60/652-1 (0.9012.428.2) 60/574-7 M (2.4419.611.0) |
| Prestige H-358 Prestige H-468 | 1000.3 W 1000.4 W | 60/161-112 (2.4249.410.7 2.4249.340.1) | 60/162-112 (2.4249.410.5 2.4249.340.2) | | | 60/240-155 (2.4419.450.0) 60/652-1 (0.9012.428.2) 60/240-69 (2.4419.350.0) |
| Prestige H-478 Prestige H-488 T | 1000.4 W 1000.4 WT | 60/161-104 (2.4249.310.4) | 60/162-25 (2.4249.130.7) | 60/97-36 (0.044.1567.0) | 60/111-3 (2.4319.060.1) | 60/240-155 (2.4419.450.0) 60/652-1 (0.9012.428.2) 60/240-66 (2.4419.280.0) 60/240-69 (2.4419.350.0) 60/240-68 (2.4419.270.0) |

**FILTRATION
 FILTERS**
Hürlimann

| Tracteurs Tractors | Type Type | Air | | Huile Oil | Combustible Fuel | Hudraulique Hydraulic |
|-----------------------------------|------------------------------------|-------------------------------------|-------------------------------------|-----------------------------------|------------------------------------|--|
| | | Ext. Out. | Int. Inn. | | | |
| | | 1 | 2 | 3 | 4 | 5 |
| SX-1200, 1350, 1500 | 1000.6 WT | 60/161-131 (0.010.2183.0) | 60/162-93 (2.4249.380.2) | 60/97-22 (2.4419.340.0) | | 60/240-67 (2.4419.320.0/10) |
| | | | | | | 60/641-32 (2.4419.640.0) |
| SX-1600, 1800, 2000 | 1000.6 WT | 60/161-135 (0.010.2800.1) | 60/162-135 (0.010.2800.2) | | 60/111-25 (0.009.4687.0) | 60/240-155 (2.4419.450.0) |
| | | | | | | 60/240-150 (2.4419.491.0/10) |
| XA-606, 655 | 1000.3 W | 60/161-104 (2.4249.131.0) | 60/162-25 (2.4249.130.7) | 60/97-36 (0.044.1567.0) | | 60/240-153 (2.4419.670.0/20) |
| | | 60/161-143 (0.010.2095.0) | 60/162-143 (0.010.2094.0) | | | 60/240-154 (2.4419.730.0) |
| XA-607, 657 XA-656 T XA-658 | 1000.4 W 1000.3 WT 1000.4 WT | | | | | 60/652-1 (0.9012.428.2) |
| XA-658 | 1000.4 WT | | | | | 60/240-156 (0.010.8872.0/10) |
| XN-706 XN-707 XN-708 | 1000.3 W 1000.3 WT 1000.4 W | 60/161-104 (2.4249.131.0) | 60/162-25 (2.4249.130.7) | 60/97-36 (0.044.1567.0) | 60/111-3 (2.4319.060.1) | 60/240-66 (2.4419.280.0) |
| XN-709 | 1000.4 WT | | | | | 60/240-69 (2.4419.350.0) |
| | | | | | | 60/240-159 (0.008.3100.0) |
| | | | | | | 60/652-1 (0.9012.428.2) |
| | | | | | | 60/240-157 (2.4419.680.0/10) |
| | | | | | | 60/655-6 (2.4419.483.0) |
| | | | | | | 60/240-41 (2.4419.721.0) |
| | | | | | | 60/574-7 M (2.4419.611.0) |

FILTRATION FILTERS



Hürlimann

| Tracteurs Tractors | Type Type | Air | | Huile Oil | Combustible Fuel | Hudraulique Hydraulic |
|-----------------------|--------------|---|-------------------------------------|-----------------------------------|------------------------------------|--|
| | | Ext. Out. | Int. Inn. | | | |
| | | 1 | 2 | 3 | 4 | 5 |
| XT-908, 909, 910.4 | 1000.4 WT | 60/161-104 (2.4249.310.4) | 60/162-25 (2.4249.130.7) | 60/97-22 (2.4419.340.0) | 60/111-25 (0.009.4687.0) | 60/240-155 (2.4419.450.0) |
| XT-910.6 | 1000.6 WT | 60/161-134 (0.010.2173.0) | 60/162-134 (0.010.2173.1) | 60/97-36 (0.044.1567.0) | | 60/652-1 (0.9012.428.2) |
| XT-911, 913 | 1000.6 WT | 60/161-131 (0.010.2183.0) 60/161-93 (0.009.4144.1) | 60/162-93 (2.4249.380.2) | 60/97-22 (2.4419.340.0) | | 60/240-156 (0.010.8872.0/10) |
| | | | | | | 60/240-66 (2.4419.280.0) |
| | | | | | | 60/240-69 (2.4419.350.0) |
| | | | | | | 60/240-160 (2.4419.690.0) |
| | | | | | | 60/240-161 (2.4419.750.0) |
| | | | | | | 60/240-150 (2.4419.491.0/10) |
| | | | | | | 60/652-1 (0.9012.428.2) |
| | | | | | | 60/240-66 (2.4419.280.0) |



S.L.H PARTS

Filtre hydraulique - Hydraulic filter - Hydraulikfilter - Hydrauliekfilter - Filtro hidráulico

|  | Part N° | Dimensions - Size - Abmessungen - Afmetingen -Dimensiones | Fig. |
|--|---|---|---|
| <p>SAME Antares II 110, 130 Rubin 120, 135, 150, 160, 180, 200 Silver 110, 130, 160, 180 Titan 150, 165, 190</p> <p>LAMBORGHINI Champion 120, 135, 150, 160, 180, 200 Formula 115, 135 Premium 1100, 1300, 1600, 1800 Racing 150, 165, 190</p> <p>HÜRLIMANN SX 1200, 1350, 1500, 1600, 1800, 2000 XT 911, 913 Elite XB 6115, 6135 Master H6165, H6190</p> | <p>60/240-150 (2.4419.491.0)</p> | <p>210mm x 69mm</p> |  |
| <p>SAME Diamond II 230, 260</p> <p>LAMBORGHINI Victory Plus 230, 260</p> | <p>60/240-151 (04437774)</p> | <p>230mm x 80mm</p> |  |





S.L.H PARTS

Rotules & tirants de direction - Steering links & sockets - Stuurkogels en stangen - Kugelgelenke und Spurstangen - Rótulas y acoples de dirección

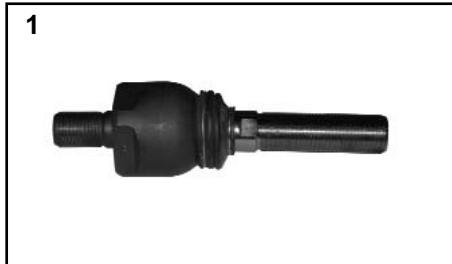

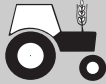



|  | Fig. | Part N° | OEM | Filet Thread Gewinde Schroefdraad Rosca | Longueur Lenght Länge Lengte Longitud | Conicité Cone Konus Conisch Cono |
|---|------|------------|--------------|---|---|--|
| Same | | | | | | |
| Diamond 230, 260 Diamond II 230, 260 | 1 | 29/497-302 | 04435178 | M26x1.5 M28x1.5 | 240mm | - |
| | 2 | 29/495-302 | 0.010.3338.0 | F28x1.5 | 470mm | 18/20 |
| Lamborghini | | | | | | |
| Victory 230, 260 Victory Plus 230, 260 | 1 | 32/497-302 | 04435178 | M26x1.5 M28x1.5 | 240mm | - |
| | 2 | 32/495-302 | 0.010.3338.0 | F28x1.5 | 470mm | 18/20 |





S.L.H PARTS

Démarrateurs - Starter motors - Anlasser - Startmotors - Motores de arranque

| Applications <i>Applications</i> | Réf. <i>Ref.</i> | OEM |  A x B  Z  L |
|-------------------------------------|---|----------------------|---|
| Lamborghini | | | |
| 503, 603 | 62/930-234 (Magneton) Avec réducteur <i>With reducer</i> 12V 2,7KW New | 01172683 01303970 | 2x105 9Z  220 |
| | 62/930-28 (Iskra) 12V 3,0KW | | 2x105 9Z  259 |





SLH PARTS

Pompe hydraulique - Hydraulic pump - Hydraulikpumpe -
hydrauliekpomp - Bomba hidráulica

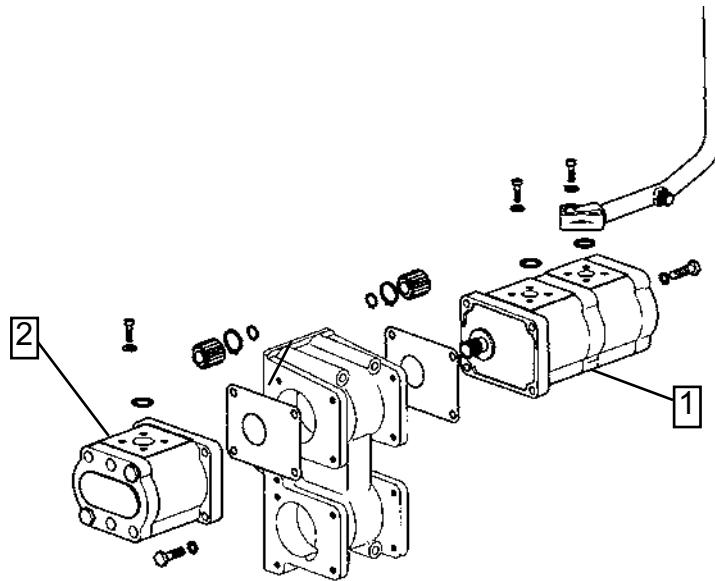

|  | 1 | 2 |
|--|--|---|
| SAME | | |
| Rubin 120 (⇒1174) Rubin 135 (⇒1410) Rubin 150 (⇒1462) Titan 145 (1445⇒) Titan 160 (2154⇒) Titan 190 (1710⇒) | 69/566-234 (2.4539.670.0/10) | |
| LAMBORGHINI | | |
| Champion 120 (⇒1096) Champion 135 (⇒1258) Champion 150 (⇒1280) Racing 150 (1243⇒) Racing 165 (1324⇒) Racing 190 (1349⇒) | ⤴ 22CC 69/566-235 (2.4539.810.0/10) | 69/565-51 (2.4539.430.0) ⤴ G / LH / L / I 14CC |
| HÜRLIMANN | | |
| H-6165 Master (1119⇒) H-6190 Master (1139⇒) SX-1200 (⇒1017) SX-1350 (⇒1043) SX-1500 (⇒1051) | | |





SLH PARTS

Embrayage - Clutch - Drukgroep - Kupplung - Embrague

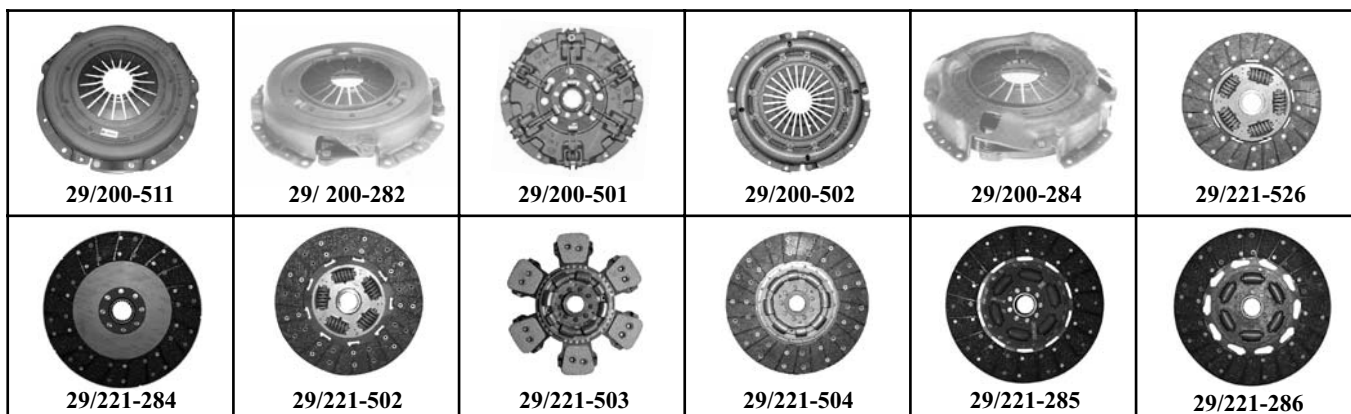

|  | Embrayage - Clutch - Drukgroep Kupplung - Embrague | | Disque - Plate - Koppelingsplaat Scheibe - Disco | | |
|--|---|--|---|--|---|
| | Ø | Part N° | Ø | Part N° | |
| SAME | | | | | |
| DORADO 55, 60, 65 EXPLORER 60, 70 II SPECIAL EXPLORER II 60, 70 GOLDEN 60V, 60, 65 COMPATTO | 280 TF | 29/200-511 (0.009.6914.3/20) 255.2320.3/10 | 280 LN | 29/221-526 (0.009.6913.3/10, 270.2330.3/10) TF 24Z 36 x 40 | 29/231-500 (2.2999.193.0) MS |
| LAMBORGHINI | | | | | |
| 574-60N, 674-70N CROSS 660S, 660V, 770S AGILE 674-70 GRAND PRIX SPRINT 654-55, 664-60, 664-65 | 280 TF | 32/200-511 (0.009.6914.3/20, 255.2320.3/10) | 280 LN | 32/221-526 (0.009.6913.3/10, 270.2330.3/10) TF 24Z 36 x 40 | 32/231-500 (2.2999.193.0) MS |
| HÜRLIMANN | | | | | |
| XA606, XA655, XA656T XN706, XN707 H358, H468 PRESTIGE H358-4, H468-4, H468-4B CLUB | 280 TF | 33/200-511 (0.009.6914.3/20) 255.2320.3/10 | 280 LN | 33/221-526 (0.009.6913.3/10, 270.2330.3/10) TF 24Z 36 x 40 | 33/231-500 (2.2999.193.0) MS |
| SAME | | | | | |
| DORADO 55, 65, 75, 85 EXPLORER 70, 80, 90T C ERGOMATIC GOLDEN 60, 65, 75, 85 COMPATTO GOLDEN 60V, 75V KRYPTON 80, 90 KRYPTON F 78M, 78N, 78C, 88M, 88N, 88C, 98M, 98N, 98C | 310 DV | 29/200-282 (0.008.4254.3/10) | 310 LN | 29/221-284 (0294.2330.3/10) UF 24Z 36 x 40 | 29/231-500 (2.2999.193.0) MS |
| LAMBORGHINI | | | | | |
| 660S, 660V, 770S, 775V, 880S, 990S AGILE C 674-70, 774-80, 874-90T, ERGOMATIC CF. 78L, 78N, 78S, 88L, 88N, 88ST, 98L, 98N, 98ST SPRINT 654-55, 664-65, 674-75, 684-85 TRIUMPH 80, 90 | 310 DV | 32/200-282 (0.008.4254.3/10) | 310 LN | 32/221-284 (0294.2330.3/10) UF 24Z 36 x 40 | 32/231-500 (2.2999.193.0) MS |
| HÜRLIMANN | | | | | |
| XA655, XA656T, XA657, XA658 XN706, XN707, XN708, XN709 | 310 DV | 33/200-282 (0.008.4254.3/10) | 310 LN | 33/221-284 (0294.2330.3/10) UF 24Z 36 x 40 | 33/231-500 (2.2999.193.0) MS |

Les références des pièces sont indicatives.
Nos pièces ne sont pas d'origine.

Part numbers are quoted for reference purposes only.
Our parts and accessories are not original.



"THE RELIABLE SERVICE"



SLH PARTS

|  | Embrayage - Clutch - Drukgroep Kupplung - Embrague | | Disque - Plate - Koppelingsplaat Scheibe - Disco | | |
|---|---|---|---|--|---|
| | Ø | Part N° | Ø | Part N° | |
| SAME | | | | | |
| DORADO 70, 75, 85 EXPLORER 70, 70BASSO, 80BASSO II SPECIAL EXPLORER II 60, 70, 80, 90T GOLDEN 75, 85 COMPATTO GOLDEN 75V | 310 GU6 | 29/200-501 (294.2320.3) | 310 LN | 29/221-502 (009.6924.3/20, 445.2330.3) TF 24Z 36 x 40 | 29/231-500 (2.2999.193.0) MS |
| LAMBORGHINI | | | | | |
| 674-70, 774-80, 874-90T GRAND PRIX 674-70N, 674-70NB CROSS 775V, 880S, 990S AGILE SPRINT 674-70, 674-75, 684-85 | 310 GU6 | 32/200-501 (294.2320.3) | 310 LN | 32/221-502 (009.6924.3/20, 445.2330.3) TF 24Z 36 x 40 | 32/231-500 (2.2999.193.0) MS |
| HÜRLIMANN | | | | | |
| H358, H468, H478, H488T PRESTIGE H468-4, H468-4B CLUB XA607, XA657, XA658 XN708, XN709 | 310 GU6 | 33/200-501 (294.2320.3) | 310 LN | 33/221-502 (009.6924.3/20, 445.2330.3) TF 24Z 36 x 40 | 33/231-500 (2.2999.193.0) MS |
| SAME | | | | | |
| ANTARES 110 II EXPLORER II 90T EXPLORER SPECIAL 80, 90, 80LP, 90LP ROW CROP 90, 100, 100.6 SILVER 80, 90, 100.4, 100.6, 110 | 330 DV | 29/200-502 (0.010.8764.3/10, 008.4184.3) | 330 LN | 29/221-503 (0.010.7535.3/10, 009.6533.3) TC-LT 24Z 36,5 x 41 | 29/231-513 (2.2999.207.0) MS 55 x 91 |
| EXPLORER II 90T EXPLORER SPECIAL 80, 90, 80LP, 90LP SILVER 80, 90, 100.4, 100.6 | | | 330 LN | 29/221-504 (008.9937.3) TF 24Z 36,5 x 41 | |
| LAMBORGHINI | | | | | |
| 850, 950, 1050, 1060, 1100 PREMIUM FORMULA 115 | 330 DV | 32/200-502 (0.010.8764.3/10, 008.4184.3) | 330 LN | 32/221-503 (0.010.7535.3/10, 009.6533.3) TC-LT 24Z 36,5 x 41 | 32/231-513 (2.2999.207.0) MS 55 x 91 |
| HIGH CLEARANCE 90 | | | 330 LN | 32/221-504 (008.9937.3) TF 24Z 36,5 x 41 | |
| 850, 950, 1050, 1060 PREMIUM | | | | | |
| HÜRLIMANN | | | | | |
| ELITE XB 6115 XT 908, 909, 910.4, 910.6, 911 | 330 DV | 33/200-502 (0.010.8764.3/10, 008.4184.3) | 330 LN | 33/221-503 (0.010.7535.3/10, 009.6533.3) TC-LT 24Z 36,5 x 41 | 33/231-513 (2.2999.207.0) MS 55 x 91 |
| XT 908, 909, 910.4, 910.6 | | | 330 LN | 29/221-504 (008.9937.3) TF 24Z 36,5 x 41 | |

Les références des pièces sont indicatives.
Nos pièces ne sont pas d'origine.

Part numbers are quoted for reference purposes only.
Our parts and accessories are not original.



"THE RELIABLE SERVICE"





TRACPIECES

**PRODUCT
NEWS-SHEET**

PAGE : N° 7543

DATE : 10/06

SLH PARTS

|  | Embrayage - Clutch - Drukgroep Kupplung - Embrague | | Disque - Plate - Koppelingsplaat Scheibe - Disco | | |
|--|---|-------------------------------------|---|--|---|
| | Ø | Part N° | Ø | Part N° | |
| SAME | | | | | |
| ANTARES 110 II EXPLORER II 80, 90T EXPLORER SPECIAL 80, 90, 80LP, 90LP ROW CROP 100.6 SILVER 80, 90, 100.4, 100.6, 110 | 350 DV | 29/200-284 (0.010.6912.3) | 330 LN | 29/221-285 (0.007.7928.3/10) TC 24Z 36 x 41 | 29/231-500 (2.2999.193.0) MS |
| | | | 350 LN | 29/221-286 (0.007.7929.3/20) TC 24Z 36 x 41 | |
| LAMBORGHINI | | | | | |
| 774-80, 774-80N, 874-90T GRAND PRIX 850, 950, 1050, 1060, 1100 PREMIUM FORMULA 115 | 350 DV | 32/200-284 (0.010.6912.3) | 330 LN | 32/221-285 (0.007.7928.3/10) TC 24Z 36 x 41 | 32/231-500 (2.2999.193.0) MS |
| | | | 350 LN | 32/221-286 (0.007.7929.3/20) TC 24Z 36 x 41 | |
| HÜRLIMANN | | | | | |
| H478, H488T PRESTIGE H478-4 ELITE XB 6115 XT 908, 909, 910.4, 910.6, 911 | 350 DV | 33/200-284 (0.010.6912.3) | 330 LN | 32/221-285 (0.007.7928.3/10) TC 24Z 36 x 41 | 33/231-500 (2.2999.193.0) MS |
| | | | 350 LN | 32/221-286 (0.007.7929.3/20) TC 24Z 36 x 41 | |

GU6 = Commande indépendante, 6 doigts / Independent clutch, 6 levers / Unabhängiggeschaltet / Onafhankelijke bediening, 6 vingers / Independiente, 6 pastillas

MS = Petit Ø / Small diameter / Mit kleinem Durchmesser / Kleine Ø / Pequeño Ø

DV = Diaphragme, volant creux / Diaphragm, pot flywheel / Tellerfeder, vertieftes / Diafragma, geen vlak vliegwiel / Diafragma, volante rebajado

LN = Friction d'avancement côté moteur, libre / Main disc, eginge side, loose / Fahrscheibe Motorseitig, lose / Loose rijplaat aan motorzijde / Disco principal, lado motor libre

LT = 6 paires de pastilles / 6 pairs of pads / 6 Paar Beläge / Met 6 paar pads / Con 6 pares de palas

TC = Cera-métallique à ressort / Spring cera-metallic / Cerasinter-Belag, gefedert / Sintermetaal met veren / Cerametalico con muelles

TF = Organique à ressort / Spring organic / Organischer-Belag, gefedert / Organisch met veren / Orgánico con muelles

UF = Organique fixe / Fixed organic / Organischer-Belag, ungefedert / Organisch zonder veren / Orgánico sin muelles

UC = Cera-métallique fixe / Fixed cera-metallic / Cerasinter-Belag, ungefedert / Sintermetaal vast, niet geveerd / Cerametalico sin muelles

Les références des pièces sont indicatives.
Nos pièces ne sont pas d'origine.

Part numbers are quoted for reference purposes only.
Our parts and accessories are not original.







"THE RELIABLE SERVICE"



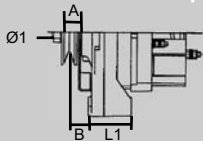
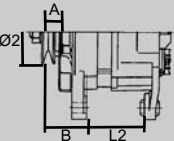

S.L.H PARTS

Alternateur - Alternator - Drehstromlichtmaschine - Wisselstroomdynamo - Alternador

|  | Parts N° |  |  |  |
|---|--|---|--|---|
| <p>SAME Dorado 55, 60, 65, 70, 75, 85 Golden 60, 65, 75, 85 compatto Golden 60V, 75V</p> <p>LAMBORGHINI 660-V Agile 775-V Agile</p> | <p>62/920-165 (2.9439.440.10)</p> | <p>14V / 70A</p> |  <p>  Ø1 L1 15 29 </p> | |





S.L.H PARTS

Vitre de cabine - Cab glass - Kabinenscheiben - Kabineruiten - Cristal de cabina

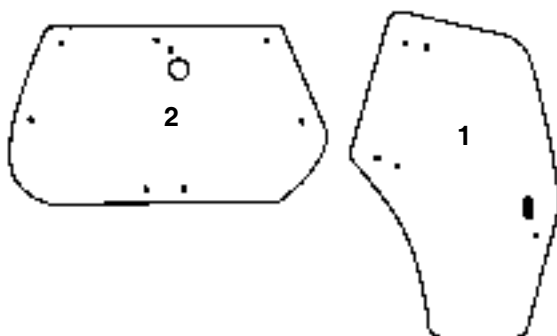

|  | Fig. | Parts N° | OEM | Pos. | Specification | | | |
|---|------|--------------------|----------|------|---------------|-------------|---|-----|
| SAME | | | | | | | | |
| Diamond II 230, 260 Rubin 120, 135, 150, 160, 180, 200 | 1 | 29/4039-41T | 04418951 | C | L-6H-CO | 1525x1120x6 | T | BLT |
| | 1 | 29/4038-41T | 04418952 | C | R-6H-CO | 1525x1120x6 | T | BLT |
| | 2 | 29/4072-92T | 04429137 | E | 9H-CO | 1420x895x5 | T | BLT |
| LAMBORGHINI | | | | | | | | |
| Champion 120, 135, 150, 160, 180, 200 Victory Plus 230, 260 | 1 | 32/4039-41T | 04418951 | C | L-6H-CO | 1525x1120x6 | T | BLT |
| | 1 | 32/4038-41T | 04418952 | C | R-6H-CO | 1525x1120x6 | T | BLT |
| | 2 | 32/4072-92T | 04429137 | E | 9H-CO | 1420x895x5 | T | BLT |
| HÜRLIMANN | | | | | | | | |
| SX1200, SX1350, SX1500, SX1600, SX1800, SX2000 | 1 | 33/4039-41T | 04418951 | C | L-6H-CO | 1525x1120x6 | T | BLT |
| | 1 | 33/4038-41T | 04418952 | C | R-6H-CO | 1525x1120x6 | T | BLT |
| | 2 | 33/4072-92T | 04429137 | E | 9H-CO | 1420x895x5 | T | BLT |

C = Porte / Door / Türscheibe / Deur / Puerta
E = Arrière haut / Upper rear / Hinten oben / Achteraan bovenaan / Trasero superior
6H = 6 Trous / 6 Holes / 6 Bohrungen / 6 Gaten / 6 Agujeros
9H = 9 Trous / 9 Holes / 9 Bohrungen / 9 Gaten / 9 Agujeros
CO = Convexe / Curved / Konvex / Convex / Convexo
L = Gauche / Left / Links / Links / Izquierdo
R = Droite / Right / Rechts / Rechts / Derecho
T = Tintée / Tinted / Getönt / Getint / Tintado
BLT = Visser / Bolt on / Fest / Vast / con tornillos / Fijo





SLH PARTS

**Pompe d'alimentation - Fuel pump - Kraftstoffförderpump -
Opvoerpomp - Bomba de gas-oil**







|  | Part N° | OEM |
|---|------------------|----------------------|
| SAME | | |
| Diamond 230, 260 Diamond II 230, 260 | 29/100-45 | 04207013 02112672 |
| LAMBORGHINI | | |
| Victory 230, 260 Victory Plus 230, 260 | 32/100-45 | 04207013 02112672 |





S.L.H PARTS

Amortisseur de torsion - Torsion damper - Torsiondämpfer - Torsiedemper -
Amortiguador de torsión

|  | Parts N° | Dimensions | |
|---|------------------------------------|-----------------|---|
| SAME | | | |
| SILVER 80, 90, 100.4, 100.6 Hydrive | 29/196-31 (0.011.3942.4) | 24Z 45,3 x 48.9 |  |
| LAMBORGHINI | | | |
| PREMIUM 850, 950, 1050, 1060 Directronic | 32/196-31 (0.011.3942.4) | 24Z 45,3 x 48.9 |  |
| HÜRLIMANN | | | |
| XT908, XT909, XT910.4, XT910.6 Fastdrive | 33/196-31 (0.011.3942.4) | 24Z 45,3 x 48.9 |  |





SLH PARTS

Filtre hydraulique (PTO) - Hydraulic filter (PTO)- Hydraulikfilter (Zapfwelle) -
Hydrauliekfilter (Aftakas) - Filtro hidráulico (PDF)

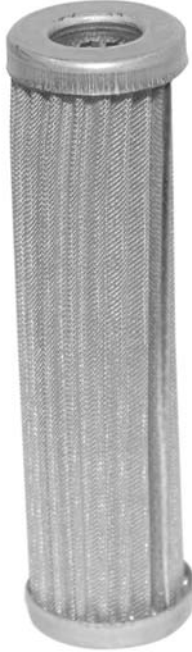
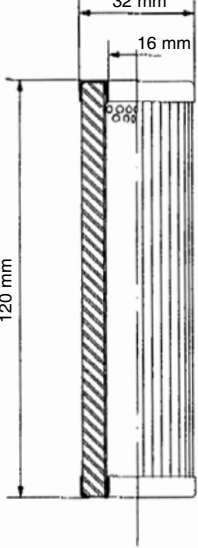
|  | Part N° | Fig. | |
|--|---|---|---|
| <p>SAME ANTARES 110, 130 II ASTER 60, 70 DORADO 55, 60, 65, 70, 75, 85 EXPLORER 60, 70, 70BASSO, 80BASSO II SPECIAL EXPLORER II 60, 70, 80, 90T FRUTTEO 60, 75, 85 II GOLDEN 60, 65, 75, 85 COMPATTO ROW CROP 100.6 RUBIN 120, 135, 150, 160, 180, 200 RUBIN 160, 180, 200 GALILEO SILVER 80, 90, 100.4, 100.6, 110, 130, 160, 180 TITAN 145, 160, 190 TITAN 150N 165N 190 SUPERTITAN</p> | | | |
| <p>LAMBORGHINI 574-60N, 674-70N, 674-70NB CROSS 600, 700 660F, 775F, 880F, 990F PLUS 660S, 770S, 880S, 990S AGILE 674-70, 774-80, 874-90T GRAND PRIX 850, 950, 1050, 1060 PREMIUM CHAMPION 120, 135, 150, 160, 180, 200 CHAMPION 160, 180, 200 INTEL-CAB FORMULA 115, 135 PREMIUM 1100, 1300, 1600, 1800 RACING 150, 165, 190 RACING 150, 165, 190 HI. PER. SPRINT 654-55, 664-60, 664-65, 674-70, 674-75, 684-85</p> | <p>60/652-1 (0.9012.428.2)</p> |  |  |
| <p>HÜRLIMANN XA606, XA607, XA655, XA656T, XA657, XA658 H358, H468, H478, H488T PRESTIGE H358, H468, H468-4B CLUB H361, H476, H481, H491 XF H362, H372 H6165, H6190 MASTER SX1200, SX1350, SX1500, SX1600, SX1800, SX2000 XN706, XN707, XN708, XN709 XT908, XT909, XT910.4, XT910.6, XT911, XT913 ELITE XB 6115, 6135 MASTER H6165, H6190 HP</p> | | | |





TRACPIECES



**PRODUCT
NEWS-SHEET**

**PAGE : N°7412
DATE : 07/05**

SLH PARTS

Filtre d'aspiration (hydraulique) - Breather filter (hydraulic) - Saugfilter (hydraulik) - Aanzuigfilter (hydrauliek) - Filtro hidràulicode aspiración



|  | Part N° | OEM | |
|---|------------------|--------------|---|
| SAME GOLDEN 60, 65, 75, 85 COMPATTO GOLDEN 60V, 70V RUBIN 120, 135, 150 RUBIN 160, 180, 200 GALILEO SILVER 160, 180 TITAN 150, 165, 190 SUPERTITAN | 60/641-32 | 2.4419.640.0 |  |
| LAMBORGHINI 660S, 770S, 880S, 990S, 660V, 775V AGILE CHAMPION 120, 135, 150 CHAMPION 160, 180, 200 INTEL-CAB PREMIUM 1600, 1800 RACING 150, 165, 190 HI. PER. | | | |
| HÜRLIMANN SX-1200, SX-1350, SX-1500 XN-706, XN-707, XN-708, XN-709 MASTER H-6165, H-6190 HP | | | |

Les références des pièces sont indicatives.
Nos pièces ne sont pas d'origine.

Part numbers are quoted for reference purposes only.
Our parts and accessories are not original.



"THE RELIABLE SERVICE"





S.L.H PARTS

Vitre de cabine - Cab glass - Kabinenscheiben - Kabineruiten - Cristal de cabina

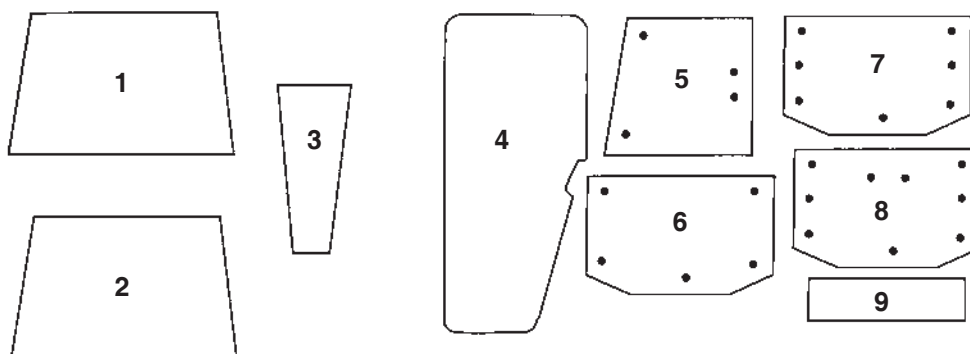

|  | Fig. | Parts N° | OEM | Pos. | Specification | | |
|---|------|--------------------|---------------|------|---------------|------------|-------|
| SAME | | | | | | | |
| Explorer 55, 60, 65, 70, 75, 80, 90T, 90TII | 1 | 29/4001-27 | 9231 210 0/10 | A | | 857x782x5 | GR |
| | 2 | 29/4001-28 | 9241 210 0 | A | | 858x772x5 | GR |
| | 3 | 29/4014-9T | 9231 211 0/10 | B | L & R | 635x163x6 | GR |
| | 4 | 29/4020-41 | 9231 212 0 | C | L & R | 1360x555x5 | GR |
| | 5 | 29/4047-85T | 9231 214 0 | D | L & R - 4H | 723x660x6 | K/BLT |
| | 6 | 29/4072-96T | 9231 215 0 | E | 5H | 1240x778x6 | K/BLT |
| | 7 | 29/4072-97T | 9231 268 0 | E | 7H | 1240x778x6 | K/BLT |
| | 8 | 29/4072-98T | 9231 268 0/20 | E | 9H | 1240x778x6 | GR |
| | 9 | 29/4073-46 | 9231 255 0 | F | | 880x366x4 | GR |
| LAMBORGHINI | | | | | | | |
| 674-70, 774-80, 874-90 | 2 | 32/4001-28 | 9241 210 0 | A | | 858x772x5 | GR |
| | 3 | 32/4014-9T | 9231 211 0/10 | B | L & R | 635x163x6 | GR |
| | 4 | 32/4020-41 | 9231 212 0 | C | L & R | 1360x555x5 | GR |
| | 5 | 32/4047-85T | 9231 214 0 | D | L & R - 4H | 723x660x6 | K/BLT |
| | 6 | 32/4072-97T | 9231 268 0 | E | 7H | 1240x778x6 | K/BLT |
| | 9 | 32/4073-46 | 9231 255 0 | F | | 880x366x4 | GR |
| HÜRLIMANN | | | | | | | |
| 356, 358, 446, 468, 476, 478, 488 | 1 | 33/4001-27 | 9231 210 0/10 | A | | 857x782x5 | GR |
| | 3 | 33/4014-9T | 9231 211 0/10 | B | L & R | 635x163x6 | GR |
| | 4 | 33/4020-41 | 9231 212 0 | C | L & R | 1360x555x5 | GR |
| | 5 | 33/4047-85T | 9231 214 0 | D | L & R - 4H | 723x660x6 | K/BLT |
| | 6 | 33/4072-96T | 9231 215 0 | E | 5H | 1240x778x6 | K/BLT |
| | 7 | 33/4072-97T | 9231 268 0 | E | 7H | 1240x778x6 | K/BLT |
| | 9 | 33/4073-46 | 9231 255 0 | F | | 880x366x4 | GR |

Les références des pièces sont indicatives.
Nos pièces ne sont pas d'origine.

Part numbers are quoted for reference purposes only.
Our parts and accessories are not original.



"THE RELIABLE SERVICE"



S.L.H PARTS

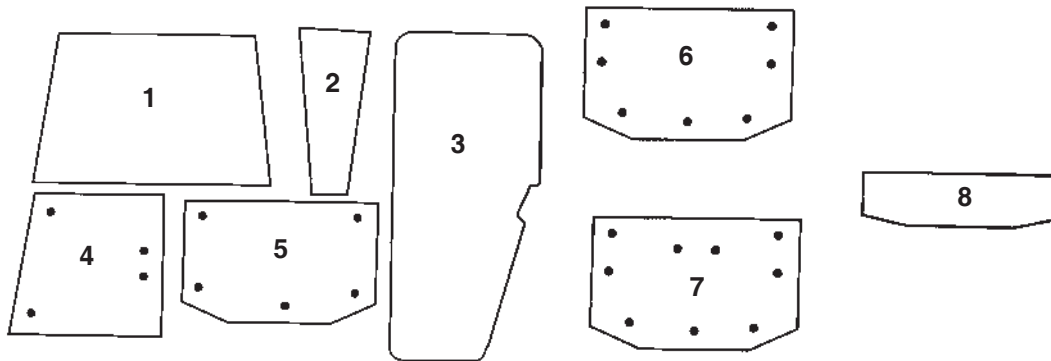

|  | Fig. | Parts N° | OEM | Pos. | Specification | | | |
|---|------|--------------|---------------|------|---------------|------------|---|-------|
| SAME | | | | | | | | |
| LASER 90, 100, 110, 130, 150 GALAXY 90, 100, 110, 130, 150 | 1 | 29/4001-29 | 9234 210 0/30 | A | | 1000x745x6 | T | GR |
| | 2 | 29/4014-10T | 9234 211 0/10 | B | L & R | 662x197x6 | T | GR |
| | 3 | 29/4020-44T | 9234 212 0/20 | C | L & R | 1360x588x5 | T | GR |
| | 4 | 29/4047-86T | 9234 214 0/20 | D | L & R - 4H | 745x600x6 | T | K/BLT |
| | 5 | 29/4072-99T | 9234 215 0/20 | E | 5H | 1217x815x6 | T | K/BLT |
| | 6 | 29/4072-100T | 9234 273 0 | E | 7H | 1217x815x6 | T | K/BLT |
| | 7 | 29/4072-101T | 2905545 | E | 9H | 1217x815x6 | T | K/BLT |
| | 8 | 29/4073-96T | 9234 216 0/20 | F | | 800x350x4 | T | GR |
| LAMBORGHINI | | | | | | | | |
| 956, 1106, 1306 | 1 | 32/4001-29 | 9234 210 0/30 | A | | 1000x745x6 | T | GR |
| | 2 | 32/4014-10T | 9234 211 0/10 | B | L & R | 662x197x6 | T | GR |
| | 3 | 32/4020-44T | 9234 212 0/20 | C | L & R | 1360x588x5 | T | GR |
| | 4 | 32/4047-86T | 9234 214 0/20 | D | L & R - 4H | 745x600x6 | T | K/BLT |
| | 6 | 32/4072-100T | 9234 273 0 | E | 7H | 1217x815x6 | T | K/BLT |
| | 8 | 32/4073-96T | 9234 216 0/20 | F | | 800x350x4 | T | GR |
| HÜRLIMANN | | | | | | | | |
| 496, 5116, 6136, 6170 | 1 | 33/4001-29 | 9234 210 0/30 | A | | 1000x745x6 | T | GR |
| | 2 | 33/4014-10T | 9234 211 0/10 | B | L & R | 662x197x6 | T | GR |
| | 3 | 33/4020-44T | 9234 212 0/20 | C | L & R | 1360x588x5 | T | GR |
| | 4 | 33/4047-86T | 9234 214 0/20 | D | L & R - 4H | 745x600x6 | T | K/BLT |
| | 5 | 33/4072-99T | 9234 215 0/20 | E | 5H | 1217x815x6 | T | K/BLT |
| | 6 | 33/4072-100T | 9234 273 0 | E | 7H | 1217x815x6 | T | K/BLT |
| | 8 | 33/4073-96T | 9234 216 0/20 | F | | 800x350x4 | T | GR |

Les références des pièces sont indicatives.
Nos pièces ne sont pas d'origine.

Part numbers are quoted for reference purposes only.
Our parts and accessories are not original.



"THE RELIABLE SERVICE"



S.L.H PARTS

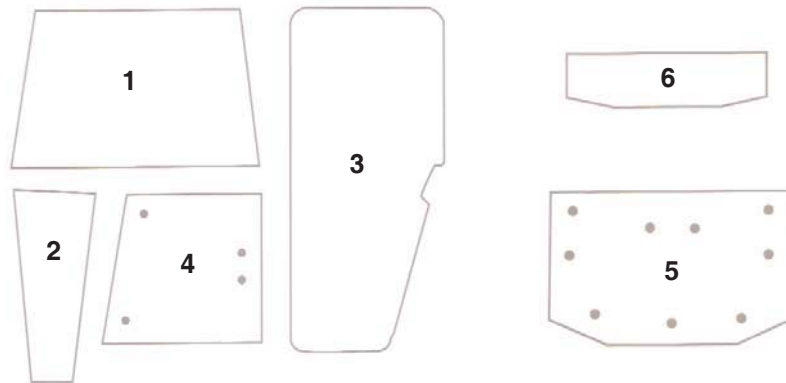

|  | Fig. | Parts N° | OEM | Pos. | Specification | | |
|---|------|-------------|---------------|------|---------------|------------|-------|
| SAME | | | | | | | |
| ANTARES I 100 | 1 | 29/4001-28 | 9241 210 0 | A | | 858x772x5 | GR |
| | 2 | 29/4014-9T | 9231 211 0/10 | B | L & R | 635x163x6 | GR |
| | 3 | 29/4020-41 | 9231 212 0 | C | L & R | 1360x555x5 | GR |
| | 4 | 29/4047-85T | 9231 214 0 | D | L & R - 4H | 723x660x6 | K/BLT |
| | 5 | 29/4072-98T | 9231 268 0/20 | E | 9H | 1240x778x6 | K/BLT |
| | 6 | 29/4073-46 | 9231 255 0 | F | | 880x366x4 | GR |

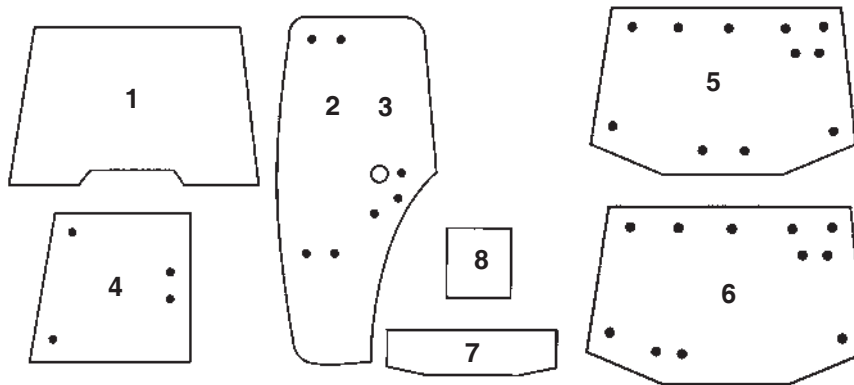

|  | Fig. | Parts N° | OEM | Pos. | Specification | | |
|---|------|--------------|---------------|------|---------------|------------|-------|
| SAME | | | | | | | |
| ANTARES II 110, 130 | 1 | 29/4000-100 | 009 0300 0 | A | | 1045x795x6 | B |
| | 2 | 29/4038-44T | 00773360/10 | C | R - 8H | 1464x826x6 | K/BLT |
| | 3 | 29/4039-44T | 00773350/10 | C | L - 8H | 1464x826x6 | K/BLT |
| | 4 | 29/4047-87T | 007 5106 0/10 | D | L & R - 4H | 780x542x6 | K/BLT |
| | 5 | 29/4072-85T | 007 5181 0/20 | E | 11H | 1360x830x6 | K/BLT |
| | 6 | 29/4072-102T | 009 1306 0 | E | 11H | 1360x830x6 | K/BLT |
| | 7 | 29/4073-97T | 007 5312 0/10 | F | | 850x275x5 | GR |
| | 8 | 29/4073-98T | 009 0969 0 | F | | 338x264x5 | GR |

Les références des pièces sont indicatives.
Nos pièces ne sont pas d'origine.

Part numbers are quoted for reference purposes only.
Our parts and accessories are not original.



S.L.H PARTS

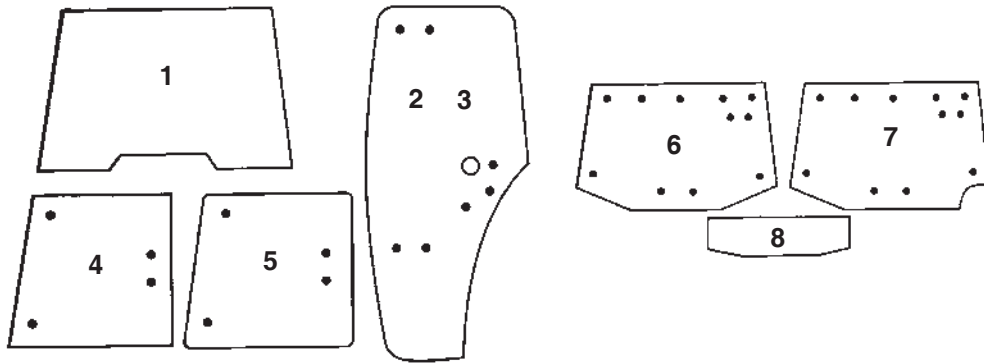

|  | Fig. | Parts N° | OEM | Pos. | Specification | | | |
|---|------|-------------|---------------|------|---------------|------------|----|-------|
| SAME | | | | | | | | |
| SILVER 80, 90, 100-4, 100-6 | 1 | 29/4000-100 | 009 0300 0 | A | | 1045x795x6 | CL | B |
| | 2 | 29/4038-44T | 00773360/10 | C | R - 8H | 1464x826x6 | T | K/BLT |
| | 3 | 29/4039-44T | 00773350/10 | C | L - 8H | 1464x826x6 | T | K/BLT |
| | 4 | 29/4047-87T | 007 5106 0/10 | D | L & R - 4H | 780x542x6 | T | K/BLT |
| | 5 | 29/4047-88T | 007 7337 0/10 | D | L & R - 4H | 775x535x6 | T | K/BLT |
| | 6 | 29/4072-85T | 007 5181 0/20 | E | 11H | 1350x830x6 | T | K/BLT |
| | 7 | 29/4072-86T | 007 7338 0/10 | E | 11H | 1350x830x6 | T | K/BLT |
| | 8 | 29/4073-97T | 007 5312 0/10 | F | | 850x275x5 | T | GR |

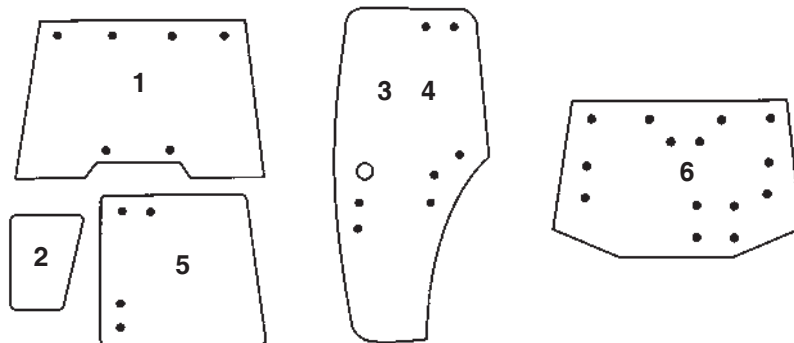

|  | Fig. | Parts N° | OEM | Pos. | Specification | | | |
|---|------|--------------|-------------|------|---------------|------------|----|-------|
| SAME | | | | | | | | |
| ASTER 60, 70 | 1 | 29/4000-103 | 00827210/20 | A | O - 6H | 1103x910x6 | CL | K/BLT |
| | 2 | 29/4014-11T | 00827220/10 | B | L & R | 555x262x6 | T | GR |
| | 3 | 29/4039-45T | 00823370/10 | C | L- 8H | 1467x825x6 | T | K/BLT |
| | 4 | 29/4038-45T | 00823360/10 | C | R- 8H | 1467x825x6 | T | K/BLT |
| | 5 | 29/4047-89T | 00824070/10 | D | L & R - 4H | 640x447x5 | T | K/BLT |
| | 6 | 29/4047-103T | 00728600 | E | 14H | 1213x823x6 | T | K/BLT |

A = Pare-brise / Windscreen / Frontscheibe / Voorruit / Parabrisa
 B = Avant bas / lower front / Vorne / Voorruit / Delantero inferior
 C = Porte / Door / Türscheibe / Deur / Puerta
 D = Latérale / Side / Seite / Zijkant / Lateral
 E = Arrière haut / Upper rear / Hinten oben /
 Achteraan bovenaan / Trasero superior
 F = Arrière bas / Lower rear / Hinten unten /
 Achteraan beneden / Trasero inferior
 4H = 4 Trous / 4 Holes / 4 Bohrungen / 4 Gaten / 4 Agujeros
 5H = 5 Trous / 5 Holes / 5 Bohrungen / 5 Gaten / 5 Agujeros
 6H = 6 Trous / 6 Holes / 6 Bohrungen / 6 Gaten / 6 Agujeros
 7H = 7 Trous / 7 Holes / 7 Bohrungen / 7 Gaten / 7 Agujeros
 8H = 8 Trous / 8 Holes / 8 Bohrungen / 8 Gaten / 8 Agujeros
 9H = 9 Trous / 9 Holes / 9 Bohrungen / 9 Gaten / 9 Agujeros

11H = 11 Trous / 11 Holes / 11 Bohrungen / 11 Gaten / 11 Agujeros
 14H = 14 Trous / 14 Holes / 14 Bohrungen / 14 Gaten / 14 Agujeros
 L = Gauche / Left/ Links / Links / Izquierda
 O = Ouvrant / Opening / Öffnet / Schuifdak / Abatible
 R = Droite / Right / Rechts / Rechts / Derecho
 T = Tintée / Tinted / Getönte / Getint / Tintado
 CL = Claire / Clear/ Klar / Helder / Claro
 BO = Bombée / Bonded / Gewölbt / Bol / Abombado
 BLT = Visser / Bolt on / Fest / Vast / Fijado
 FR = Encadrée / Framed/ Eingerahnt / Omkaderd / Marco
 GR = Avec joint / Glazing rubber / Dichtung / Ruitrubbers / Con perfil
 K = Avec butoir caoutchouc / Knock on rubber / Mit Gummi Einlage
 Rubber inzetring / Con goma

Les références des pièces sont indicatives.
 Nos pièces ne sont pas d'origine.

Part numbers are quoted for reference purposes only.
 Our parts and accessories are not original.





SLH PARTS

Pompe hydraulique - Hydraulic pump - hydrauliekpompe -
Hydraulikpump - Bomba hidráulica



|  | Part N° | OEM | Débit - Flow - Druck - Debiet - Flujo | ↻ |
|---|-------------------|--------------|--|------------------------------|
| SAME DORADO 55, 60, 56, 70, 75, 85 | 69/565-233 | 2.4539.090.0 | 19 cc. | Gauche - LH - L. - Izqda. |
| LAMBORGHINI SPRINT 654-55, 664-60, 664-65, 674-70, 674-75, 684-85 | | | | |
| HÜRLIMANN XA-606, XA-607, XA655, XA-657, XA-658, XA656T | | | | |





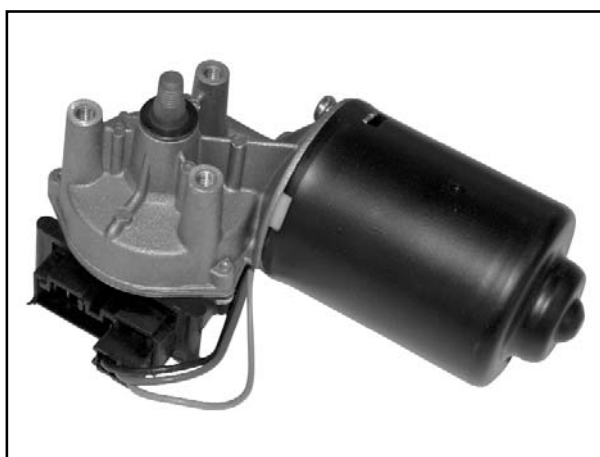

SLH PARTS

Moteur d'essuie-glace - Wiper motor - Ruitenwissermotor
Scheibenwischermotor - Motor del limpiaparabrisa

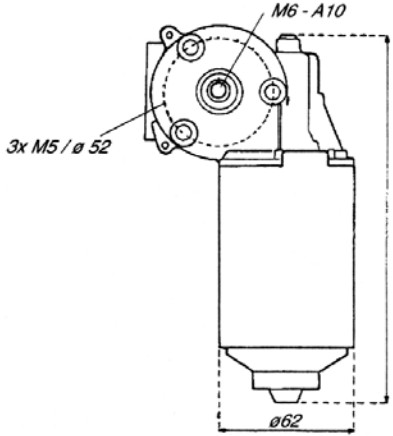

|  | Part N° | V. |  Nm | |
|---|--------------------------------------|-----|--|--|
| SAME ANTARES 110, 130 II EXPLORER II 60, 70, 80, 90T LASER 100, 110, 130, 150 ROW CROP 100.6 SILVER 80, 90, 100.4, 100.6, 110, 130, 160, 180 TITAN 145, 160, 190 TITAN 150, 165, 190 SUPERTITAN | | | | |
| LAMBORGHINI 956-100, 1106, 1306, 1506 674-70, 774-80, 874-90T GRAND PRIX PREMIUM 850, 950, 1050, 1060, 1100, 1300 FORMULA 115, 135 RACING 150, 165, 190, 190 HI.PER. | 63/1980-14 2.9019.070.0/10 | 12V | 360° |  |
| HÜRLIMANN H358, H468, H478, H488T PRESTIGE H6165, H6190 MASTER ELITE XB 6115, 6135 MASTER H6165, H6190 H.P. XT908, XT990, XT910.4, XT910.6, XT911, XT913 | | | | 2 vitesses / 2 speed / 2 Geschwindigkeiten 2 snelheden / 2 velocidades intermittent - intervall intermetierend - intermitente 40/58 RPM |





S.L.H PARTS

**Flotteur de réservoir - Fuel sender unit - Tankschwimmer -
Tankvlotter - Flotador**

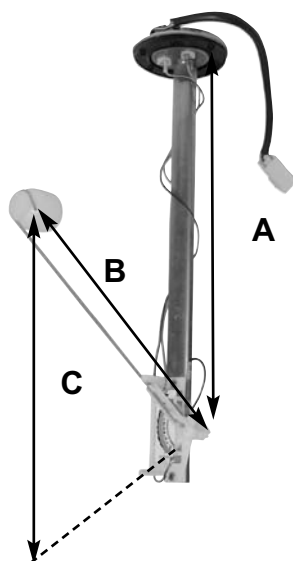

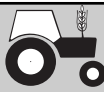







|  | Part N° | Oem | Observation |
|---|-------------------|-----------------|--|
| Frutteto 60II, 75II, 85II 660F, 775F PLUS H361, H476-F | 29/172-102 | 2.7059.590.0/10 | A : 280mm - B : 235mm C : 452mm - 6 Holes |





SAME PARTS

Optiques - Front lights - Frontscheinwerfer - Koplamp - Faros delanteros

| Part N° |  | Fig. |  |
|--|---|--|---|
|  29/189-60 280297100/02 | 1x 63/1955-410 12V 45/50W Asym. - Asim. |  | |
|  29/189-61 280297400/21 | 1x 63/1955-472 H4 12V 55-60W |  | |
|  29/189-62 280297600/30 | 1x 63/1955-472 H4 12V 55-60W |  | ARGON 50, 55, 60, 65, 70, 75F DORADO 55, 60, 65, 70, 75, 85 EXPLORER II 60, 70, 80, 90T FRUTTETO 60, 75, 85II GOLDEN 60, 65, 75, 85 COMPATTO GOLDEN 60V, 75V KRYPTON 80, 90, 100 KRYPTON F 78M, 78N, 78C, 88M, 88N, 88C, 98M, 98N, 98C ROCK 50, 60, 70 ROW CROP 100.6 RUBIN 120, 135, 150 SILVER 80, 90, 100.4, 100.6, 110, 130 |



Phare - Headlamp - Werklamp
Scheinwerfer - Faro



Cabochon - Glass - Glas
Glas - Tulipa



Ampoule - Bulb - Gloeilamp
Glühlampe - Bombilla

Les références des pièces sont indicatives.
Nos pièces ne sont pas d'origine.

Part numbers are quoted for reference purposes only.
Our parts and accessories are not original.

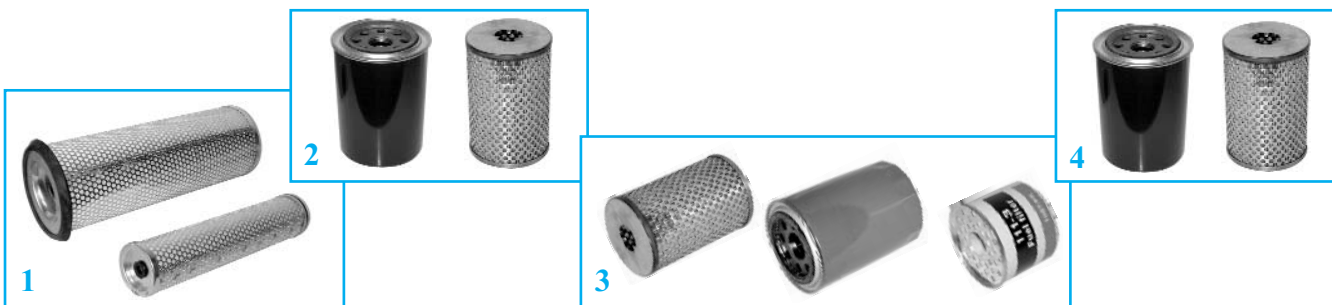

SAME (SUPPLEMENT)

| Tracteurs Tractors | 1 | | 2 | 3 | 4 |
|-----------------------|---|---|--|---|---|
| | Air | | Huile Oil | Combustible Fuel | Hydraulique Hydraulic |
| | Ext. / Out. | Int. / Inn. | | | |
| Frutteto I 60, 75 | 60/161-112 (242493401) | 60/162-112 (242493402) | 60/97-36 (04415670, 04415510) | 60/111-3 (243190601) (Repl. CAV 296) | 60/240-69 (244192800, 244193500) |
| Frutteto I 85 | | | 60/97-22 (244193400) | | |
| Frutteto II 60, 75 | 60/161-104 (242491300, 242491310, 242493100/10, 242493104) | 60/162-25 (242491302, 242491307, 242491309) | 60/97-36 (04415670, 04415510) | | |
| Frutteto II 85 | | | 60/97-22 (244193400) | | |
| Golden 60, 65, 75, 85 | | | 60/111-25 (00946870) | | |
| Dorado 70 | | | 60/97-36 (04415670, 04415510) | | |



SAME (SUPPLEMENT)

Les références des pièces sont indicatives.
Nos pièces ne sont pas d'origine.

*Part numbers are quoted for reference purposes only.
Our parts and accessories are not original.*

COUSSINETS (REFROIDISSEMENT PAR AIR)
BEARINGS (AIR COOLING)

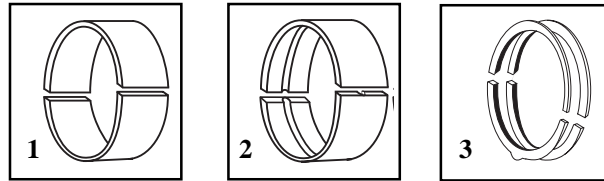

SAME

| Figures | 1 | 2 | 3 |
|--|--|---|---|
| Tracteurs <i>Tractors</i> | Coussinets de bielle <i>Conrod bearings</i> (Par cyl. / Per cyl.) | Coussinets de palier <i>Main bearings</i> (Par palier / Per hub) | Epaisseurs latérales <i>Thrust washers</i> (Par mot. / Per engine) |
| Aurora, Buffalo 120, Corsaro, Delfino (1973 ⇄), Drago 100, 120, Falcon, Minitauro, Minitauro 60, Panther, Saturno, Sirenetta (1973 ⇄), Laser 150, Hercules, Galaxy Solar 50, 60, Tiger 100, Moteurs 982, 983, 984, 985, 986, 1052, DA 1053, 1054, 1055, 1056 <i>Engines</i> | 062.1225K (2x 062.1225.0) Larg. / Width : 27mm | 073.1215K (2x 029.1215.0) Larg. / Width : 32mm | 042.1218K (2x 042.1218.0 + 2x 042.1219.0) |
| Antarès 100, 110, 130 Aster 60, Explorer 60, 70, 80, 90, Frutteto 60, 75, Solar 60C, Vigneron 62, 75, Moteurs 1053P, 1000.3A, 1000.4A, 1000.6A <i>Engines</i> | 065.1225K (2x 065.1225.0) Larg. / Width : 29mm | 065.1216K (1x 065.1215.0 + 1x 065.1216.0) Larg. / Width : 26,25mm | 065.1218K (4x 065.1218.0) |

LAMBORGHINI

| Figures | 1 | 2 | 3 |
|---|--|---|---|
| Tracteurs <i>Tractors</i> | Coussinets de bielle <i>Conrod bearings</i> (Par cyl. / Per cyl.) | Coussinets de palier <i>Main bearings</i> (Par palier / Per hub) | Epaisseurs latérales <i>Thrust washers</i> (Par mot. / Per engine) |
| R235, C362, C453, C533, C553, R503, R603, R653, C653, R654, R754, R784, R854, R955, R1156, R1356, R1556 | 062.1225K (2x 062.1225.0) Larg. / Width : 27mm | 073.1215K (2x 029.1215.0) Larg. / Width : 32mm | 042.1218K (2x 042.1218.0 + 2x 042.1219.0) |

Coussinets & épaisseurs latérales disponibles en côte réparation.
Bearings and thrust washers are available in oversize.

Les références des pièces sont indicatives.
Nos pièces ne sont pas d'origine.

Part numbers are quoted for reference purposes only.
Our parts and accessories are not original.



JOINTS & COUSSINETS DE MOTEUR (REFROIDISSEMENT PAR EAU)
ENGINE GASKET & BEARINGS SETS (WATER COOLING)

LAMBORGHINI

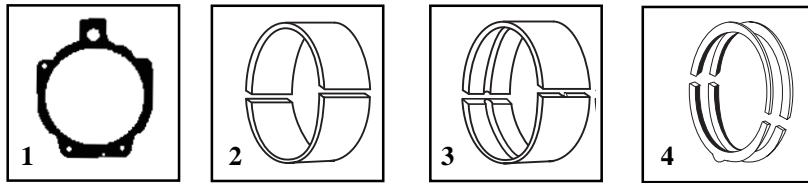

| Figures | | 1 | 2 | 3 | 4 |
|--|--------------------------------------|--|--|---|---|
| Tracteurs Tractors | Pochette complète Full gasket set | Joint de culasse Cyl. head gasket (Par cyl. / Per cyl.) | Coussinets de bielle Conrod bearings (Par cyl. / Per cyl.) | Coussinets de palier Main bearings (Par palier / Per hub) | Epaisseurs latérales Thrust washers (Par mot. / Per engine) |
| R.674, R.674.5, C.674, R.774, C.774, 774-5 (4 cyl.) | 066.0050.6 (A) | 078.1451.0 Languette sans trou Strip less hole Ep./Thick. : 1,2mm | | | |
| R.956, R.956-100, R.1106, R.1306 (6 cyl.) | 078.0050.6 (A) | | | | |
| R.674-70, R.674-70N, C.674-70 Grand-Prix, R.774-80, R.774-80N, C.774-80, C.774-80 Grand-Prix, C.874-70T, C.874-90T Grand-Prix, L.105 (4 cyl.) | 089.0050.6 (A) | 078.1452.0 Languette avec 2 trous Strip with 2 holes Ep./Thick. : 1,4mm | 065.1225K (2x 065.1225.0) | 065.1216K (1x 065.1215.0 + 1x 065.1216.0) | 065.1218K (4x 065.1218.0) |
| L.115, Formula 115, L.135, Formula 135, 6135 Elite (6 cyl.) | 337.0050.6 (A) | 078.1453.0 Languette avec 1 trou Strip with 1 hole Ep./Thick. : 1,6mm | | | |
| R.1506, R.1706 (6 cyl.) | 064.0050.6 (B) | 057.1456.0 | 062.1225K (2x 062.1225.0) | 073.1215K (2x 029.1215.0) | 042.1218K (2x 042.1218.0 + 2x 042.1219.0) |

HÜRLIMANN

| Figures | | 1 | 2 | 3 | 4 |
|--|--|--|--|---|---|
| Tracteurs Tractors | Pochette complète Full gasket set | Joint de culasse Cyl. head gasket (Par cyl. / Per cyl.) | Coussinets de bielle Conrod bearings (Par cyl. / Per cyl.) | Coussinets de palier Main bearings (Par palier / Per hub) | Epaisseurs latérales Thrust washers (Par mot. / Per engine) |
| H.466, H.476, H.486 (4 cyl.) | 066.0050.6 (A) | 078.1451.0 Languette sans trou Strip less hole Ep. /Thick. : 1,2mm | | | |
| H.468, H.468.4, H.468 Prestige, H.476F, H.478, H.478 Prestige, H.488T, H.488 Prestige, H.775F, H.775V (4 cyl.) | 089.0050.6 (A) | | | | |
| H.6115 Elite H.6135 Elite, H.6165 (6 cyl.) | 337.0050.6 (A) | 078.1453.0 Languette avec 1 trou Strip with 1 hole Ep. /Thick. : 1,6mm | | | |
| H.360 (3 cyl.) | | 057.1456.0 | | 073.1215K (2x 029.1215.0) | 042.1218K (2x 042.1218.0 + 2x 042.1219.0) |
| H.470, H.480 (4 cyl.) | SLT.714/14254 (B) | | | | |
| H.6130, H.6136, H.6160T, H.6170 (6 cyl.) | 064.0050.6 (B) (057.0050.6) | | | | |
| H.490T, H.496T (4 cyl.) | SLT.714/14254 (B) (059.0050.6) | | | | |
| H.5110T, H.5116T (5 cyl.) | 058.0050.6 (B) | | | | |

Coussinets & épaisseurs latérales disponibles en côte réparation. / Bearings and thrust washers are available in oversize.

(A) Sans joint de culasse / Less cyl. head gasket

(B) Avec joint de culasse / With cyl. head gasket

Les références des pièces sont indicatives.

Nos pièces ne sont pas d'origine.

Part numbers are quoted for reference purposes only.

Our parts and accessories are not original.



PISTONS, JEUX DE SEGMENTS & CYLINDRES (REFROIDISSEMENT PAR AIR)
PISTONS, RING SETS & CYLINDERS (AIR COOLING)

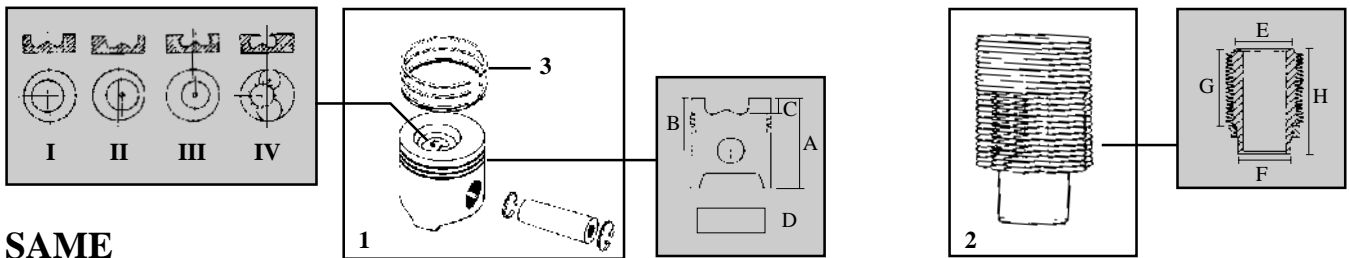

SAME

| Figures | | | 1 | 2 | 3 |
|--|-----------------|--------------|--|--|---|
| Tracteurs Tractors | Alésage Bore | Fig. Fig. | Pistons & segments Pistons & ring set | Cylindre Cylinder | Jeu de segments Ring set |
| Atlanta, Centauro, Delfino Minitauro (Mot. 953 Engine) | 95 | | | | S.021/00526 (5 segments 5 rings set) |
| Sirenetta, Delfino 35, Aurora 45, Corsaro 70 Drago, Falcon Vigneron (Mot. 982, 983, 984, 986/L Engine) Solar 50 | 98 | IV | S.303900 Ø Chambre Ø Chamber 55mm | S.103900 | E : 115 F : 117 G : 158 H : 223 |
| Panther (Mot. 985/041 Engine), Drago | | | S.304350 Ø Chambre Ø Chamber 46,5mm | | |
| Tiger Six 105, Panther 90, Corsaro 70SY Condor 55SY (Mot. 983, 984, 985, P-986P Engine) | | III | S.305000 | S.105000 | E : 118,5 F : 114 G : 152 H : 217,5 |
| Italia 35, Leone 70 (Mot. 1002V, 1004V Engine) | 100 | IV | S.303340 | S.103340 | E : 115 F : 112 G : 148 H : 231 |
| Tiger Six (Mot. 1006P Engine), Condor, Solar C55, C554, (Mot. 1003P Engine), Corsaro 70 Synchro, Vigneron 70 (Mot.1004P Engine), Laser 110 (Mot.1006P Engine) | | II | S.304840 (Std./Std.) S.304843 (Ø + 0,5) | A : 119 B : 69 C : -21,80 D : 35x80 | S.104840 |
| Explorer 55 (Mot. 916.3.A Engine), Explorer 65/65C/65SP, Explorer 75C/75Exp./75SP (Mot. 916.4.A Engine) | 103 | III | S.304194 | S.104194 | E : 116 F : 112,8 G : 72 H : 194,5 |
| Drago 120, Tiger 100, Leopard 85, Buffalo 130, Laser 100, Laser 130, Saturno 80SY, Trident 130, Centurion 75, Jaguar 95, Panther 95, Taurus (Mot. 1054, 1055, 1056/P Engine), Minitaurus, Mercury 85 | 105*120 | I | S.304600 (Std./Std.) S.460/05 (Ø + 0,5) | S.104600 | E : 118,5 F : 114 G : 152 H : 217,5 |
| Minitauro 60, Buffalo 120, Saturno 80 (Mot. 1052, 1053, 1054, 1055, 1056/L Engine) | | IV | S.304180 (Std./Std.) S.418/05 (Ø + 0,5) | | |
| Leopard 90, Laser 90 (Mot. 1054PT Engine) Hercules 160, Galaxy 170, Laser 150T (Mot. 1056PT Engine) (1979 ⇄) | 105*120 | III | S.304136 (Std./Std.) S.413/05 (Ø + 0,5) | S.104136 ou/ou S.104600 | E : 124 F : 114 G : 152 H : 217,5 |

Pistons & segments disponibles en côte réparation +0.5 & +1.0. / Pistons & ring sets are available in oversize + 0.5 & 1.0.

Les références des pièces sont indicatives.
Nos pièces ne sont pas d'origine.

Part numbers are quoted for reference purposes only.
Our parts and accessories are not original.



PISTONS, JEUX DE SEGMENTS & CYLINDRES (REFROIDISSEMENT PAR AIR)
PISTONS, RING SETS & CYLINDERS (AIR COOLING)

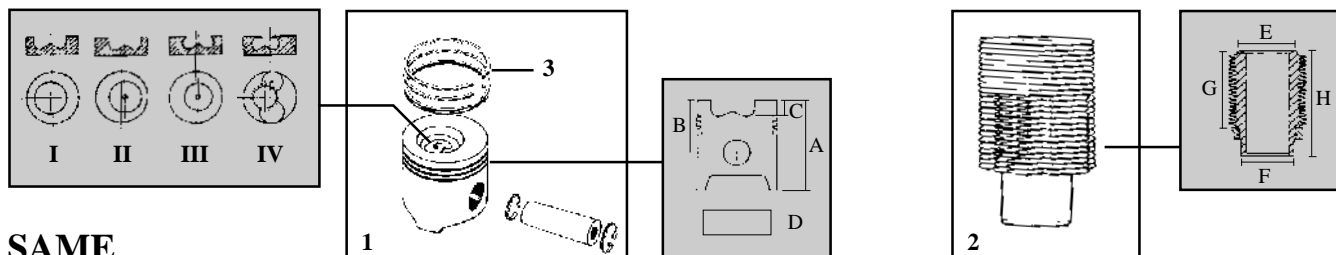

SAME

| Figures | | | 1 | 2 | 3 | |
|---|-----------------|--------------|---|----------------------------------|---|---|
| Tracteurs Tractors | Alésage Bore | Fig. Fig. | Pistons & segments Pistons & ring set | Cylindre Cylinder | Jeu de segments Ring set | |
| Aster 60, Explorer 60/60SP/60II, Frutetto 60 Vigneron 62 (Mot. 1000-3A Engine) Explorer 70/70SP/70II/70C, Antares 110 Frutetto 75, Explorer 80SP/80II/80C (Mot. 1000-4A/4A1 Engine) | 105*115,5 | II | 086.0060.6 | S.104239 (0851120) ⇨ 26012 | E : 116 F : 114,8 G : 72,5 H : 194,5 | 086.0052.6 (3 segments/3 rings set) |
| Antares 130 Silver 80, 90 Explorer II 90 (Mot. 1000-4AT Engine) | | | 338.0060.6 Renforcé Heavy duty | | | |
| JOINT DE CYLINDRE CYLINDER GASKET | | | Cylindre/Cylinder | | Réf./Ref. | Dimensions |
| | | | S.104239 | | 2.1519.096.0 | 107,65x1,78 |
| | | | S.070762 | | 2.1539.130.0 | 117,07x3,53 |

LAMBORGHINI - HÜRLIMANN

| Figures | | | 1 | 2 | 3 | | |
|---|-----------------|--------------|--|---|-----------------------------|---|--|
| Tracteurs Tractors | Alésage Bore | Fig. Fig. | Pistons & segments Pistons & ring set | Cylindre Cylinder | Jeu de segments Ring set | | |
| Lamborghini 235S, R.500, R.550, 654 C.362, C.453, C.533, C.352 Hürlimann H.351, Mot. 982L, 983L Engine | 98 | IV | S.303900 (Std./Std.) | A : 120 B : 70 C : -22,5 D : 35x80 | S.103900 | E : 115 F : 117 G : 158 H : 223 | S.034/00526 (4 segments 4 rings set) |
| Lamborghini R.1056, R.754, R.654, R.550, R.483 R.1156 | | | | | | | |
| Lamborghini R.653, 784, 854, 955, 1256 R.754, C.754, R.1156, R.1056, R.1256, C.653 Hürlimann H361 | 105*120 | I | S.304600 (Std./Std.) S.460/05 (Ø + 0,5) | A : 119 B : 69 C : -21,80 D : 35x90 | S.104600 | E : 118,5 F : 114 G : 152 H : 217,5 | S.038/00526 (4 segments 4 rings set) |
| Lamborghini R.573-60N, R.574-60N, 600, 660F, 660V (Mot. 1000-3A Engine) Hürlimann H306XE, H362, H361V, H361F, H361XF | 105*115,5 | II | S.304239 (Std./Std.) | A : 97,25 B : 57,25 C : -19,55 D : 35x86 | S.104239 | E : 116 F : 114,8 G : 72,5 H : 194,5 | S.014/13952 (3 segments 3 rings set) |

Les références des pièces sont indicatives.
Nos pièces ne sont pas d'origine.

Part numbers are quoted for reference purposes only.
Our parts and accessories are not original.



PISTONS, JEUX DE SEGMENTS & CHEMISES (REFROIDISSEMENT PAR EAU)
PISTONS, RING SETS & LINERS (WATER COOLING)

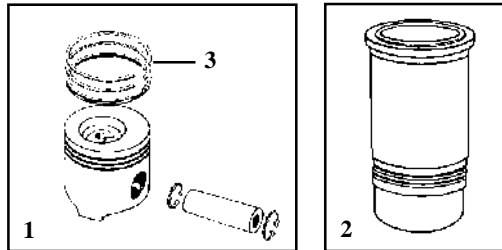

LAMBORGHINI

| Figures | | | 1 | 2 | 3 |
|---|-------------------------------|-----------------|--|---|---|
| Tracteurs Tractors | Type de moteur Engine type | Alésage Bore | Piston et segments Piston & ring set | Chemise (Sans joints) Liner (Less gaskets) | Jeu de segments Ring set |
| R.674, R.674.5, C.674 | 916.4W (4 cyl.) | 103 | SLT.714/13301 (066.0060.6, 069.00600.6) Axe / Pin : 32x77mm | SLT.714/13302 (066.1120.0) | SLT.714/14252 (065.0052.6) (3 segments 3 rings set) |
| R.774, C.774, 774-5 | 916.4W/1 (4 cyl.) | | | | |
| R.956, R.956-100 | 916.6W/1 (6 cyl.) | | | | |
| R.1106 | 916.6W/2 (6 cyl.) | | | | |
| R.1306 | 916.6WT (6 cyl.) | | 078.0060.6 Axe / Pin : 35x86mm | | |
| R.674-70, R.674-70N, C.674-70 Grand-Prix | 1000.4W (4 cyl.) | 105 | 086.0060.6 Axe / Pin : 35x86mm | 088.1120.0 | 086.0052.6 (3 segments 3 rings set) |
| R.774-80, R.774-80N, C.774-80, C.774-80 Grand-Prix | 1000.4W1 (4 cyl.) | | | | |
| C.874-70T, C.874-90T Grand-Prix | 1000.4WT (4 cyl.) | | | | |
| L.105 | 1000.4WTI (4 cyl.) | | | | |
| L.115, Formula 115 | 1000.6W1 (6 cyl.) | | 086.0060.6 Axe / Pin : 35x86mm | | 086.0052.6 (3 segments 3 rings set) |
| L.135, Formula 135 | 1000.6WTI (6 cyl.) | | 087.0060.6 Axe / Pin : 35x86mm | | 081.0090.6 (3 segments 3 rings set) |
| R.1506 | 1106/14T (6 cyl.) | 110 | 064.0060.6 Axe / Pin : 40x93mm | 057.1120.0 | 057.0051.6 (3 segments 3 rings set) |
| R.1706 | 1106/17T (6 cyl.) | | | | |

Les références des pièces sont indicatives.
Nos pièces ne sont pas d'origine.

Part numbers are quoted for reference purposes only.
Our parts and accessories are not original.



PISTONS, JEUX DE SEGMENTS & CHEMISES (REFROIDISSEMENT PAR EAU)
PISTONS, RING SETS & LINERS (WATER COOLING)

HÜRLIMANN

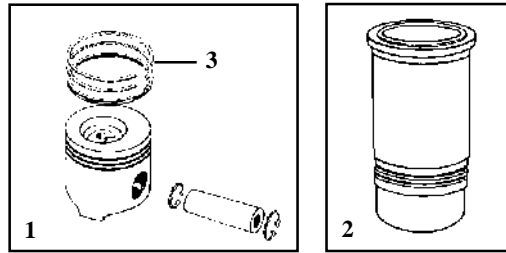

| Figures | | | 1 | 2 | 3 |
|---|-------------------------------|-----------------|--|---|---|
| Tracteurs Tractors | Type de moteur Engine type | Alésage Bore | Piston et segments Piston & ring set | Chemise (Sans joints) Liner (Less gaskets) | Jeu de segments Ring set |
| H.356 | 916.3W | 103 | SLT.714/13301 (066.0060.6, 069.00600.6) Axe / Pin : 32x77mm | SLT.714/13302 (066.1120.0) | SLT.714/14252 (065.0052.6) (3 segments 3 rings set) |
| H.466, H.476 | 916.4W (4 cyl.) | | 078.0060.6 Axe / Pin : 35x86mm | | |
| H.486 | 916.4WT (4 cyl.) | | | | |
| H.468, H.468.4, H.468 Prestige, H.476F, H.775F, H.775V | 1000.4W (4 cyl.) | 105 | 086.0060.6 Axe / Pin : 35x86mm | 088.1120.0 | 086.0052.6 (3 segments 3 rings set) |
| H.478, H.478 Prestige | 1000.4W1 (4 cyl.) | | | | |
| H.488T, H.488 Prestige | 1000.4WT (4 cyl.) | | 087.0060.6 Axe / Pin : 35x86mm | | |
| H.6115 Elite | 1000.6W1 (6 cyl.) | | 086.0060.6 Axe / Pin : 35x86mm | | |
| H.6135 Elite | 1000.6WTI (6 cyl.) | | 087.0060.6 Axe / Pin : 35x86mm | | |
| H.360 | 1103/5 (3 cyl.) | 110 | 058.0060.06 Axe / Pin : 35x82mm | 057.1120.0 | 057.0051.6 (3 segments 3 rings set) |
| H.470 | 1104/6 (4 cyl.) | | | | |
| H.480 | 1104/7 (4 cyl.) | | | | |
| H.6130 | 1106/12 (6 cyl.) | | | | |
| H.6136 | 1106/13 (6 cyl.) | | | | |
| H.6160T | 1106/15 (6 cyl.) | | | | |
| H.490T, H.496T | 1104/8T (4 cyl.) | | 064.0060.6 Axe / Pin : 40x93mm | | |
| H.5110T | 1105/10T (5 cyl.) | | | | |
| H.5116T | 1105/11T (5 cyl.) | | | | |
| H.6170 | 1106/17T (6 cyl.) | | | | |

Les références des pièces sont indicatives.
Nos pièces ne sont pas d'origine.

Part numbers are quoted for reference purposes only.
Our parts and accessories are not original.



JOINTS DE MOTEUR (REFROIDISSEMENT PAR AIR)
ENGINE GASKET SETS (AIR COOLING)

SAME

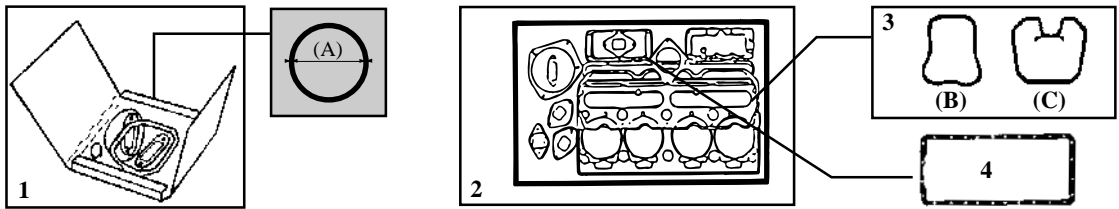

| Figures | 1 | 2 | 3 | 4 | |
|---|--|--------------------------------------|---|-----------------------------------|--------------------|
| Tracteurs Tractors | Pochette rodage Top gasket set (Par cyl. / Per cyl.) | Pochette complète Full gasket set | Joint cache-soupapes Rocker cover gasket | Joint de carter Sump gasket | |
| Delfino 35, Fox 35, Vigneron (2 cyl.) | S.034/0057D (A) 99x114mm | 29/A.31321 (034.0050.6) | S.029/1450 (B) | S.027/1512A | |
| Aurora 45, Fox 45/55, Vigneron 45 (3 cyl.) | | 29/A.31320 (035.0050.6) | | S.029/1512B | |
| Condor 55 Syn., Minitaurus 60 Syn., Taurus 60 (3 cyl.) | S.054/0057G (A) 106x118mm | 29/A.31327 (054.0050.6) | | S.029/1455A (C) | S.00/54046 |
| Explorer 65, 75, 85 (Mot.916 A/A Engine, 4 cyl.) | S.065/0057K (A) 104x114mm | 29/A.31328 (065.0050.6) | S.029/1450 (B) | | S.036/1512C |
| Centauro 70, Corsaro 70, Tiger Six Exp. (Mot. 984L Engine, 4 cyl.) | S.047/0057F (A) 103x117mm | 29/A.31322 (045.0050.6) | | | |
| Centurion 75 Exp., Leopard 85 Exp., Mercury 85 Exp., Saturno 80 Syn. (Mot. 1054 Engine, 4 cyl.) | S.042/0057H (A) 106x118mm | 29/A.31323 (044.0050.6) | S.00/54043 | | |
| Centauro 75, Laser 90 (Mot. 1054 Engine, 4 cyl.) | S.080/0057N (A) 106x118mm | 29/A.31329 | | | S.00/54043 |
| Jaguar 95 Exp., Panther 95, Laser 100, Tiger 100 (Mot. 1055 Engine, 5 cyl.) | S.042/0057H (A) 106x118mm | 29/A.31326 (042.0050.6) | S.00/54043 | | |
| Laser 110 (Mot. 1006/PA Engine, 6 cyl.) Tiger Six 105 | S.072/0057L (A) 104x117mm | 29/A.31330 (072.0050.6) | | | S.00/54043 |
| Laser 130 (Mot. 1056/PA Engine, 6 cyl.) | S.073/0057M (A) 106x118mm | 29/A.31331 (073.0050.6) | S.00/54043 | | |
| Buffalo 130, Drago 120, Trident 130 (Mot. 1056/P Engine, 6 cyl.) | S.042/0057 (A) 106x118mm | 29/A.32083 | | | S.00/54043 |
| Hercules 160 | S.052/00576 (A) 106x118mm | S.052/00506 | S.00/54043 | | |
| Laser 150, Galaxy 170 | S.071/00576 (A) 107x124x2,5mm | S.071/00506 | | S.00/54043 | |
| Sametto, Italia 32, Atlanta 42, Centauro 55 | S.021/0057A (A) 97x108mm | | S.00/54043 | | |
| Sirenetta, Delfino 32, Minitauro 46, 50, 55 | S.029/0057C (A) 97x110mm | | | S.00/54043 | |
| Panther 88 | S.041/0057E (A) 99x114mm | | S.00/54043 | | |
| Italia 35, Sametto, Leone, Atlanta 45 | S.024/0057B (A) 102x114mm | | | S.00/54043 | |
| Minitauro 60, Saturno 80, Buffalo 120 | S.038/0057K (A) 107x121mm | | S.00/54043 | | |

Les références des pièces sont indicatives.
Nos pièces ne sont pas d'origine.

Part numbers are quoted for reference purposes only.
Our parts and accessories are not original.



JOINTS DE MOTEUR (REFROIDISSEMENT PAR AIR)
ENGINE GASKET SETS (AIR COOLING)

LAMBORGHINI

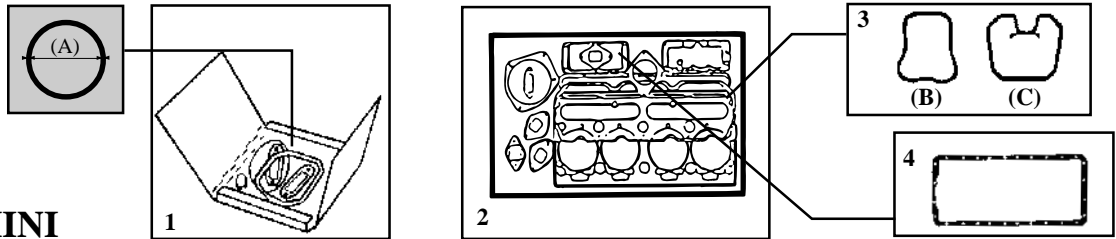

| Figures | 1 | 2 | 3 | 4 |
|--------------------------------|--|--------------------------------------|---|--------------------------------|
| Tracteurs Tractors | Pochette rodage Top gasket set (Par cyl. / Per cyl.) | Pochette complète Full gasket set | Joint cache-soupapes Rocker cover gasket | Joint de carter Sump gasket |
| R.235, R.235DT, C.352 (2 cyl.) | S.034/0057D 99x114mm (A) | 29/A.31321 (034.0050.6) | S.029/1450 (B) | S.027/1512A |
| R.653, C.653 (3 cyl.) | S.054/0057G 106x118mm (A) | 29/A.31327 (054.0050.6) | | S.029/1512B |
| R.654, R.754 (4 cyl.) | S.047/0057F 103x117mm (A) | 29/A.31322 (045.0050.6) | | S.036/1512C |
| R.784, R.784DT (4 cyl.) | S.072/0057L 104x117mm (A) | | | |
| 754, 754DT, 854DT (4 cyl.) | S.042/0057H 106x118mm (A) | 29/A.31323 (044.0050.6) | | |
| 955, 1055 (5 cyl.) | | 29/A.31326 (042.0050.6) | | S.041/1512D |

Les références des pièces sont indicatives.
Nos pièces ne sont pas d'origine.

Part numbers are quoted for reference purposes only.
Our parts and accessories are not original.



POMPES D'ALIMENTATION & KITS DE REPARATION
FUEL PUMPS & REPAIR KITS

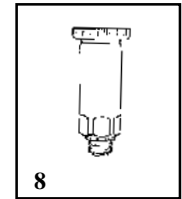
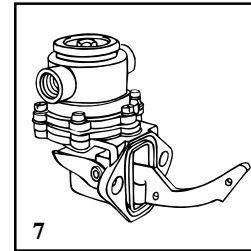
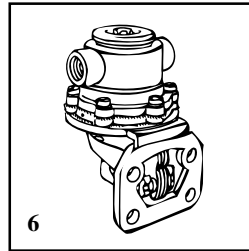
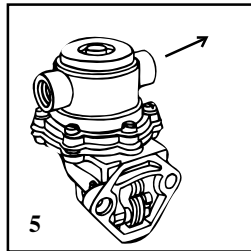
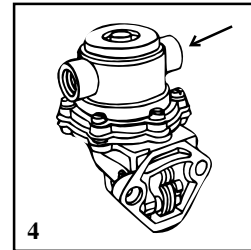
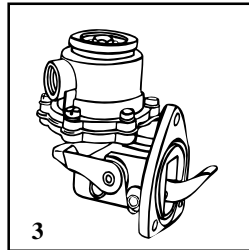
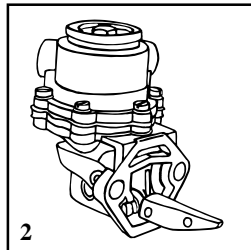
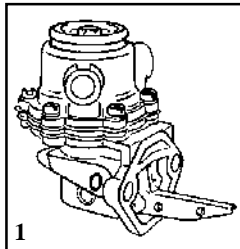

SAME

| Tracteurs Tractors | Fig. Fig. | Référence Reference | OEM | Kit réparation Repair kit | OEM |
|---|--------------|--|--|------------------------------|----------|
| Atlanta, Centauro, Leone | 1 | S.4519/010 Filet./Thread : 10x1 | 245190100 | S.390K | 24519139 |
| | 2 | S.4519/130 Filet./Thread : 14x,5 | 245191300 | S.390K | 24519239 |
| Samitalia, Sametto | 3 | S.4519/020 | | S.341K | 24519019 |
| Aurora, Corsaro, Centurion 75, Delfino Falcon, Minitauro, Saturno, Sirenetta | 4 | S.4519/100 | 00383196 245191600 245191900 | S.298K | 24519189 |
| Buffalo, Corsaro, Drago, Leopard Minitauro, Panther, Saturno, Tiger | 5 | S.4519/140 | 245191400 245191500 245191800 245192000 | S.400K | 24519129 |
| Buffalo 130, 140, Drago 120, Centurion, Condor, Corsaro 70, Jaguar 95, Mercury, Minitaurus, Panther 90, Saturno 80, Taurus, Tiger 100, 105, Leopard 85, 90 Laser 90, 100, 110, 130, 150 Minitauro 60 synchro | 6 | S.4519/230 | 245192200 245192300 245192900 | S.4519/239 | 24519239 |
| Antares 110, 130, Aster 60, Explorer, Silver, Titan, Frutteto 60 | 7 | S.4519/280 | 245193000 | S.4519/269 | 24519269 |
| Drago | 8 | S.2212 | | | |
| 6 cylindres & industriels 6 cylinders & industrials | 7 | S.4519/310 | 245193100 | | |

Pour d'autres types de tracteurs, se référer aux figures de ce programme
For other models, check the pictures

Les références des pièces sont indicatives.
Nos pièces ne sont pas d'origine.

Part numbers are quoted for reference purposes only.
Our parts and accessories are not original.



POMPES D'ALIMENTATION & KITS DE REPARATION
FUEL PUMPS & REPAIR KITS

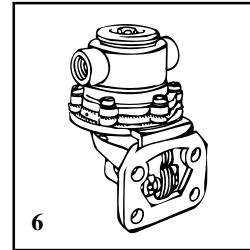
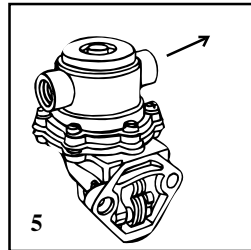
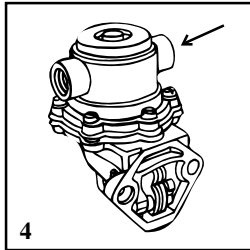
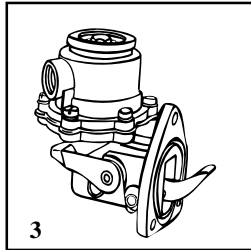

LAMBORGHINI

| Tracteurs Tractors | Fig. Fig. | Référence Reference | OEM | Kit réparation Repair kit | OEM |
|--------------------------------------|--------------|------------------------|--|------------------------------|----------|
| Anciens montages / Previous fittings | 3 | S.4519/020 | | S.341K | 24519019 |
| 553, 653, 753, 854, 654 | 4 | S.4519/100 | 00383196 245191600 245191900 | S.298K | 24519189 |
| R.1056 (⇄ 1979) | 5 | S.4519/140 | 245191400 245191500 245191800 245192000 | S.400K | 24519129 |
| 1056, 653, R.854, R.754 | 6 | S.4519/230 | 245192200 245192300 245192900 | S.4519/239 | 24519239 |

HÜRLIMANN

| Tracteurs Tractors | Fig. Fig. | Référence Reference | OEM | Kit de réparation Repair kit | OEM |
|-----------------------|--------------|------------------------|-------------------------------------|---------------------------------|----------|
| H.6160 | 6 | S.4519/230 | 245192200 245192300 245192900 | S.4519/239 | 24519239 |

Pour d'autres types de tracteurs, se référer aux figures de ce programme
For other models, check the pictures

Les références des pièces sont indicatives.
Nos pièces ne sont pas d'origine.

Part numbers are quoted for reference purposes only.
Our parts and accessories are not original.



BOUGIES DE PRECHAUFFAGE
HEATER PLUGS

SAME

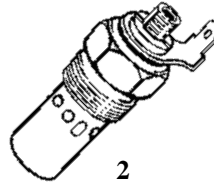
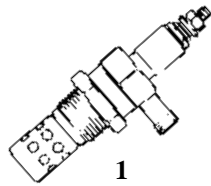

| Tracteurs Tractors | Fig. Fig. | Réf. Ref. | Filetage Thread | Volts Volts | Ampères Amperes |
|-------------------------------------|--------------|--------------|--------------------|----------------|--------------------|
| Equipement "BOSCH" <i>Equipment</i> | 1 | S.7659/013 | M20x1,5 | 9,5 | 22 |
| Equipement "CAV" <i>Equipment</i> | 2 | S.7659/007 | 1/2" BSP | 12 | 12,5 |

NEZ D'INJECTEURS
INJECTOR NOZZLES

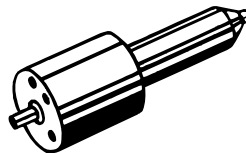

SAME

| Tracteurs Tractors | Référence Reference | N° sur injecteur N° on the nozzle |
|---|-----------------------------------|--------------------------------------|
| Buffalo 130, Centurion 70, Corsaro, Faleon, Condor 55, Delfino 35, Leopard, Jaguar, Laser 90 ⇄ 130, Minitauro, Minitaurus | 29/71095 (247290100) | 433271079 DLLA160S255 |
| Drago 100, Saturno, Buffalo 120, Corsaro | 29/71233 (247290500) | DLLA160S608 |
| Laser 150, Galaxy 170, Hercules 160 | 29/4729-090 (247290900) | DLLA150S830 |
| Explorer 60, 70, 75, 80, 90, Aster 60, Frutteto 60, 75, Vigneron 62, 75, Antares 110, 130, Silver | 29/4729-100 (247291000) | DDLA150S925 DLLA150S690 |

LAMBORGHINI

| | | |
|---|-----------------------------------|----------------------------|
| R.235, 653, 854, 754, 455, 1056DT, 1256DT | 29/71095 (247290100) | 433271079 DLLA160S255 |
| 674-70, 874-90, 774-80, 600, 700, 1106, 1306, 105, 775F | 29/4729-100 (247291000) | DDLA150S925 DLLA150S690 |

HÜRLIMANN

| | | |
|--|--------------------------------|----------------------------|
| Selon applications <i>Some applications</i> | 29/71199 (247290800) | 433271855 DLLA150S806 |
| H.351, H.361 | 29/71095 (247290100) | 433271079 DLLA160S255 |
| H.358, 362, 468, 478, 488T, 4105 | 29/4729-100 | DDLA150S925 DLLA150S690 |

Les références des pièces sont indicatives.
Nos pièces ne sont pas d'origine.

Part numbers are quoted for reference purposes only.
Our parts and accessories are not original.



POMPES A EAU
WATER PUMPS

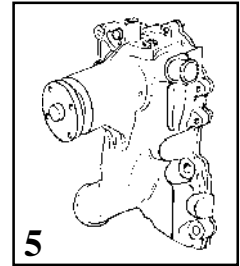
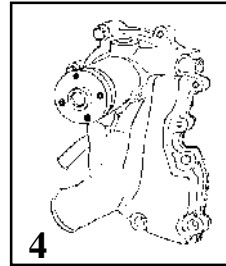
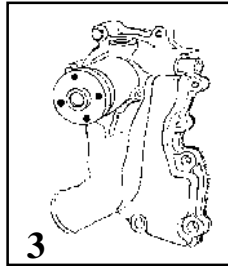
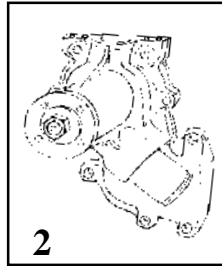
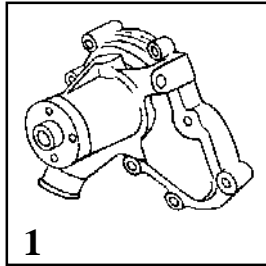

SAME

| Tracteurs Tractors | Fig. Fig. | OEM | Pompe Pump |
|-----------------------|--------------|---------------------------------------|---|
| Silver 80, 90, 100.4 | 1 | 08217404 / 10-20-30-40-50 08217406 | 082.1740.450 (B) 3 sorties + Trou fileté 3 outlets + threaded hole |
| Titan 145, 160, 190 | 2 | 0641740620 | 064.1740.620 (B) |
| Silver 100.6 | 3 | 0751740450 07517404/60 | 075.1740.450 (B) |
| Antares II, 110, 130 | 4 | 0781740450 07817404/60 | 078.1740.450 (B) |

LAMBORGHINI

| Tracteurs Tractors | Fig. Fig. | OEM | Pompe Pump |
|--|--------------|--|---|
| 674, 674.70, 674.70GP, 774.5 Sprint 664.60, 664.70, 774.80 Cross 574.60, 674.70 Plus 660, 775, 880, 990 Vigneto 660, 775 | 1 | 06617404 / 10-20-30-40-50-60 00970396 | 066.1740.460 (B) 2 sorties / 2 outlets |
| 774.80, 774.80GP, 775, 874.90, 874.90GP Premium 850, 950, 1050 Formula 105 | | 08217404 / 10-20-30-40-50 08217406 | 082.1740.450 (B) 3 sorties + Trou fileté 3 outlets + threaded hole |
| 874-90 avec airco / With airco | | 08217564 | 082.1756.4 (B) 4 sorties / 4 outlets |
| 1106, 1306, 1356, 1556, 1506, 1706 Racing 150, 165, 190 | 2 | 0641740620 | 064.1740.620 (B) |
| 956, 1306, 1060 Formula 115, 135 | 3 | 0751740450 07517404/60 | 075.1740.450 (B) |
| 1106, 1306 | 4 | 0781740450 07817404/60 | 078.1740.450 (B) |
| Formula 115-135, Premium 1060, Racing 150, 165, 190 | 5 | 00705954/30 01011384/20 | 010.1138.4 (B) |

(B) Sans poulie / Less pulley

Les références des pièces sont indicatives.
Nos pièces ne sont pas d'origine.

Part numbers are quoted for reference purposes only.
Our parts and accessories are not original.



POMPES A EAU
WATER PUMPS

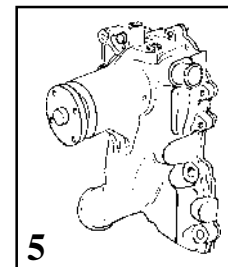
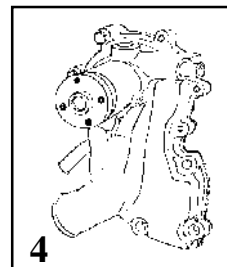
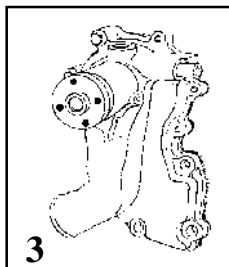
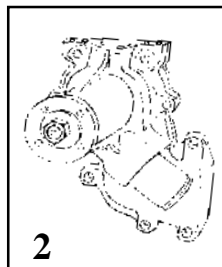
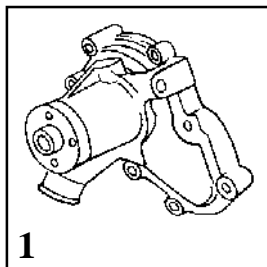

HÜRLIMANN

| Tracteurs Tractors | Fig. Fig. | OEM | Pompe Pump |
|--|--------------|--|---|
| H.356, H.358 | 1 | 06617404 / 10-20-30-40-50-60 00970396 | 066.1740.460 (B) 2 sorties / 2 outlets |
| Club H358.4, H468.4 | | 08217404 / 10-20-30-40-50 08217406 | 082.1740.450 (B) 3 sorties + Trou fileté 3 outlets + threaded hole |
| 488T, XA606, XA607, XT908, XT909, XT910.4 | | 08217564 08217406 | 082.1756.4 (B) 4 sorties / 4 outlets |
| 360, 470, 480, 490, 5110, 6130, H.5110T, 6136, 496T, 5116T, 6170T, 6165, 6190 | 2 | 0641740620 | 064.1740.620 (B) |
| Elite 6115, 6135, XT908, XT909, XT910.4 | 3 | 0751740450 07517404/60 | 075.1740.450 (B) |
| XT910.6 | 4 | 0781740450 07817404/60 | 078.1740.450 (B) |
| H.6115, H.6135 Elite, Master H.6165, 6190 | 5 | 00705954/30 01011384/20 | 010.1138.4 (B) |

(B) Sans poulie / Less pulley



COURROIES DE VENTILATEUR
FAN BELTS

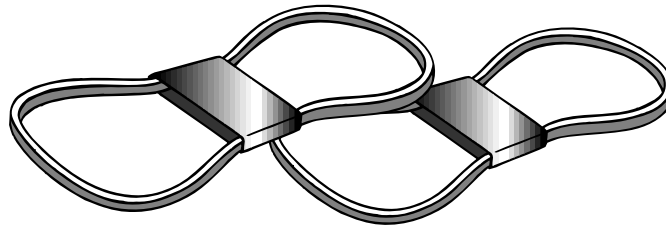

SAME

| Tracteurs <i>Tractors</i> | Réf. par pair <i>Ref. by pair</i> | OEM |
|---|--------------------------------------|--|
| Corsaro 70, Minitauro 60 | S.4119/001 2x(AVX10-1400) | 241190010, 241190360, 241190610 |
| Aurora, Delfino, Minitauro 50, Vigneron 35, 45, 50 Falcon, Solar 50, Saturno 80, Explorer 65, 70, 75, 80 | S.4119/007 2x(AVX10-1350) | 241190070, 241190510 244190740 |
| Buffalo 120, Drago 100 | S.4119/034 2x(AVX10-1525) | 241190340 |
| Buffalo 130, Jaguar 95, 100, Tiger 100, 105, Drago 120 Panther 90, Laser 110, 130 | S.4119/040 2x(AVX10-1550) | 241190400 241190860 |
| Centaurio 70, Leopard 85, 90, Mercury 85, Saturno 80, Centurion 75 | S.4119/053 2x(AVX10-1450) | 241190530, 241190420, 241190760 |
| Hercules 160, Panther 88, 95 Tiger 105 (⇔ 8469), Trident 130, Laser 100 | S.4119/054 2x(AVX10-1575) | 241190540, 241190390 241190500, 241190770 |
| Minitauro 55 | S.4119/066 2x(AVX10-1375) | 241190660, 241190120 |
| Corsaro 70, Condor 55, Minitaurus, Solar 60 Taurus 60, Vigneron 60 | S.4119/075 2x(AVX10-1425) | 241190750, 241190410 241190460, 241190520 |
| Titan 145, 160, Antares 110, 130 | S.4119/118 2x(AVX13-1450) | 041191180 |

LAMBORGHINI

| Tracteurs <i>Tractors</i> | Réf. <i>Ref.</i> |
|--|---------------------|
| 360, 360DT | AVX13-1325 |
| 483, 503, 503S, 503DT, 583, 603, 603DT | AVX10-1150 |
| 704, 704DT, 804, 804DT, 904, 904DT | AVX13-1275 |
| 550, 660, 654, 754, 784, 854 | AVX10-1475 |
| 674, 774, 874 | AVX10-1225 |
| 955, 1056, 1156, 1256 | AVX10-1500 |
| 1356, 1556 | AVX10-1625 |
| 653, 683, 684 | AVX10-1425 |
| 956 | AVX13-1300 |
| 1106 | AVX13-1425 |
| 1306 | AVX13-1350 |
| 1506, 1706 | AVX10-1575 |

HÜRLIMANN





| Tracteurs <i>Tractors</i> | Réf. <i>Ref.</i> |
|---|---------------------|
| H5110T, H5116T, H6130, H6136 6160 (⇔ 20400221) | AVX10-1625 |
| 6160 (20400222 ⇔), H6170T | AVX10-1575 |
| H345 | AVX10-1350 |
| H355F | AVX10-1425 |
| H356 mot. / engine 916.3 (⇔ 1110) | AVX10-1225 |
| H356 mot. / engine 916.3 (1111 ⇔) | AVX10-1200 |
| H466, H466-4, mot. / engine 916-4 | AVX10-1225 |
| H470, H480, H490 | AVX10-1400 |

Les références des pièces sont indicatives.
Nos pièces ne sont pas d'origine.

Part numbers are quoted for reference purposes only.
Our parts and accessories are not original.

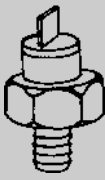

CONTACTEURS DIVERS
SWITCHES (MISCELLANEOUS)

| | | |
|-------------------------------------|---|---|
| S.7099/040 (70990100) | Huile (Fil. 10x1)(↔ 50ps) <i>Oil (Thread : 10x1)</i> |  |
| S.7099/1205 (70790400/10) | Huile (Fil. 12x1,75)(50ps ↔) <i>Oil (Thread : 12x1,75)</i> | |
| S.7099/180 (270991800) | Prise de force <i>PTO drive</i> | |
| S.7099/190 (270991900) | Hydraulique stop <i>Hydraulic stop</i> | |
| S.7099/320 (27099320) | Colmatage filtre à air <i>Plugging of air filter</i> | |
| 29/7659.008 (27659008) | Sécurité, ouvert, 2 plots <i>Safety, open, 2 plugs</i> |  |
| S.7659/021 (276590210/01) | Sécurité, ouvert, 4 plots <i>Safety, open, 4 plugs</i> | |
| S.7659/0140 (27659014/01) | Sécurité, fermé <i>Safety, closed</i> | |
| S.7659/05 (276590050) | Position/contact/démarrage 5 plots <i>Position/switch/starter</i> 5 plugs |  |
| S.7659/6 (276590060/01) | Préchauffage/contact/démarrage 7 plots <i>Heating/switch/starter</i> 7 plugs | |
| S.7659/12 (276590240) | Préchauffage/contact/démarrage 8 plots <i>Heating/switch/starter</i> 8 plugs | |
| S.7069/040 (270690400/01) | Contacteur de température <i>Temperature switch</i> Same Buffalo, Drago |  |

JAUGES DE RESERVOIR
SENDER UNIT

Types sans réserve / *Types less reserve*

- S.7059/800** Lg. : 390mm
- S.7059/130** Lg. : 455mm
- S.7059/100** Lg. : 295mm
- S.7059/120** Lg. : 428mm
- S.7059/022** Lg. : 480mm

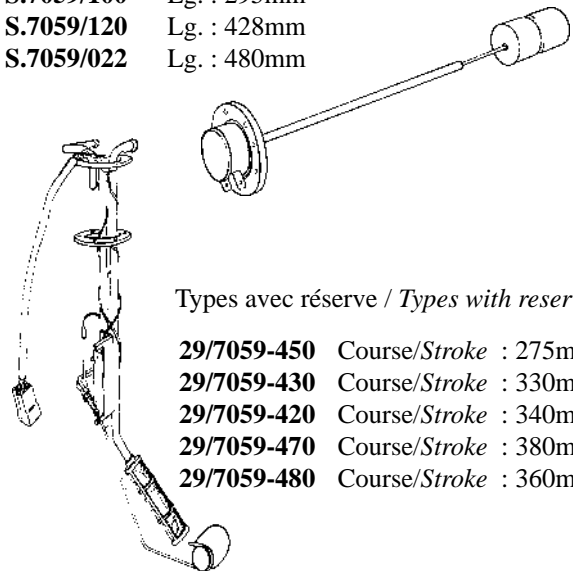

Types avec réserve / *Types with reserve*

- 29/7059-450** Course/Stroke : 275mm
- 29/7059-430** Course/Stroke : 330mm
- 29/7059-420** Course/Stroke : 340mm
- 29/7059-470** Course/Stroke : 380mm
- 29/7059-480** Course/Stroke : 360mm

Les références des pièces sont indicatives.
Nos pièces ne sont pas d'origine.

Part numbers are quoted for reference purposes only.
Our parts and accessories are not original.

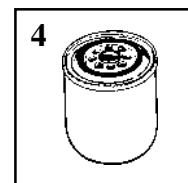
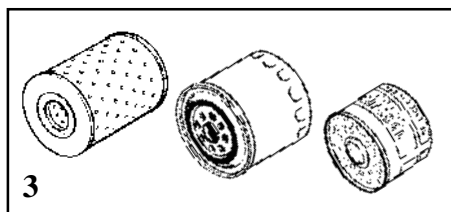
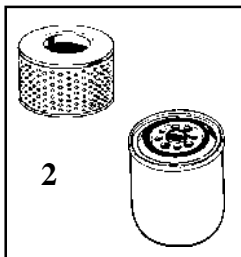
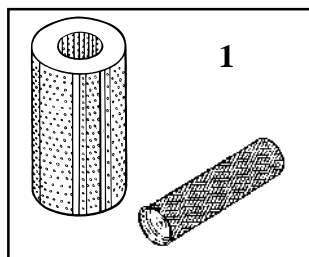

FILTRATION - SAME
FILTERS - SAME

| Tracteurs Tractors | 1 Air | | 2 Huile Oil | 3 Combustible Fuel | 4 Hydraulique Hydraulic |
|---|---|-------------------------------|--|---|---|
| | Ext. / Out. | Int. / Inn. | | | |
| Antares 100 Syncro | 60/161-104 (TFA.581) | 60/162-25 (2466) | 60/97-38 (309/F) | 60/111-4 (1193/F) (Repl. CAV 796) | 60/240-69 Ht.: 180mm Filet / Thread M40x2 ou / or 60/240-68 Ht.: 186mm Filet / Thread 1"1/8 |
| Antares 110 Moteur A6 110HP Engine | | | | | |
| Antares 130 Turbo Moteur AT 127HP Engine | | | | | |
| Atlanta, Samecar 42, Samecar 45 | | | 60/96-3 (102T) | 60/111-64 (F.1007) + 60/111-32 (1007) | |
| Argon 50, 60, Crono 50, 60 | | | 60/97-36 (294/F) | 60/111-25 (5006/F) (Repl. CAV 496) | |
| Argon 70, Crono 70 | 60/161-104 (TFA.581) | 60/162-25 (2466) | 60/97-22 (169) | 60/111-16 (1194/F) | |
| Ariete 137 | | | 60/96-19 (109) (Cartouche Cartridge) ou / or 60/97-4 (305/F) (A visser / Spin on) | 60/111-65 (F.1008) + 60/111-33 (1008) | |
| Aster 60 | 60/161-112 (TM.254) (Conique, vis centrale Conical type, central nut) | 60/162-112 (TM.255) | 60/97-36 (294/F) | 60/111-3 (1087/PK) (Repl. CAV 296) | 60/240-66 (SLT.4419/280) Ht.: 232mm Filet / Thread M40x2 |
| Aster 70 Turbo Moteur 1000-3AT Engine | 60/161-104 (TFA.581) | 60/162-25 (2466) | 60/97-22 (169) | | |
| Aurora 45 (2RM / WD), Aurora 45 (4RM / WD) Vigneto | 60/161-63 (2500) | 60/162-1 (568) | 60/97-2 (599AR/F) | | |

Les références des pièces sont indicatives.
Nos pièces ne sont pas d'origine.

Part numbers are quoted for reference purposes only.
Our parts and accessories are not original.



"THE RELIABLE SERVICE"



| Tracteurs Tractors | 1 | | 2 | 3 | 4 |
|--|---|-------------------------------|--|---|--|
| | Air | | Huile Oil | Combustible Fuel | Hydraulique Hydraulic |
| | Ext. / Out. | Int. / Inn. | | | |
| Buffalo 120 (2RM / WD), 120 (4RM / WD), 130 (4RM / WD) | 60/161-60 (2465) Couvercle / Cap Ø 155mm (↔ 9/81) | 60/162-25 (2466) | 60/97-40 (332/F) | 60/111-3 (1087/PK) (Repl. CAV 296) ou / or 60/111-4 (1193/F) (Repl. CAV 796) | |
| | 60/161-104 (TFA.581) Couvercle / Cap Ø 214mm (9/81 ↔) | 60/162-25 (2466) | | | |
| Buffalo 130, Buffalo 130 Export | 60/161-60 (2465) Couvercle / Cap Ø 200mm (↔ Série / Serie 5960) | 60/162-25 (2466) | 60/97-38 (309/F) | 60/111-4 (1193/F) (Repl. CAV 796) | |
| | 60/161-104 (TFA.581) Couvercle / Cap Ø 214mm (Série / Serie 5961 ↔) | 60/162-25 (2466) | | | |
| Centauro 60, Centauro 65 | 60/161-54 (2127) (Sans ailettes Less fins) | | 60/97-25 (370) (Filet / Thread 22x1,5) (↔ 15807) | 60/111-64 (F.1007) + 60/111-32 (1007) ou / or 60/111-3 (1087/PK) (Repl. CAV 296) | |
| | | | 60/96-3 (102T) (Cartouche Cartridge) ou / or 60/97-2 (599AR/F) (A visser / Spin on) | | |
| Centauro 70 Export | 60/161-112 (TM.254) | 60/162-112 (TM.255) | | | 60/240-67 (SLT.4419/320) Ht.: 264mm Filet / Thread M40x2 |
| Centauro 70 Syncro | 60/161-66 (7293) (Conique, 2 pattes Conical type, 2 fixings holes) (↔ 12/82) | 60/162-66 (7285) | 60/97-36 (294/F) | 60/111-3 (1087/PK) (Repl. CAV 296) | 60/240-66 (SLT.4419/280) Ht.: 232mm Filet / Thread M40x2 |
| | 60/161-112 (TM.254) (Conique, vis centrale Conical type, central nut) (1/83 ↔) | 60/162-112 (TM.255) | | | |

Les références des pièces sont indicatives.
Nos pièces ne sont pas d'origine.

Part numbers are quoted for reference purposes only.
Our parts and accessories are not original.



"THE RELIABLE SERVICE"



| Tracteurs Tractors | 1 | | 2 | 3 | 4 | |
|-----------------------------|--|---|----------------------------|---|--|--|
| | Air | | Huile Oil | Combustible Fuel | Hydraulique Hydraulic | |
| | Ext. / Out. | Int. / Inn. | | | | |
| Centurion 75 | 60/161-59 (2449) (↔ Série / Serie 2870) 60/161-66 (7293) (Conique, 2 pattes <i>Conical type,</i> 2 fixings holes) (Série / Serie 2871 ↔ 5000) 60/161-112 (TM.254) (Conique, vis centrale <i>Conical type,</i> central nut) (Série / Serie 5001 ↔) | 60/162-59 (2464) 60/162-66 (7285) 60/162-112 (TM.255) | 60/97-36 (294/F) | 60/111-3 (1087/PK) (Repl. CAV 296) | 60/240-67 (SLT.4419/320) Ht.: 264mm Filet / Thread M40x2 (↔ Série / Serie 5000) 60/240-66 (SLT.4419/280) Ht.: 232mm Filet / Thread M40x2 (Série / Serie 5001 ↔) | |
| Centurion 75 Export | 60/161-66 (7293) (Conique, 2 pattes <i>Conical type,</i> 2 fixings holes) (↔ 12/82) 60/161-112 (TM.254) (Conique, vis centrale <i>Conical type,</i> central nut) (1/83 ↔) | 60/162-66 (7285) 60/162-112 (TM.255) | | | | |
| Centurion 75 Special | 60/161-112 (TM.254) | 60/162-112 (TM.255) | | | | 60/240-66 (SLT.4419/280) Ht.: 232mm Filet / Thread M40x2 |
| Condor C | 60/161-8 (2543) | 60/162-8 (2544) | | | | |
| Condor 55, Condor 55 Syncro | 60/161-8 (2543) (↔ Série / Serie 12000) 60/161-112 (TM.254) (Conique, vis centrale <i>Conical type,</i> central nut) (Série / Serie 12001 ↔) | 60/162-8 (2544) 60/162-112 (TM.255) | | | | |

Les références des pièces sont indicatives.
 Nos pièces ne sont pas d'origine.

Part numbers are quoted for reference purposes only.
 Our parts and accessories are not original.



"THE RELIABLE SERVICE"



| Tracteurs Tractors | 1 | | 2 | 3 | 4 |
|--|--|-------------------------------|----------------------------|---|---|
| | Air | | Huile Oil | Combustible Fuel | Hydraulique Hydraulic |
| Ext. / Out. | Int. / Inn. | | | | |
| Corsaro 60, 70 (2RM / WD), 70 (4RM / WD) | 60/161-54 (2127) (Sans ailettes <i>Less fins</i>) (⇔ Série / Serie 10122) | | 60/97-36 (294/F) | | |
| | 60/161-62 (2498) (Série / Serie 10123 ⇔) | 60/162-62 (2499) | | | |
| | ou / or 60/161-112 (TM.254) (Conique, vis centrale <i>Conical type, central nut</i>) | 60/162-112 (TM.255) | | | |
| Corsaro 70 Syncro, DT | 60/161-62 (2498) | 60/162-62 (2499) | | | |
| Corsaro 70 Frutteto | 60/161-66 (7293) (Conique 2 pattes <i>Conical type 2 fixings holes</i>) (⇔ 12/82) | 60/162-66 (7285) | | 60/111-3 (1087/PK) (Repl. CAV 296) | 60/240-68 (SLT.4419/270) Ht.: 186mm Filet / Thread 1 1/8" |
| | 60/161-112 (TM.254) (Conique, vis centrale <i>Conical type, central nut</i>) (1/83 ⇔) | 60/162-112 (TM.255) | | | |
| Delfino 32 | 60/161-87 (2477) | | 60/96-24 (101/F) | | |
| Delfino 32 (2RM / WD), 32 (4RM / WD) Frutteto | | | | | |
| Delfino 32 Speciale | | | | | |
| Delfino 35 (4RM / WD), 35 (4RM / WD) Frutteto | 60/161-63 (2500) | 60/162-1 (568) | 60/97-4 (305/F) | | |
| Delfino 35 Deserto | 60/161-8 (2543) | 60/162-8 (2544) | | | |
| Dinosauro, Elefante TS/TS/W, TSA | | | 60/96-19 (109) | 60/111-65 (F.1008) + 60/111-33 (1008) | |

Les références des pièces sont indicatives.
Nos pièces ne sont pas d'origine.

Part numbers are quoted for reference purposes only.
Our parts and accessories are not original.



"THE RELIABLE SERVICE"



| Tracteurs Tractors | 1 | | 2 | 3 | 4 | | |
|--|--|--|---|--|--|--|--|
| | Air | | Huile Oil | Combustible Fuel | Hydraulique Hydraulic | | |
| | Ext. / Out. | Int. / Inn. | | | | | |
| Dorado 60 Moteur 1003A 60HP Engine | | | 60/97-36 (294/F) | 60/111-3 (1087/PK) (Repl. CAV 296) | 60/240-69 (SLT.4419/350) Ht.: 180mm Filet / Thread M40x2 | | |
| Dorado 70 Moteur 1004A 70HP Engine | | | | | | | |
| Drago 100 | 60/161-59 (2449) Ø 134mm (↔ Série / Serie 5347) 60/161-60 (2465) Ø 155mm (Série / Serie 5348 ↔) | 60/162-59 (2464) 60/162-25 (2466) | 60/97-40 (332/F) (↔ 12/75) 60/97-38 (309/F) (1/76 ↔) | | | | |
| Drago 120 | 60/161-60 (2465) Couvercle / Cap Ø 155mm (↔ Série / Serie 10604) 60/161-104 (TFA.581) Couvercle / Cap Ø 214mm (Série / Serie 10605 ↔) | 60/162-25 (2466) 60/162-25 (2466) | 60/97-38 (309/F) | 60/111-4 (1193/F) (Repl. CAV 796) | | | |
| Explorer 55, 65, 75 | 60/161-112 (TM.254) (Conique, vis centrale Conical type, central nut) | 60/162-112 (TM.255) | 60/97-36 (294/F) | 60/111-3 (1087/PK) (Repl. CAV 296) | 60/240-69 (SLT.4419/350) Ht.: 180mm Filet / Thread M40x2 | | |
| Explorer 55 Export, Explorer 65 Export, Special | | | | | | | |
| Explorer 60, Explorer 60 II, Explorer 60 Special, Explorer 75 | | | | | | | |
| Explorer 60 Frutteto, 75 Frutetto | | | | | | | |
| Explorer 60DT | | | | | | | |
| Explorer 65C Ergomatic, Explorer 70C Ergomatic, Explorer 75C Ergomatic | | | | | | | 60/240-67 (SLT.4419/320) Ht.: 264mm Filet / Thread M40x2 |
| Explorer 70, Explorer 70C Special, Explorer 70 II | | | | | | | |
| Explorer 70C, 80C, 90C | | | | | | | |
| Explorer 75, Export, Special, Explorer 85, Export, Special | | | | | | | 60/240-66 (SLT.4419/280) Ht.: 232mm Filet / Thread M40x2 |
| Explorer 80 II, Explorer 80 Special, Explorer 80 Special Basso, Explorer 80C Ergomatic | 60/161-104 (TFA.581) | 60/162-25 (2466) | | 60/240-69 (SLT.4419/350) Ht.: 180mm Filet / Thread M40x2 | | | |
| Explorer 90 Turbo, Explorer 90 II Turbo | | | 60/97-22 (169) | 60/111-4 (1193/F) (Repl. CAV 796) | | | |

Les références des pièces sont indicatives.
Nos pièces ne sont pas d'origine.

Part numbers are quoted for reference purposes only.
Our parts and accessories are not original.



"THE RELIABLE SERVICE"



| Tracteurs Tractors | 1 | | 2 | 3 | 4 |
|---------------------------------|--|--|--|---|--|
| | Air | | Huile Oil | Combustible Fuel | Hydraulique Hydraulic |
| | Ext. / Out. | Int. / Inn. | | | |
| Falcon C | 60/161-8 (2543) | 60/162-8 (2544) | 60/97-2 (599AR/F) (↔ 12/75) 60/97-36 (294/F) (1/76 ↔) | 60/111-3 (1087/PK) (Repl. CAV 296) | |
| Falcon (2RM / WD), (4RM / WD) | 60/161-63 (2500) Ht.: 235mm (↔ Série / Serie 7209) 60/161-8 (2543) Ht.: 315mm (Série / Serie 7210 ↔) | 60/162-1 (568) 60/162-8 (2544) | 60/97-2 (599AR/F) | | |
| Falcon CC, Falcon CL, Falcon CN | 60/161-8 (2543) | 60/162-8 (2544) | | | |
| Falcon 50 | | | | | |
| Fox 35, Fox 45, Fox 55 | | | 60/97-4 (305/F) | | |
| Frutteto 60 | | | 60/97-36 (294/F) | | 60/240-69 (SLT.4419/350) Ht.: 180mm Filet / Thread M40x2 |
| Galaxy 170, Galaxy 170 Turbo | | | | 60/111-4 (1193/F) (Repl. CAV 796) | 60/240-65 (SLT.4419/260) Ht.: 211mm Filet / Thread 1" |
| Hercules 160 Export | 60/161-64 (2553) | 60/162-64 (TFA.734) | 60/97-21 (121) | | |
| Italia V, VDT, Italia 35 | | | 60/96-24 (101/F) | 60/111-28 (1009) (↔ Série / Serie 6495) 60/111-3 (1087/PK) (Repl. CAV 296) (Série / Serie 6496 ↔) | |
| Jaguar 95 | 60/161-60 (2465) Couvercle / Cap Ø 155mm (↔ 8/81) 60/161-104 (TFA.581) Couvercle / Cap Ø 214mm (9/81 ↔) | 60/162-25 (2466) 60/162-25 (2466) | 60/97-38 (309/F) | 60/111-4 (1193/F) (Repl. CAV 796) | |
| Jaguar 95 Export | 60/161-104 (TFA.581) | 60/162-25 (2466) | | | 60/240-65 (SLT.4419/260) Ht.: 211mm Filet / Thread 1" |

Les références des pièces sont indicatives.
Nos pièces ne sont pas d'origine.

Part numbers are quoted for reference purposes only.
Our parts and accessories are not original.



"THE RELIABLE SERVICE"



| Tracteurs Tractors | 1 | | 2 | 3 | 4 |
|--|---|-------------------------------|--|---|--|
| | Air | | Huile Oil | Combustible Fuel | Hydraulique Hydraulic |
| | Ext. / Out. | Int. / Inn. | | | |
| Laser 90 | 60/161-104 (TFA.581) | 60/162-25 (2466) | 60/97-22 (169) | 60/111-4 (1193/F) (Repl. CAV 796) | 60/240-66 (SLT.4419/280) Ht.: 232mm Filet / Thread M40x2 |
| Laser 100, Laser 110, Laser 130 | | | 60/97-38 (309/F) | | |
| Laser 150, Laser 150 Turbo | 60/161-64 (2553) | 60/162-64 (TFA.734) | 60/97-21 (121) | | |
| Leopard C | | | 60/97-36 (294/F) | 60/111-3 (1087/PK) (Repl. CAV 296) | 60/240-69 (SLT.4419/350) Ht.: 180mm Filet / Thread M40x2 |
| Leopard 85, Leopard 85 Export | 60/161-59 (2449) | 60/162-59 (2464) | | | |
| Leopard 90 Turbo | 60/161-104 (TFA.581) | 60/162-25 (2466) | 60/97-22 (169) | 60/111-4 (1193/F) (Repl. CAV 796) | 60/240-65 (SLT.4419/260) Ht.: 211mm Filet / Thread 1" |
| Mercury 85 Export, Mercury 85 Special | 60/161-66 (7293) (Conique, 2 pattes Conical type, 2 fixings holes) (↔ 12/82) | 60/162-66 (7285) | 60/97-36 (294/F) | 60/111-3 (1087/PK) (Repl. CAV 296) | 60/240-65 (SLT.4419/260) Ht.: 211mm Filet / Thread 1" (85 Export) |
| | 60/161-112 (TM.254) (Conique, vis centrale Conical type, central nut) (1/83 ↔) | 60/162-112 (TM.255) | | | 60/240-66 (SLT.4419/280) Ht.: 232mm Filet / Thread M40x2 (85 Special) |
| Minitauro C | | | 60/97-2 (599AR/F) | 60/111-3 (1087/PK) (Repl. CAV 296) | |
| Minitauro 55, Leone 70, Leone 75 | 60/161-54 (2127) (Sans ailettes Less fins) | | 60/96-3 (102T) (Cartouche Cartridge) ou / or 60/97-2 (599AR/F) (A visser / Spin on) | 60/111-64 (F.1007) + 60/111-32 (1007) ou / or 60/111-3 (1087/PK) (Repl. CAV 296) | |
| Minitauro 60, Minitauro 60 Frutteto | 60/161-62 (2498) | 60/162-62 (2499) | 60/97-2 (599AR/F) | | |
| Minitauro 60 Syncro | | | | | 60/240-64 (SLT.4419/250) Ht.: 143mm Filet / Thread 1" |
| Minitauro 60, 60 Syncro, Minitauro C | | | 60/97-36 (294/F) | 60/111-3 (1087/PK) (Repl. CAV 296) | |
| Minitauro, Frutteto | 60/161-112 (TM.254) | 60/162-112 (TM.255) | | | |

Les références des pièces sont indicatives.
Nos pièces ne sont pas d'origine.

Part numbers are quoted for reference purposes only.
Our parts and accessories are not original.



"THE RELIABLE SERVICE"



| Tracteurs Tractors | 1 | | 2 | 3 | 4 |
|------------------------|---|----------------------------|-----------------------------|---|--|
| | Air | | Huile Oil | Combustible Fuel | Hydraulique Hydraulic |
| | Ext. / Out. | Int. / Inn. | | | |
| Panther 88 | 60/161-59 (2449) | 60/162-59 (2464) | 60/97-38 (309/F) | 60/111-3 (1087/PK) (Repl. CAV 296) | |
| Panther 90 | 60/161-59 (2449) Couvercle / Cap Ø 133mm (↔ Série / Serie 5000) | 60/162-59 (2464) | | | |
| | 60/161-60 (2465) Couvercle / Cap Ø 155mm (Série / Serie 5001 ↔) | 60/162-25 (2466) | | 60/111-4 (1193/F) (Repl. CAV 796) | |
| | ou / or 60/161-104 (TFA.581) Couvercle / Cap Ø 214mm | 60/162-25 (2466) | | | |
| Panther 95 | 60/161-60 (2465) Couvercle / Cap Ø 155mm (↔ Série / Serie 2606) | 60/162-25 (2466) | | | 60/240-65 (SLT.4419/260) Ht.: 211mm Filet / Thread 1" |
| | 60/161-104 (TFA.581) Couvercle / Cap Ø 214mm (Série / Serie 2607 ↔) | 60/162-25 (2466) | | | |
| Ranger 45, 45 Frutteto | 60/161-63 (2500) | 60/162-1 (568) | 60/97-2 (599AR/F) | 60/111-3 (1087/PK) (Repl. CAV 296) | |
| Row Crop 80 | 60/161-62 (2498) | | 60/97-36 (294/F) | | |
| | | | | | 60/240-64 (SLT.4419/250) Ht.: 143mm Filet / Thread 1" ou / or 60/240-69 (SLT.4419/350) Ht.: 180mm Filet / Thread M40x2 |

Les références des pièces sont indicatives.
Nos pièces ne sont pas d'origine.

Part numbers are quoted for reference purposes only.
Our parts and accessories are not original.



"THE RELIABLE SERVICE"



| Tracteurs Tractors | 1 | | 2 | 3 | 4 |
|---|---|---|----------------------------|---|--|
| | Air | | Huile Oil | Combustible Fuel | Hydraulique Hydraulic |
| | Ext. / Out. | Int. / Inn. | | | |
| Row Crop 85 | 60/161-62 (2498) ou / or 60/161-66 (7293) (Conique 2 pattes Conical type 2 fixings holes) (⇨ 12/82) 60/161-112 (TM.254) (Conique, vis centrale Conical type, central nut) (1/83 ⇨) | 60/162-66 (7285) 60/162-112 (TM.255) | 60/97-36 (294/F) | 60/111-3 (1087/PK) (Repl. CAV 296) | 60/240-69 (SLT.4419/350) Ht.: 180mm Filet / Thread M40x2 |
| Sametto, Sametto 120 | | | | 60/111-28 (1009) | |
| Sametto V, VDT | | | 60/96-24 (101/F) | | |
| Saturno 80 (2RM / WD), Saturno 80 (4RM / WD) | 60/161-63 (2500) Ht.: 235mm (⇨ Série / Serie 9356) 60/161-62 (2498) Ht.: 265mm (Série / Serie 9357 ⇨) | 60/162-62 (2499) | 60/97-36 (294/F) | 60/111-3 (1087/PK) (Repl. CAV 296) | |
| Saturno 80 Syncro | 60/161-62 (2498) | 60/162-62 (2499) | | | |
| Silver 80.DT (2RM / WD) Moteur 1000.4-A4 80HP Engine | | | | | 60/240-66 (SLT.4419/280) Ht.: 232mm Filet / Thread M40x2 |
| Silver 90.DT (2RM / WD) Moteur 1000.4AT2 90HP Engine | | | 60/97-22 (169) | | |
| Silver 100.4 DT Moteur 1000.4AT1 100HP Engine | 60/161-104 (TFA.581) | 60/162-25 (2466) | 60/97-21 (121) | 60/111-4 (1193/F) (Repl. CAV 796) | 60/240-67 (SLT.4419/320) Ht.: 264mm Filet / Thread M40x2 |
| Silver 100.6 Moteur 1000.6A1 100HP Engine | | | | | |
| Sirenetta (2RM / WD), (4RM / WD) | 60/161-87 (2477) Ht.: 185mm ou / or 60/162-63 (2500) Ht.: 235mm | | 60/97-4 (305/F) | 60/111-3 (1087/PK) (Repl. CAV 296) | |

Les références des pièces sont indicatives.
Nos pièces ne sont pas d'origine.

Part numbers are quoted for reference purposes only.
Our parts and accessories are not original.



"THE RELIABLE SERVICE"



| Tracteurs Tractors | 1 | | 2 | 3 | 4 |
|---|--|---|------------------------------------|--|--|
| | Air | | Huile Oil | Combustible Fuel | Hydraulique Hydraulic |
| | Ext. / Out. | Int. / Inn. | | | |
| Solar 50 | 60/161-112 (TM.254) | 60/162-112 (TM.255) | 60/97-2 (599AR/F) | 60/111-3 (1087/PK) (Repl. CAV 296) | 60/240-66 (SLT.4419/280) Ht.: 232mm Filet / Thread M40x2 |
| Solar 55, 55C, 55C Compact, 60 | | | 60/97-36 (294/F) | | 60/240-69 (SLT.4419/350) Ht.: 180mm Filet / Thread M40x2 |
| Solar 60C Ergomatic | | | | | |
| Solaris 35 Moteur Mitsubishi K4F-D Engine | 60/161-63 (2500) | 60/162-1 (568) | 60/240-66 (SLT.4419/280) | | |
| Taurus C | | | 60/97-2 (599AR/F) | 60/111-3 (1087/PK) (Repl. CAV 296) | |
| Taurus 60 Export | 60/161-59 (2449) (↔ Série / Serie 2675) | 60/162-59 (2464) | 60/97-36 (294/F) | | 60/240-64 (SLT.4419/250) Ht.: 143mm Filet / Thread 1" |
| | 60/161-66 (7293) (Conique, 2 pattes Conical type 2 fixings holes) (Série / Serie 2676 ↔) ou / or 60/161-112 (TM.254) (Conique, vis centrale Conical type, central nut) | 60/162-66 (7285) 60/162-112 (TM.255) | | | |
| Tiger 100 (2RM / WD), Tiger 100 (4RM / WD) | 60/161-60 (2465) Couvercle / Cap Ø 155mm (↔ 8/81) | 60/162-25 (2466) | 60/97-38 (309/F) | 60/111-3 (1087/PK) (Repl. CAV 296) ou / or 60/111-4 (1193/F) (Repl. CAV 796) | |
| Tiger Six 105 | 60/161-104 (TFA.581) Couvercle / Cap Ø 214mm (9/81 ↔) | 60/162-25 (2466) | | | 60/111-4 (1193/F) (Repl. CAV 796) |
| Titan 145 | 60/161-64 (2553) | 60/162-64 (TFA.734) | 60/97-21 (121) | 60/111-4 (1193/F) (Repl. CAV 796) | 60/240-67 (SLT.4419/320) Ht.: 264mm Filet / Thread M40x2 |
| Titan 160 Turbo Moteur 1000.6AT1 159HP Engine | | | | | |
| Titan 190 Turbo Moteur 1000.6WTIR 189HP Engine | | | | | |

Les références des pièces sont indicatives.
Nos pièces ne sont pas d'origine.

Part numbers are quoted for reference purposes only.
Our parts and accessories are not original.



"THE RELIABLE SERVICE"



| Tracteurs Tractors | 1 | | 2 | 3 | 4 |
|-----------------------|--|-------------------------------|----------------------------|---|--|
| | Air | | Huile Oil | Combustible Fuel | Hydraulique Hydraulic |
| | Ext. / Out. | Int. / Inn. | | | |
| Trident 130 Export | 60/161-60 (2465) Couvercle / Cap Ø 155mm (Φ 8/81) | 60/162-25 (2466) | 60/97-38 (309/F) | 60/111-4 (1193/F) (Repl. CAV 796) | 60/240-67 (SLT.4419/320) Ht.: 264mm Filet / Thread M40x2 |
| | 60/161-104 (TFA.581) Couvercle / Cap Ø 214mm (9/81 Φ) | 60/162-25 (2466) | | | |
| Toro, Toro V, AT, TS | | | 60/96-3 (102T) | 60/111-64 (F.1007) + 60/111-32 (1007) | |
| Vigneron 35, 45, 50 | 60/161-63 (2500) Ht.: 235mm | | 60/97-4 (305/F) | 60/111-3 (1087/PK) (Repl. CAV 296) | |
| Vigneron 60, 62, 70 | 60/161-112 (TM.254) | 60/162-112 (TM.255) | 60/97-36 (294/F) | | |

Filtre de direction assistée
Power steering filter
60/574-15
 (S.136/6376)

 Ø 86mm
 Ht.: 38mm

Leopard, Centurion, ...

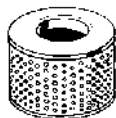
 Les références des pièces sont indicatives.
 Nos pièces ne sont pas d'origine.

 Part numbers are quoted for reference purposes only.
 Our parts and accessories are not original.

FILTRATION - LAMBORGHINI
FILTERS - LAMBORGHINI

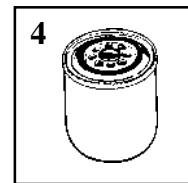
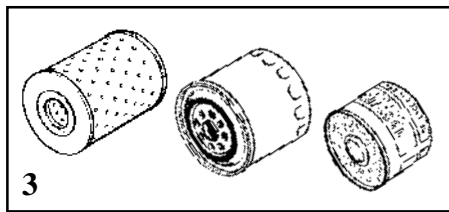
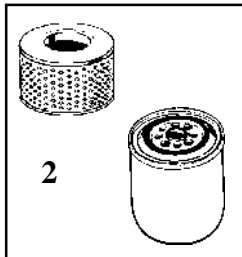
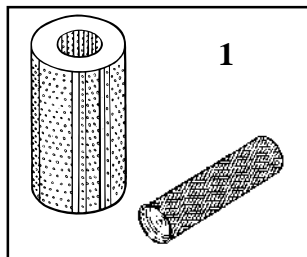

| Tracteurs Tractors | 1 | | 2 | 3 | 4 |
|--|---|--------------------------------|----------------------------|---|--|
| | Air | | Huile Oil | Combustible Fuel | Hydraulique Hydraulic |
| | Ext. / Out. | Int. / Inn. | | | |
| 1R, 1C | | | | 60/111-32 (1007) | |
| 2R, 4R, 5C, 4C | | | | 60/111-64 (F.1007) | |
| 7R, 7RDT, R 355 | | | | + | 60/96-3 (102T) |
| 105 Formula Power Speed | | | | 60/111-3 (1087/PK) (Repl. CAV 296) | |
| 115, 135 Formula Moteur 100.WT6 Engine | 60/161-104 (TFA.581) | 60/162-25 (2466) | 60/97-38 (309/F) | 60/111-16 (1194/F) | 60/240-69 (SLT.4419/350) Ht.: 180mm Filet / Thread M40x2 |
| 165, 190 Racing Moteur 100.WT6 Turbo Engine | | | | + | |
| 165 Racing | | | 60/97-22 (169) | 60/111-4 (1193/F) (Repl. CAV 796) | |
| R 226, C 226 | | | | 60/111-32 (1007) | 60/96-2 (103) |
| R 230, C 230, C 230S | | | | | |
| R 235, R 235DT | 60/161-63 (2500) | 60/162-1 (568) | 60/97-4 (305/F) | 60/111-3 (1087/PK) (Repl. CAV 296) | |
| R 240 | | | 60/97-36 (294/F) | 60/111-39 (1158) | |
| R 340, C 340, C 350 | | | | 60/111-64 (F.1007) | |
| | | | | + | 60/111-32 (1007) |
| R 345 | 60/161-112 (TM.254) (Conique, vis centrale Conical type, central nut) | 60/162- 112 (TM.255) | 60/97-36 (294/F) | 60/111-3 (1087/PK) (Repl. CAV 296) | |

Les références des pièces sont indicatives.
Nos pièces ne sont pas d'origine.

Part numbers are quoted for reference purposes only.
Our parts and accessories are not original.



| Tracteurs Tractors | 1 | | 2 | 3 | 4 |
|--|---|-------------------------------|-----------------------------|---|---|
| | Air | | Huile Oil | Combustible Fuel | Hydraulique Hydraulic |
| | Ext. / Out. | Int. / Inn. | | | |
| R 350 | | | 60/97-38 (309/F) | 60/111-39 (1158) | |
| C 352, C 352L, C 352S, C 352SL | 60/161-8 (2543) | 60/162-8 (2544) | 60/97-4 (305/F) | 60/111-3 (1087/PK) (Repl. CAV 296) | |
| C 353L, C 353LL, CL 653, C 653L | | | 60/97-2 (599AR/F) | | |
| R 360, R 365, 452, R 470, R 475, 480, 485 | | | | 60/111-64 (F.1007) + 60/111-32 (1007) | |
| C 483 | | | 60/97-4 (305/F) | 60/111-3 (1087/PK) (Repl. CAV 296) | 60/240-68 (SLT.4419/270) Ht.: 186mm Filet / Thread 1 1/8" |
| R 500, R 550DT | 60/161-112 (TM.254) (Conique, vis centrale Conical type, central nut) | 60/162-112 (TM.255) | 60/97-2 (599AR/F) | | |
| C 503, C 603 Moteur Same 983P Engine | 60/161-8 (2543) | 60/162-8 (2544) | | | |
| C 503S, C 553S | | | 60/240-46 (652) | | |
| R 503S, R 503DTS, R 603, R 603DT | | | 60/97-38 (309/F) | 60/111-39 (1158) | 60/240-11 (529) (Cartouche Cartridge) |
| C 553P, C 653P Moteur Same 1053P Engine | | | 60/97-4 (305/F) | 60/111-3 (1087/PK) (Repl. CAV 296) | |
| C 554, C 554 Compact Ergomatic 554-50, 564-60 Moteur 1003.3A Engine | 60/161-112 (TM.254) (Conique, vis centrale Conical type, central nut) | 60/162-112 (TM.255) | 60/97-36 (294/F) | | |
| 574-74 Moteur 1003.3A Engine, R 574-60N, R 674-70, R 674-70N, C 674-70 Ergomatic, R 674-70 Grand Prix | | | | | 60/240-69 (SLT.4419/350) Ht.: 180mm Filet / Thread M40x2 |
| C 583 | | | 60/97-4 (305/F) | | 60/240-68 (SLT.4419/270) Ht.: 186mm Filet / Thread 1 1/8" |
| R 583 | | | 60/97-38 (309/F) | | |
| R 600, R 600DT | 60/161-112 (TM.254) (Conique, vis centrale Conical type, central nut) | 60/162-112 (TM.255) | 60/97-36 (294/F) | | 60/240-66 (SLT.4419/280) Ht.: 232mm Filet / Thread M40x2 |
| C 653 | | | 60/97-4 (305/F) | | |

Les références des pièces sont indicatives.
Nos pièces ne sont pas d'origine.

Part numbers are quoted for reference purposes only.
Our parts and accessories are not original.



"THE RELIABLE SERVICE"



| Tracteurs Tractors | 1 | | 2 | 3 | 4 |
|---|---|--------------------------------|----------------------------|---|--|
| | Air | | Huile Oil | Combustible Fuel | Hydraulique Hydraulic |
| | Ext. / Out. | Int. / Inn. | | | |
| R 653, R654, R654DT | | | | | 60/240-11 (529) (Cartouche Cartridge) |
| R 660, R 660DT, C664 Ergomatic | 60/161-112 (TM.254) (Conique, vis centrale Conical type, central nut) | 60/162- 112 (TM.255) | 60/97-36 (294/F) | 60/111-3 (1087/PK) (Repl. CAV 296) | |
| R 660 Frutteto, R 660 Vigneto, R 775 Frutteto | | | | | |
| C 683 | | | 60/97-4 (305/F) | | 60/240-68 (SLT.4419/270) Ht.: 186mm Filet / Thread 1 1/8" |
| R 683 | | | 60/97-36 (294/F) | | 60/240-66 (SLT.4419/280) Ht.: 232mm Filet / Thread M40x2 |
| C 684, R 684 | | | | | |
| R 700, R 700DT | 60/161-104 (TFA.581) | 60/162-25 (2466) | | | |
| R 704, R 704DT, R 804, R 804DT Export | | | | 60/111-56 (1157/F) | |
| R 754, R 754DT | | | 60/97-36 (294/F) | 60/111-3 (1087/PK) (Repl. CAV 296) | 60/96-28 (394) (Cartouche Cartridge) |
| R 754 Ergomatic | | | | | 60/240-66 (SLT.4419/280) Ht.: 232mm Filet / Thread M40x2 |
| C 774-80 Ergomatic, R 774-80, R 774-80 Grand Prix | 60/161- 104 (TFA.581) | 60/162-25 (2466) | | | 60/240-68 (SLT.4419/270) Ht.: 186mm Filet / Thread 1 1/8" |
| R 775 Frutteto, R 775 Vigneto, 775F Plus Moteur 1003.3A Engine | | | | | 60/240-69 (SLT.4419/350) Ht.: 180mm Filet / Thread M40x2 |
| R 784, C 784 | | | | | |
| R 854, R 854DT | | | | | 60/96-28 (394) (Cartouche Cartridge) Ht.: 209mm ou / or 60/240-11 (529) (Cartouche Cartridge) Ht.: 177mm |

Les références des pièces sont indicatives.
Nos pièces ne sont pas d'origine.

Part numbers are quoted for reference purposes only.
Our parts and accessories are not original.



"THE RELIABLE SERVICE"



| Tracteurs Tractors | 1 | | 2 | 3 | 4 |
|--|---------------------------------|----------------------------|----------------------------|---|---|
| | Air | | Huile Oil | Combustible Fuel | Hydraulique Hydraulic |
| | Ext. / Out. | Int. / Inn. | | | |
| R 874-90 Turbo, R 874-90 Turbo Grand Prix | 60/161- 104 (TFA.581) | 60/162-25 (2466) | 60/97-22 (169) | 60/111-3 (1087/PK) (Repl. CAV 296) | 60/240-69 (SLT.4419/350) Ht.: 180mm Filet / Thread M40x2 (↻ 3/87) 60/240-68 (SLT.4419/270) Ht.: 186mm Filet / Thread 1 1/8" (4/87 ↻) |
| R 904, R 904DT Export | 60/161-59 (2449) | 60/162-59 (2464) | | 60/111-56 (1157/F) | |
| R 955 | | | 60/97-38 (309/F) | 60/111-4 (1193/F) (Repl. CAV 796) | 60/96-28 (394) (Cartouche Cartridge) (↻ 82) 60/240-68 (SLT.4419/270) Ht.: 186mm Filet / Thread 1 1/8" (83 ↻) |
| R 956, R 956DT, R956-100 | 60/161- 104 (TFA.581) | 60/162-25 (2466) | 60/97-36 (294/F) | | 60/240-66 (SLT.4419/280) Ht.: 232mm Filet / Thread M40x2 |
| 990F Plus Moteur 1000.4WT Engine | | | | | 60/111-3 (1087/PK) (Repl. CAV 296) |
| R 1056, R 1056DT, R 1256 | | | 60/97-38 (309/F) | 60/111-4 (1193/F) (Repl. CAV 796) | 60/96-28 (394) (Cartouche Cartridge) ou / or 60/240-68 (SLT.4419/270) Ht.: 186mm Filet / Thread 1 1/8" |
| R 1106, R 1106DT | 60/161- 104 (TFA.581) | 60/162-25 (2466) | 60/97-36 (294/F) | | 60/240-66 (SLT.4419/280) Ht.: 232mm Filet / Thread M40x2 |
| R 1156, R 1156DT | | | 60/97-38 (309/F) | 60/111-3 (1087/PK) (Repl. CAV 296) | 60/240-68 (SLT.4419/270) Ht.: 186mm Filet / Thread 1 1/8" |
| R 1306DT Turbo | 60/161- 104 (TFA.581) | 60/162-25 (2466) | 60/97-22 (169) | 60/111-4 (1193/F) (Repl. CAV 796) | 60/240-66 (SLT.4419/280) Ht.: 232mm Filet / Thread M40x2 |

Les références des pièces sont indicatives.
Nos pièces ne sont pas d'origine.

Part numbers are quoted for reference purposes only.
Our parts and accessories are not original.



"THE RELIABLE SERVICE"



| Tracteurs Tractors | 1 | | 2 | 3 | 4 | |
|-----------------------|----------------------------|-------------------------------|----------------------------|--|--|---|
| | Air | | Huile Oil | Combustible Fuel | Hydraulique Hydraulic | |
| | Ext. / Out. | Int. / Inn. | | | | |
| R 1356, R 1356DT | 60/161-64 (2553) | 60/162-64 (TFA.734) | 60/97-38 (309/F) | 60/111-4 (1193/F) (Repl. CAV 796) | 60/240-68 (SLT.4419/270) Ht.: 186mm Filet / Thread 1 1/8" (⇄ 12/81) | |
| R 1506DT Turbo | | | | | 60/240-67 (SLT.4419/320) Ht.: 264mm Filet / Thread M40x2 (01/82 ⇄) | |
| R 1556DT | | | | 60/97-21 (121) | 60/111-57 (1167/F) (⇄ 9/81) | 60/240-68 (SLT.4419/270) Ht.: 186mm Filet / Thread 1 1/8" (⇄ 9/81) |
| R 1706DT Turbo | | | | | 60/111-3 (1087/PK) (Repl. CAV 296) (10/81 ⇄) | 60/240-67 (SLT.4419/320) Ht.: 264mm Filet / Thread M40x2 (10/81 ⇄) |
| | | | | 60/111-4 (1193/F) (Repl. CAV 796) | 60/240-68 (SLT.4419/270) Ht.: 186mm Filet / Thread 1 1/8" | |

Les références des pièces sont indicatives.
Nos pièces ne sont pas d'origine.

Part numbers are quoted for reference purposes only.
Our parts and accessories are not original.



"THE RELIABLE SERVICE"



FILTRATION - HÜRLIMANN
FILTERS - HÜRLIMANN

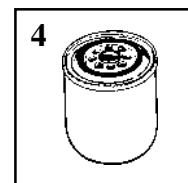
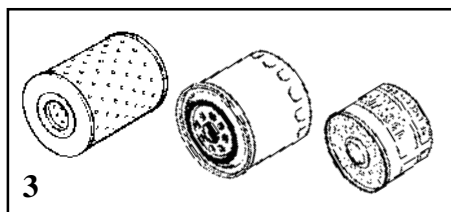
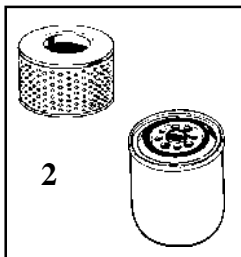
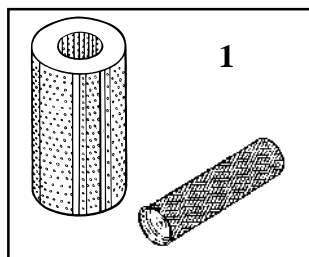

| Tracteurs Tractors | 1 | | 2 | 3 | 4 | | |
|---|---|-------------------------------|-----------------------------|---|--|--|---|
| | Air | | Huile Oil | Combustible Fuel | Hydraulique Hydraulic | | |
| | Ext. / Out. | Int. / Inn. | | | | | |
| D 60, D 70, D 80, D 100 | | | | 60/111-33 (1008) | | | |
| D 95, D 100, D 110, D 115, D 115T, D 150, D 310T | | | 60/97-27 (439) | 60/111-56 (1157/F) | | | |
| D 120 | | | | 60/111-33 (1008) | | | |
| D 180, D 210, D 310, D 500 | | | | 60/111-56 (1157/F) | | | |
| H 35FDT | | | 60/97-36 (294/F) | 60/111-3 (1087/PK) (Repl. CAV 296) | 60/240-69 (SLT.4419/350) Ht.: 180mm Filet / Thread M40x2 | | |
| H 345 | | | 60/97-2 (599AR/F) | | | | |
| H 351 | 60/161-112 (TM.254) | 60/162-112 (TM.255) | 60/97-36 (294/F) | | | | |
| H 355, H 360, H 460, H 465, H 470, H 480, H 485 | 60/161-66 (7293) (Conique, fixation 2 pattes Conical, Installed with 2 screws) | 60/162-66 (7285) | | | | | |
| H 356, H 466, H 466-4 | 60/161-112 (TM.254) | 60/162-112 (TM.255) | | | | | |
| H 358-4, H 358 Prestige | | | | | | | |
| H 360 | 60/161-66 (7293) (Conique, fixation 2 pattes Conical, Installed with 2 screws) | 60/162-66 (7285) | | | | | |
| H 361, H 361 Frutteto | 60/161-112 (TM.254) | 60/162-112 (TM.255) | | | | | |
| | | | | | | | 60/240-69 (SLT.4419/350) Ht.: 180mm Filet / Thread M40x2 (⇨ 12/87) |
| | | | | | | | 60/240-66 (SLT.4419/280) Ht.: 232mm Filet / Thread M40x2 (1/88 ⇨) |

Les références des pièces sont indicatives.
Nos pièces ne sont pas d'origine.

Part numbers are quoted for reference purposes only.
Our parts and accessories are not original.



| Tracteurs Tractors | 1 | | 2 | 3 | 4 | |
|--|---|-------------------------------|----------------------------|--|--|--|
| | Air | | Huile Oil | Combustible Fuel | Hydraulique Hydraulic | |
| | Ext. / Out. | Int. / Inn. | | | | |
| H 362 | 60/161-112 (TM.254) | 60/162-112 (TM.255) | 60/97-36 (294/F) | 60/111-3 (1087/PK) (Repl. CAV 296) | 60/240-66 (SLT.4419/280) Ht.: 232mm Filet / Thread M40x2 | |
| H 372, H 372DT | 60/161-104 (TFA.581) | 60/162-25 (2466) | | | 60/97-22 (169) | 60/240-69 (SLT.4419/350) Ht.: 180mm Filet / Thread M40x2 |
| H 372 Turbo moteur 1000.3AT engine | | | | | | |
| H 460, H 465 moteur 1000.3A engine | 60/161-66 (7293) (Conique, fixation 2 pattes Conical, Installed with 2 screws) | 60/162-66 (7285) | 60/97-36 (294/F) | | | |
| H 466-4 moteur 1000.3A engine | 60/161-112 (TM.254) | 60/162-112 (TM.255) | | | | |
| H 468, H 468 Club, H 478, H 478-4, H 478 Prestige | 60/161-104 (TFA.581) | 60/162-25 (2466) | 60/97-22 (169) | | 60/240-69 (SLT.4419/350) Ht.: 180mm Filet / Thread M40x2 | |
| H 476, H 476 Frutteto | | | | | | |
| H 488T | | | | | | |
| H 490 | 60/161-102 (9516K) | 60/162-102 (9637) | 60/97-38 (309/F) | | 60/96-28 (394) | |
| H 496T | 60/161-104 (TFA.581) | 60/162-25 (2466) | 60/97-22 (169) | | 60/111-4 (1193/F) (Repl. CAV 796) | |
| H 4105 Elite | | | 60/97-38 (309/F) | 60/240-69 (SLT.4419/350) Ht.: 180mm Filet / Thread M40x2 | | |
| H 5105 | | | | | | |
| H 5110 moteur 5 cyl. engine | 60/161-102 (9516K) Ht.: 342mm (↔ 8/81) | 60/162-102 (9637) | 60/97-21 (121) | 60/111-16 (1194/F) (↔ 8/81) | | |
| | 60/161-104 (TFA.581) Ht.: 395mm (9/81 ↔) | 60/162-25 (2466) | | 60/111-4 (1193/F) (Repl. CAV 796) (9/81 ↔) | | |
| H 5116 TURBO | 60/161-104 (TFA.581) | 60/162-25 (2466) | 60/97-38 (309/F) | 60/111-4 (1193/F) (Repl. CAV 796) | 60/240-66 (SLT.4419/280) Ht.: 232mm Filet / Thread M40x2 | |
| H 6115T | | | 60/97-21 (121) | | | |
| H 6125, H 6155 | 60/161-72 (9631) | | 60/97-38 (309/F) | | | |

Les références des pièces sont indicatives.
Nos pièces ne sont pas d'origine.

Part numbers are quoted for reference purposes only.
Our parts and accessories are not original.



"THE RELIABLE SERVICE"



| Tracteurs Tractors | 1 | | 2 | 3 | 4 |
|--|---|---|-----------------------------|--|--|
| | Air | | Huile Oil | Combustible Fuel | Hydraulique Hydraulic |
| | Ext. / Out. | Int. / Inn. | | | |
| H 6130 | 60/161-102 (9516K) Ht.: 342mm (Avec ailettes With fins) ou / or 60/161-83 (944) Ht.: 345mm (Sans ailettes Less fin) | 60/162-102 (9637) 60/162-83 (9617) | 60/97-38 (309/F) | 60/111-4 (1193/F) (Repl. CAV 796) | |
| H 6135 Elite moteur 1000.6WT Turbo engine | | | 60/97-22 (169) | | |
| H 6136 | 60/161-104 (TFA.581) | 60/162-25 (2466) | 60/97-38 (309/F) | | 60/240-66 (SLT.4419/280) Ht.: 232mm Filet / Thread M40x2 |
| H 6136 Turbo | | | | | |
| H 6160 Turbo | 60/162-83 (944) | 60/162-83 (9617) | 60/97-21 (121) | | |
| H 6170T | 60/161-64 (2553) | 60/162-64 (TFA.734) | | | |
| T 5200, T 6200, T 7700 | | | 60/97-2 (599AR/F) | 60/111-56 (1157/F) | |

Références interchangeables Same - Lamborghini - Hürlimann
Cross reference Same - Lamborghini - Hürlimann

| Réf. OEM OEM Ref. | Réf. Cde Order Nr. | Réf. OEM OEM Ref. | Réf. Cde Order Nr. | Réf. OEM OEM Ref. | Réf. Cde Order Nr. | Réf. OEM OEM Ref. | Réf. Cde Order Nr. |
|----------------------|-----------------------|----------------------|-----------------------|----------------------|-----------------------|----------------------|-----------------------|
| 001.0780.0 | 60/111-65 | 2.4249.050.1 | 60/161-62 | 2.4249.131.0 | 60/161-104 | 2.4419.130.1 | 60/97-2 |
| 001.0780.7 | 60/111-33 | 2.4249.050.4 | 60/162-8 | 2.4249.170.6 | 60/161-8 | 2.4419.140.1 | 60/97-4 |
| 002.7793.0 | 60/96-3 | 2.4249.060.1 | 60/161-59 | 2.4249.190.1 | 60/161-63 | 2.4419.150.1 | 60/97-2 |
| 002.7794.0 | 60/96-24 | 2.4249.060.8 | 60/161-59 | 2.4249.250.1 | 60/161-66 | 2.4419.170.1 | 60/97-40 |
| 003.1407.0 | 60/111-28 | 2.4249.070.2 | 60/162-59 | 2.4249.250.2 | 60/162-66 | 2.4419.190.1 | 60/240-46 |
| 003.1408.0 | 60/111-28 | 2.4249.070.4 | 60/162-59 | 2.4249.280.1 | 60/162-64 | 2.4419.210.1/10 | 60/240-68 |
| 003.1412.0 | 60/111-64 | 2.4249.080.1 | 60/161-8 | 2.4249.280.3 | 60/161-64 | 2.4419.250.2 | 60/240-64 |
| 003.1413.0 | 60/111-32 | 2.4249.080.2 | 60/162-8 | 2.4249.290.1 | 60/161-102 | 2.4419.260.2 | 60/240-65 |
| 041.1553.0 | 60/97-38 | 2.4249.090.1 | 60/161-54 | 2.4249.310.0/10 | 60/161-104 | 2.4419.270.1 | 60/240-68 |
| 041.1556.0 | 60/97-38 | 2.4249.110.1 | 60/161-62 | 2.4249.310.4 | 60/161-104 | 2.4419.280.1 | 60/240-66 |
| 044.1551.0 | 60/97-36 | 2.4249.110.2 | 60/161-62 | 2.4249.340.1 | 60/161-112 | 2.4419.320.0 | 60/240-67 |
| 044.1567.0 | 60/97-36 | 2.4249.120.1 | 60/162-62 | 2.4249.340.2 | 60/162-112 | 2.4419.340.0 | 60/97-22 |
| 052.1565.0 | 60/97-21 | 2.4249.120.5 | 60/162-62 | 2.4319.060.1 | 60/111-3 | 2.4419.350.0 | 60/240-69 |
| 136.6376-2/10 | 60/574-15 | 2.4249.130.0 | 60/161-104 | 2.4319.130.1 | 60/111-4 | 2.4419.410.0 | 60/240-68 |
| 2.4249.010.1 | 60/161-87 | 2.4249.130.1 | 60/161-60 | 2.4319.500.1 | 60/111-56 | 2.4529.030.9 | 60/574-15 |
| 2.4249.010.6 | 60/161-87 | 2.4249.130.2 | 60/162-25 | 2.4319.530.3 | 60/111-64 | 4 004 608 | 60/96-3 |
| 2.4249.020.1 | 60/161-54 | 2.4249.130.7 | 60/162-25 | 2.4319.530.4 | 60/111-32 | 7016.255.0 | 60/240-11 |
| 2.4249.040.2 | 60/162-1 | 2.4249.130.8 | 60/161-60 | 2.4419.041.1 | 60/96-19 | 9032.259.0 | 60/96-28 |
| 2.4249.040.3 | 60/162-1 | 2.4249.130.9 | 60/162-25 | 2.4419.100.2 | 60/97-25 | | |

 Les références des pièces sont indicatives.
 Nos pièces ne sont pas d'origine.

 Part numbers are quoted for reference purposes only.
 Our parts and accessories are not original.

"THE RELIABLE SERVICE"

ECHAPPEMENTS
SILENCERS

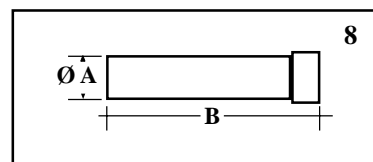
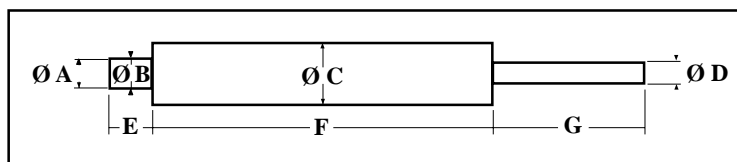
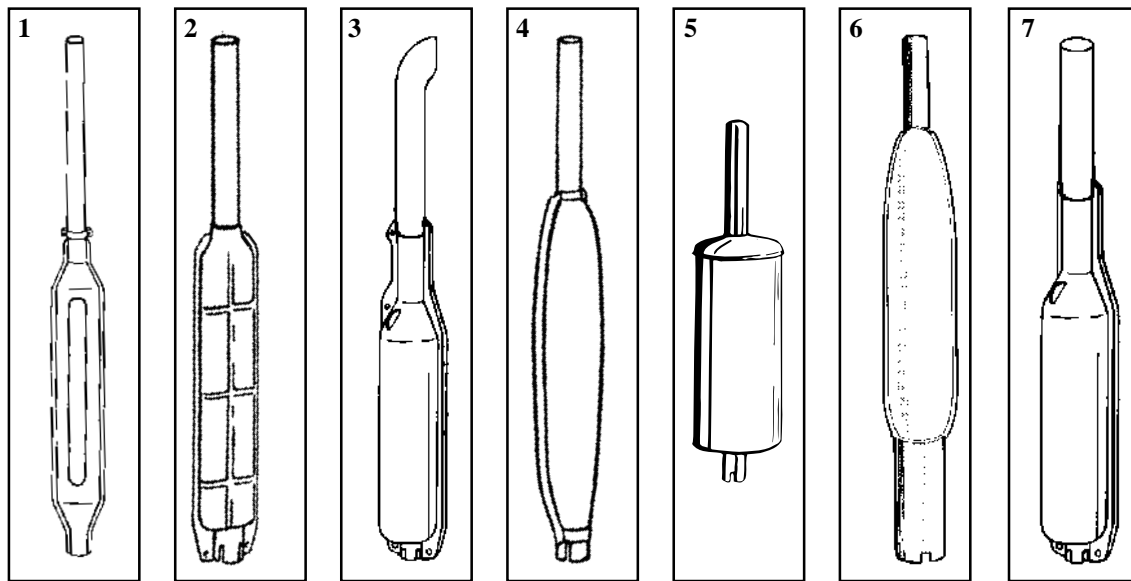



| Tracteurs Tractors | Référence Reference | Fig. Fig. | Forme Shape | Tuyau Pipe | ØA | ØB | Ø C1-C2 | ØD | E | F | G |
|--|------------------------------------|--------------|-----------------|-----------------------------------|----|------|---------|----|-----|-----|-----|
| H.468 Prestige, H.466, H.476, H.478, H.470 Lamb. 674, 774, 874 Aster 60, Explorer 90 Turbo, Explorer 60, 65, 70, 75, 80 | S.255/6303 (25556303/30) | 4 | Rond Round | | 66 | 72 | 120 | 42 | 60 | 700 | 300 |
| Laser 100, 110, 130 Tiger Six 105, Trident 130, Buffalo 130 | S.170/5630 (17056303) | 2 | Rect. Rect. | | 65 | 73 | 178/92 | 48 | 40 | 930 | 280 |
| Delfino 35, Minitauro 60, Corsaro 70 Synchro | S.150/5610 (1505610210) | 3 | Carré Square | | 52 | 60 | 90/100 | | 50 | 600 | 150 |
| Leopard 90 Turbo, Laser 90 | S.250/5630 (25056303) | 7 | Rond Round | | 65 | 70 | 150 | 43 | 65 | 650 | 485 |
| Selon applications Some applications | SLT.5610/65 | 5 | Oval | | 65 | 70 | 90/173 | 61 | 70 | 560 | 440 |
| | SLT.5610/75 | | Oval | | 75 | 78 | 125/210 | 70 | 120 | 720 | 290 |
| | SLT.5610/54 | 1 | Carré Square | | 54 | 58 | 93/96 | 45 | 110 | 620 | 460 |
| | SLT.5610/80 | 6 | Rond | | 80 | 84 | 112 | 50 | 210 | 690 | 435 |
| | SLT.5610/50 | 1 | Rond Round | | 50 | 54 | 98 | 45 | 100 | 660 | 410 |
| Antares 100 Explorer II -60, 70, 80, 90 | | 8 | | 29/166-10 (00839200/20) | 80 | 1115 | | | | | |
| Antares 110, 130 Titan 145, 160, 190 | | | | 29/166-11 (00765140/20) | 60 | 1080 | | | | | |

Les références des pièces sont indicatives.
Nos pièces ne sont pas d'origine.

Part numbers are quoted for reference purposes only.
Our parts and accessories are not original.

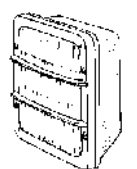
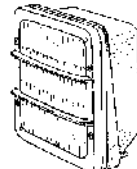
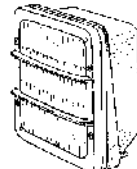
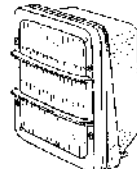

ECLAIRAGE - PHARES AVANTS
LIGHTING - FRONT LIGHT
SAME

| | | | | |
|--------------------|------------------------------------|--|---|---|
| 29/8029-900 | 2.8029.900 2.8029.910.0/10 | Optique de phare <i>Front light lens</i> |  | Explorer série II / <i>Serie</i> Antares 100 |
| 29/7.5269 | 007.5269.0/10 | Optique de phare <i>Front light lens</i> |  | Antares 110, 130 Titan |
| 29/8029-670 | 2.8029.670.0 2.8029.680.0 | Phare avant / <i>Front light</i> Fixation par clips / <i>Fitting with clips</i> Droit, modèle asymétrique / <i>Straight, asymmetrical model</i> |  | Laser, Explorer, Galaxy |
| | | <u>Grille / Grille</u> : S.8029/342 (2.8029.340.2) <u>Glace / Glass</u> : S.8029/341 (2.8029.340.1) <u>Joint / Gasket</u> : S.8029/343 (2.8029.340.3) | | |
| S.8029/170 | 2.8029.170.0/11 2.8029.180.0 | Phare avant / <i>Front light</i> Fixation par clips / <i>Fitting with clips</i> Inclinaison 8° / <i>8° inclination</i> |  | (↔ 1979) |
| | | <u>Grille / Grille</u> : S.8029/10N (2.8029.170.1/10) <u>Glace / Glass</u> : S.8029/93 (2.8029.090.3) <u>Joint / Gasket</u> : S.8029/94 (2.8029.090.4) | | |
| S.8029/160 | 2.8029.150.0/11 2.8029.160.0 | Phare avant / <i>Front light</i> Fixation par clips / <i>Fitting with clips</i> Inclinaison 9° / <i>9° inclination</i> |  | Tous modèles <i>All models</i> 1973-1983 |
| | | <u>Grille / Grille</u> : S.8029/10N (2.8029.170.1/10) <u>Glace / Glass</u> : S.8029/93 (2.8029.090.3) <u>Joint / Gasket</u> : S.8029/94 (2.8029.090.4) | | |
| S.8029/340 | 2.8029.390.0/01 2.8029.400.0/01 | Phare avant / <i>Front light</i> Fixation par clips / <i>Fitting with clips</i> Inclinaison 8° / <i>8° inclination</i> Modèle asymétrique / <i>Asymmetrical model</i> |  | Tous modèles <i>All models</i> 1973-1983 |
| | | <u>Grille / Grille</u> : S.8029/342 (2.8029.340.2) <u>Glace / Glass</u> : S.8029/341 (2.8029.340.1) <u>Joint / Gasket</u> : S.8029/343 (2.8029.340.3) | | |





Les références des pièces sont indicatives.
Nos pièces ne sont pas d'origine.

Part numbers are quoted for reference purposes only.
Our parts and accessories are not original.

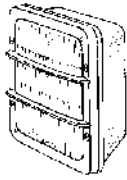
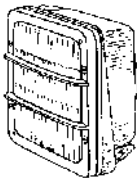
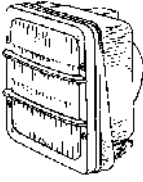

ECLAIRAGE - PHARES AVANTS
LIGHTING - FRONT LIGHT

LAMBORGHINI - HÜRLIMANN

| | | | | |
|---------------------|-----------------|--|---|--|
| 29/8029-900 | 2.8029.900 | Optique de phare <i>Front light lens</i> |  | Séries 674, 774, 874 <i>Series</i> |
| 29/8029-700 | 2.8029.700.0/10 | Optique de phare <i>Front light lens</i> |  | Séries 956, 1256, 1356 <i>Series</i> |
| S.8029/630 | 2.8029.630.0 | Phare avant / <i>Front light</i> Fixation par vis / <i>Screw connection</i> Droit / <i>Straight</i> <u>Grille / Grille</u> : S.8029/10N (2.8029.170.1/10) <u>Glace / Glass</u> : S.8029/93 (2.8029.090.3) <u>Joint / Gasket</u> : S.8029/94 (2.8029.090.4) |  | Suivant applications <i>Some applications</i> |
| SLT.8029/620 | 2.8029.260.0 | Phare avant / <i>Front light</i> Fixation par clips / <i>Fitting with clips</i> Inclinaison 8° / <i>8° inclination</i> <u>Grille / Grille</u> : S.8029/10N (2.8029.170.1/10) <u>Glace / Glass</u> : S.8029/93 (2.8029.090.3) <u>Joint / Gasket</u> : S.8029/94 (2.8029.090.4) |  | Suivant applications <i>Some applications</i> |
| SLT.8029/660 | 2.8029.660.0 | Phare avant / <i>Front light</i> Fixation par clips / <i>Fitting with clips</i> Inclinaison 8° / <i>8° inclination</i> Modèle asymétrique / <i>Asymetrical model</i> <u>Grille / Grille</u> : S.8029/342 (2.8029.340.2) <u>Glace / Glass</u> : S.8029/341 (2.8029.340.1) <u>Joint / Gasket</u> : S.8029/343 (2.8029.340.3) |  | Suivant applications <i>Some applications</i> |
| 27/1700HU | 2.8029.410.0 | Phare complet / <i>Complete front light</i> <u>Glace / Glass</u> : 27/1701HU |  | H.360, H.370 |
| SLT.8029/310 | 2.8029.310.0/10 | Optique de phare Ø 144mm <i>Front light lens Ø 144mm</i> |  | 573, 673, R.654, R.674, R.684 |
| SLT.188/250 | | Cercle de phare <i>Light circle</i> | | |
| SLT.30/3323 | | Coiffe <i>Cowl</i> | | |





Les références des pièces sont indicatives.
Nos pièces ne sont pas d'origine.

Part numbers are quoted for reference purposes only.
Our parts and accessories are not original.



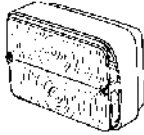

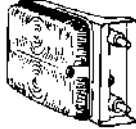
ECLAIRAGE - FEUX DE POSITION & CLIGNOTANTS
LIGHTING - SIDE LIGHTS & INDICATORS

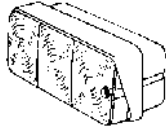
SAME

| | | | | |
|-----------------------------|-----------------------------|---|---|---|
| S.8019/20 | 2.8019.200.0/02 | <u>Cabochon / Glass</u> : S.8019/201 (2.8019.200.1) |  | Suivant applications <i>Some applications</i> |
| S.8019/400 | 2.8019.480.0/02 | <u>Cabochon / Glass</u> : S.8019/481 |  | Taurus, Centurion |
| S.8019/960 (G/LH) | 2.8019.960.0/02 402067AA | <u>Cabochon / Glass</u> : S.8019/201 |  | Laser 110 Titan 145-160-190 Antares 100 Aster 60-70 Explorer II 60-70-80-90 |
| S.8019/970 (D/RH) | 2.8019.970.0/02 | | | |
| S.8019/720 | 2.8019.720.0/10 |  |  | Suivant applications <i>Some applications</i> |

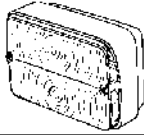
LAMBORGHINI - HÜRLIMANN

| | | | | |
|-----------------------------|-----------------|---|---|--|
| S.8019/20 | 2.8019.200.0/02 | <u>Cabochon / Glass</u> : S.8019/201 (2.8019.200.1) |  | Suivant applications <i>Some applications</i> |
| S.8019/159 (D/RH) | 400481AA | 169 x 62 mm |  | Suivant applications <i>Some applications</i> |
| S.8019/158 (G/LH) | 400480AA | <u>Cabochons / Glass</u> : S.8019/161 (D/RH) (2.8019.460.1) S.8019/160 (G/LH) (2.8019.470.1) | | |



Les références des pièces sont indicatives.
Nos pièces ne sont pas d'origine.

Part numbers are quoted for reference purposes only.
Our parts and accessories are not original.

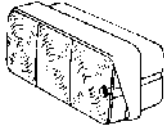

ECLAIRAGE - FEUX ARRIÈRES
LIGHTING - REAR LIGHTS

SAME

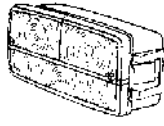
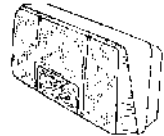
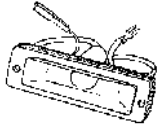
| | | | | |
|-------------------------------|---------------------------------|---|---|--|
| S.8019/19 | | Eclaire-plaque amovible <i>Removable number plate light</i> <u>Cabochon / Glass</u> : S.8019/181 (2.8019.860) |  | Same Delfino, Centaurio, Drago, Minitauro, Tiger |
| S.8019/430 (D/RH) | 2.8019.490.0/02 | Avec éclaire-plaque / <i>With number plate light</i> <u>Cabochons / Glass</u> : S.8019/490 (D/RH) (2.8019.490.1) |  | Centurion 75 |
| S.8019/420 (G/LH) | 2.8019.740.0/02 | S.8019/740 (G/LH) (2.8019.740.1) | | |
| SLT.8059/090 (D/RH) | 2.8059.090.0/02 2.8059.160.0 | 177 x 81 mm <u>Cabochons / Glass</u> : SLT.8059/091 (D/RH) (2.8059.090.1) |  | Explorer |
| SLT.8059/080 (G/LH) | 2.8059.150.0, 2.8059.080.0 | SLT.8059/081 (G/LH) (2.8059.080.1) | | |
| 29/8019-980 (D/RH) | 2.8019.980.0/20 | 280 x 120mm <u>Cabochons / Glass</u> : 29/8019-981 (D/RH) (2.8019.980.1) |  | Laser |
| 29/8019-990 (G/LH) | 2.8019.990.0/20 | 29/8019-991 (G/LH) (2.8019.990.1) | | |
| 29/8059-010 | | Eclaire-plaque / <i>Number plate light</i> |  | Explorer Laser-Galaxy |

LAMBORGHINI - HÜRLIMANN

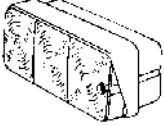
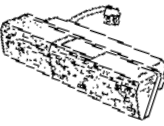
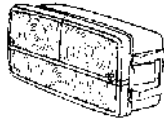
| | | | | |
|-------------------------------|---------------------------------|---|---|--|
| S.8019/19 | | Eclaire-plaque amovible <i>Removable number plate light</i> <u>Cabochon / Glass</u> : S.8019/181 (2.8019.860) |  | Séries 503, 653, 953, 956 Series |
| S.8019/2351 (D/RH) | 2.8019.440.0 400483AA | 300 x 60mm <u>Cabochons / Glass</u> : S.8019/2353 (D/RH) (2.8019.400.1) |  | Suivant applications <i>Some applications</i> |
| S.8019/2350 (G/LH) | 2.8019.450.0 400482AA | S.8019/2352 (G/LH) (2.8019.450.1) | | |
| SLT.8059/090 (D/RH) | 2.8059.090.0/02 2.8059.160.0 | 177 x 81 mm <u>Cabochons / Glass</u> : SLT.8059/091 (D/RH) (2.8059.090.1) |  | H.356, H.466, H.478, H.488, R.674, 774, 874 |
| SLT.8059/080 (G/LH) | 2.8059.150.0, 2.8059.080.0 | SLT.8059/081 (G/LH) (2.8059.080.1) | | |

Les références des pièces sont indicatives.
Nos pièces ne sont pas d'origine.

Part numbers are quoted for reference purposes only.
Our parts and accessories are not original.

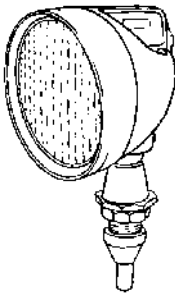

ECLAIRAGE - PHARES DE TRAVAIL
LIGHTING - PLOUGH LAMPS

| | | | |
|---------------------|-----------|--|---|
| S.8029/2T | 280293000 | <p>Ø 105mm - Avec interrupteur Ø 105mm - With switch</p> <p><u>Ampoule / Bulb</u> : 63/1955-96 (Ex. : 10/12247) 12V, 45W</p> <p><u>Glace / Glass</u> : S.8029/590</p> |  |
| 29/8029.460 | 280294600 | <p>Ø 125mm - Avec interrupteur Ø 125mm - With switch</p> <p><u>Ampoule / Bulb</u> : 63/1955-96 (Ex. : 10/12247) 12V, 45W</p> <p><u>Glace / Glass</u> : 29/8029/461</p> | |
| SLT.8029/450 | 280294400 | <p>Ø 130mm - Avec interrupteur Ø 130mm - With switch</p> <p><u>Ampoule / Bulb</u> : 63/1955-453 (Ex. : 10/12336) H3, 12V, 55W</p> <p><u>Optique / Front light lens</u> : 29/8029/440</p> | |

63/1931-3
(ET.5171)

TWIN-POWER

Réflecteur à surface complexe
Boîtier plastique anti-choc
Très large amplitude
Halogène H3 - Sans poignée

*Work lamp with free-form reflector
Extremely wide-angled illumination
Halogen H3 - Less handle*

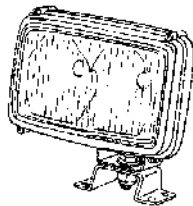

Ampoules / Bulbs : **63/1955-453** (12V./55W)(2x)
(Ex : 10/12336)

63/1931-5
(10/W.394)

Phare orientable 360°
Halogène H3 - 112 x 126mm
(Glace : 82 x 82mm)

*Adjustable lamp 360°
Halogen H3 - 112 x 126mm
(Glass : 82 x 82mm)*

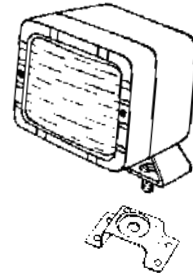

Ampoule / Bulb : **63/1955-453** (12V./55W)
(Ex : 10/12336)

63/1934-5 (ET.131) Support de 1931-5 / Bracket for 1931-5

63/1931-4
(ET.1253/F)

Halogène H3
Avec interrupteur

*Halogen H3
With switch*

Ampoule / Bulb : **63/1955-453** (12V./55W)
(Ex : 10/12336)

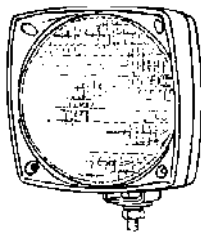

63/1931-6
(ET.1251/H)

182 x 100mm
Halogène H3
Halogen H3

Ampoule / Bulb : **63/1955-453** (12V./55W)
(Ex : 10/12336)

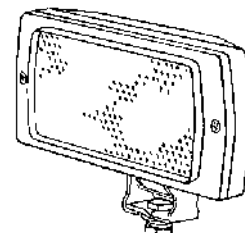

Les références des pièces sont indicatives.
Nos pièces ne sont pas d'origine.

Part numbers are quoted for reference purposes only.
Our parts and accessories are not original.



BOUTONS POUSSOIRS
BUTTONS

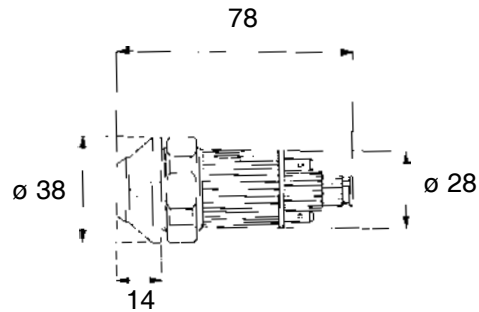

| | Réf. Ref. | OEM | Description Description |
|--|--------------|---------------------------|---|
| | 63/1884-4 | S.L.H. 008.1277.0 | Automatique Bouton poussoir "Push push" avec éclairage 12V <i>Automatic Push push switches with 12 V bulb</i> |
| | 63/1884-5 | S.L.H. 2.7659.111.0 | Feu de travail arrière Bouton poussoir "Push push" avec éclairage 12V <i>Back side lights Push push switches with 12 V bulb</i> |
| | 63/1884-6 | S.L.H. 2.7659.109.0 | Feu de travail avant Bouton poussoir "Push push" avec éclairage 12V <i>Front side light Push push switches with 12 V bulb</i> |
| | 63/1884-7 | S.L.H. 27659.118.0 | Gyrophare Bouton poussoir "Push push" avec éclairage 12V <i>Rotating light Push push switches with 12 V bulb</i> |
| | 63/1884-8 | S.L.H. 008.1335.0 | Blocage du différentiel Bouton poussoir "Push push" avec éclairage 12V <i>Differential lock Push push switches with 12 V bulb</i> |
| | 63/1884-9 | S.L.H. 007.5944.0/20 | Blocage du différentiel Bouton poussoir "Push push" avec éclairage 12V <i>Differential lock Push push switches with 12 V bulb</i> |
| | 63/1884-10 | S.L.H. 007.5945.0/20 | Enclenchement du pont avant Bouton poussoir "Push push" avec éclairage 12V <i>4 wheel drive Push push switches with 12 V bulb</i> |
| | 63/1884-11 | S.L.H. 2.7659.110.0 | Feu de détresse Bouton poussoir "Push push" avec éclairage 12V <i>Hazard Push push switches with 12 V bulb</i> |
| | 63/1884-12 | S.L.H. 2.7659.113.0 | Arrêt moteur Bouton poussoir "Push push" avec éclairage 12V <i>Engine stop Push push switches with 12 V bulb</i> |
| | 63/1884-14 | S.L.H. 2.7659.108.0/10 | Commande de prise de force Bouton poussoir "Push push" avec éclairage 12V <i>P.T.O. command Push push switches with 12 V bulb</i> |
| | 63/1884-20 | S.L.H. 008.80490 | Monter/descendre Bouton poussoir "Push" avec éclairage 12V <i>Lift & lower Push switches with 12 V bulb</i> |

Les références des pièces sont indicatives.
Nos pièces ne sont pas d'origine.

Part numbers are quoted for reference purposes only.
Our parts and accessories are not original.



INSTRUMENTS DE BORD
INSTRUMENTS (MISCELLANEOUS)

COMPTE-HEURES
TACHOMETER

S.7049/610 Saturno, Corsaro, Mercury,
(270494300) Centurion, Centauro,
Taurus, Trident,
Tiger, Leopard, Jaguar

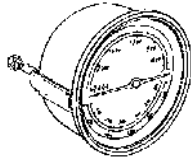

S.7049/270 Drago, Buffalo,
(270493200) Saturno, Corsaro

S.7049/660 Explorer 65, 70, 75, 80, 90
(27049660) Lamborghini : 674, 774, 874

RENOVI
GEAR DRIVE

S.7049/670 Explorer 65, 70, 75, 80, 90
Lamborghini :
674, 774, 874

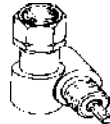

CABLES D'ARRET
STOP CABLE

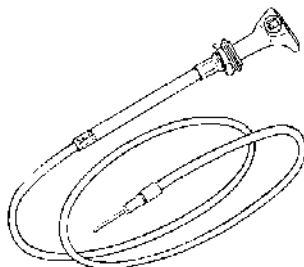

S.169/6730 Tiger Lg. : 795mm

29/169-6730 Buffalo, Tiger

TRANSMISSIONS FLEXIBLES
DRIVE CABLES



S.154/7464 Drago, Buffalo

S.158/7450 Corsaro, Saturno

S.167/7451 Same :
Buffalo, Leopard, Centurion, Hercule,
Taurus, Tiger, Jaguar
Lamborghini : 754
Hürlimann : 490

S.179/7435 Minitauro, Corsaro

29/235.7435 Explorer 55, 65, 70
Trident

29/255.7435 Explorer 75, 80,85, 90 (≠1 Série/Serie)
Lamborghini : 674, 774, 874

26/290.7435 Explorer 75, 80,85, 90 (≠2 Série/Serie)

29/264.7435 Laser 90, 100, 110, 130, 150
Galaxy

S.150/7462 Same :
Delfino 32
Lg. : 1150mm

SLT.150/7450 Lamborghini :
R854, 855, 1056, 1156
Lg. : 1000mm

CONNECTEUR
PLUG SOCKET

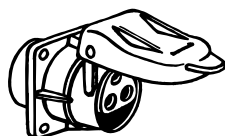

10/250110
Prise 2 pôles
2 point socket poles



10/250331
Prise 2 pôles
2 point socket poles

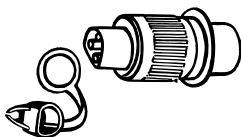

10/250112
Fiche 2 pôles
2 point socket

Les références des pièces sont indicatives.
Nos pièces ne sont pas d'origine.

Part numbers are quoted for reference purposes only.
Our parts and accessories are not original.



INSTRUMENTS DE BORD
INSTRUMENTS (MISCELLANEOUS)

INTERRUPTEURS RECTANGULAIRES
RECTANGULAR SWITCHES

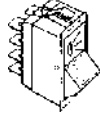

- S.7659/23** Eclairage 3 positions - 7 plots
Lighting 3 positions - 7 plugs
- S.7659/30** Polyvalent - 2 plots
Polyvalent - 2 plugs
- S.7659/64** Phare de travail avant - 5 plots
Front plough lamps - 5 plugs
- 29/7659.065** Phare de travail arrière - 5 plots
Rear plough lamps - 5 plugs
- S.8819/090** Phare de travail 36x18,5
Plough lamps 36x18,5
- S.8819/110** Ventilation
Ventilation
- S.7659/070** Essuie & lave-glaces
Wiper
(2.7659.070.0)
Antares 100, Aster 60, 70
Explorer II 60, 70, 80, 90

INTERRUPTEURS CLIGNOTANTS
INDICATORS SWITCHES

S.7649/4

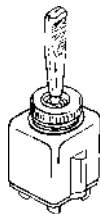

Same
Lamborghini

INTERRUPTEURS FEUX "STOP" & "PTO"
LIGHTS "STOP" & "PTO" SWITCH

S.7649/5
(276490500/10)

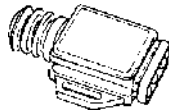

INTERRUPTEURS-SELECTEUR "PTO"
"PTO" SWITCH

- 29/7649-100** Sélecteur 540/1000T
Switch 540/1000T
Same
Antares, Titan
Lamborghini
Selon équipement
According fitment
Hürlimann

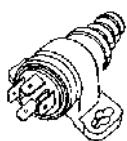

POUSSOIR AVERTISSEUR
HORN SWITCH

S.7409/17
(2.8819.010.0)



BOITE CLIGNOTANTE
FLASHING UNIT

29/8639-003 6 broches/6 pins
2+1+1(8)x21W

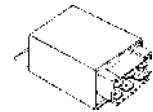

BOITE A FUSIBLES
FUSE HOLDERS

S.7719/002 6 fusibles/6 fuses
S.7719/004 8 fusibles/8 fuses
29/7719-12 12 fusibles/12 fuses

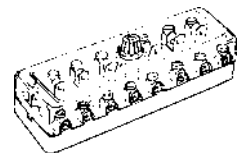

INDICATEURS LUMINEUX
ROCKERS INDICATORS SWITCHES

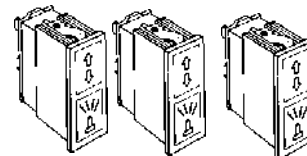

- S.8339/028** Rouge, préchauffage
Red, Starter switch
Vert, indicateur direction
Green, gauge steering
- S.8339/031** Rouge, PTO
Red, PTO
Vert, indicateur direction
Green, gauge steering
- S.8339/020** Vert/vert, remorques
Green/green, Trailers
- S.8339/600** Rouge/rouge, sans sigles
Red/red, less acronym.
- S.8339/019** Rouge, alternateur
Red, alternator
Rouge, pression d'huile
Red, Oil pressure switch
- S.8339/018** Bleu, feux avant
Blue, front lights
Rouge, niveau carburant
Red, Fuel gauge

Les références des pièces sont indicatives.
Nos pièces ne sont pas d'origine.

Part numbers are quoted for reference purposes only.
Our parts and accessories are not original.



INSTRUMENTS DIVERS
INSTRUMENTS (MISCELLANEOUS)

RELAIS
RELAYS

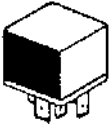
| | | |
|------------------------------------|---|-----------------------|
| 29/7659.016 (1.8050.000) | | 4 plots/ <i>plugs</i> |
| 29/7659.017 (1.8049.000) | | 3 plots/ <i>plugs</i> |
| 29/7659.018 (1.8038.000) |  | 4 plots/ <i>plugs</i> |
| 29/7659.019 (1.8098.000) | | 5 plots/ <i>plugs</i> |
| 29/7659.099 (1.8073.000) | | 5 plots/ <i>plugs</i> |
| S.7659/027 (1.8064.000) | | 5 plots/ <i>plugs</i> |
| 29/7659.028 (1.8059.000) | | 5 plots/ <i>plugs</i> |

INTERRUPTEURS COMBINES
STEERING COLUMN SWITCHES

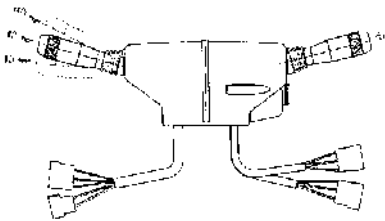

| | |
|------------------------------------|--|
| S.199/8551 | R.653, 1256, 603 |
| 29/254.8450 | R.653, 654, 1256 |
| S.005/1849 | Titan |
| 29/7650.054 (276590540) | Explorer, Laser, Galaxy |
| S.008/1268 (00812684/20) | Same : Antares 110, 130 Titan 145, 160, 190 Lamborghini : Formula 115, 135 Racing 150, 165, 190 Hürlimann : Elite |

CONTACTEURS D'ECLAIRAGE
LICHTING SWITCHES



S.7410/1 0/1/2/3
Plots : 3 simples, 2 doubles
Plugs : 3 singles, 2 doubles



S.7409/3 0/1/2/3 + claxon/*horn*
(2.7409.030.0) Plots : 5 simples
Plugs : 5 singles



S.7409/060 0/1/2/3 + claxon/*horn*
(2.7409.060.0) Plots : 4 simples, 1 double
Plugs : 4 singles, 1 double

REFROIDISSEUR D'HUILE
OIL COOLER

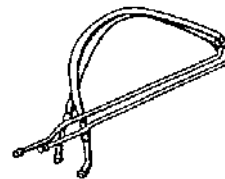

| | |
|--------------------|--|
| S.2115/422K | Centauro, Leone (Paire/ <i>paar</i>) |
| S.37/1542 | Drago Gauche/ <i>LH</i> |
| S.37/1543 | Drago Droit/ <i>RH</i> |

Les références des pièces sont indicatives.
Nos pièces ne sont pas d'origine.

Part numbers are quoted for reference purposes only.
Our parts and accessories are not original.



MECANISMES & DISQUES D'EMBRAYAGE
CLUTCH ASSEMBLIES & PLATES

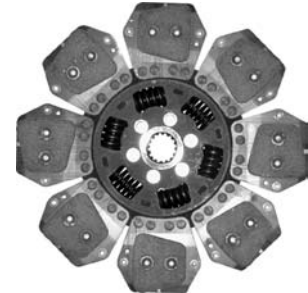

SAME

| Tracteurs Tractors | Embrayage Clutch | | Disque Plate | | Butée de débrayage Release Bearing |
|--|----------------------|---|-----------------|---|---|
| | Ø | N° | Ø | N° | |
| Antares 100 Row Crop 90 (1358 ⇔) Silver 100.6 (⇔ 3222) | 310 DF Valéo | 29/200- 500 Ø Ext. / Out. 368 mm (008.4293.3) (131 0229 30) | 310 | 29/221-501 TC-LT 24Z 36x40 (008.4292.3) (331 0184 30) | 29/231-500 55x91x26 (2.2999.193.0) (500 0076 20) |
| | 310 DF B. & B. | 29/200- 501 Ø Ext. / Out. 365 mm (294.2320.3) (131 0228 50) | 310 | 29/221-502 TF 24Z 36x40 (445.2330.3) (331 0179 36) | |
| | 330 DV Valéo | 29/200-502 (008.4184.3) (133 0220 30) | 330 | 29/221-503 TC-LT 24Z 36,5x41 (009.6533.3) (333 0116 30) 29/221-504 TF 24Z 36,5x41 (008.9937.3) (333 0117 30) | 29/231- 501 MV Lg. 213 mm (2.2999.207.0) (500 0846 30) |
| Antares 100 110 II (⇔ 4243) 127 130 (⇔ 2026) | 330 DV | 29/200-502 (008.4184.3) (133 0220 30) | 330 | 29/221-505 TC-LT 21Z 41x45 (009.9769.3) (333 0115 30) | |
| Antares 130 (2027 ⇔) 130 II 130 V | 350 DV | 29/200-503 (008.5595.3) (135 0241 10) | 348 | 29/221-506 TC-LT 21Z 41x45 (0.008.5596.3) (335 0186 10) | |
| Argon 50 | 250/250 GU6 | 29/200-504 (122.564.4) (225 0055 10) | 250 LG | 29/221-507 UF 20Z 36x40 (122.565.3) (325 0198 10) | 29/231-502 50x82 / 90x22 (2.2999.153.0) (500 0459 00) 29/231-503 65x100x18 (2.2021.017.0) |
| | | | 225 LM | 29/212-501 UF 10Z 22x25 (119.063.3) (323 0556 10) | |

Les références des pièces sont indicatives.
Nos pièces ne sont pas d'origine

Part numbers are quoted for reference purposes only.
Our parts and accessories are not original.



"THE RELIABLE SERVICE"



MECANISMES & DISQUES D'EMBRAYAGE
CLUTCH ASSEMBLIES & PLATES

| Tracteurs Tractors | Embrayage Clutch | | Disque Plate | | Butée de débrayage Release Bearing |
|--|-------------------------|---|--|--|---|
| | Ø | N° | Ø | N° | |
| Argon 60 70 Frutetto 85 II Rock 55, 60, 70 | 280/280 GU6 | 29/200-505 (122.574.4) (228 0133 10) | 280 LG | 29/221-508 UC-LT 20Z 36x40 (122.577.3) (328 0378 12) | 29/231-502 50x82 / 90x22 (2.2999.153.0) (500 0459 00) 29/231-503 65x100x18 (2.2021.017.0) |
| 280 LM | | | 29/212-502 UC-LQ 14Z 22x25 (119.073.3) (328 0377 11) | | |
| Argon Frutetto 60 II 75 II Rock 55, 60 | 280/280 GU6 | 29/200-506 (122.571.4) (228 0133 11) | 280 LG | 29/221-509 UC-LS 20Z 36x40 (122.572.3) (328 0378 11) | 29/230-500 AU (2.2041.008.0) |
| 280 LM | | | 29/212-503 UC-LR 14Z 22x25 (119.067.3) (328 0377 10) | | |
| Ariette | 350/350 SAME | | 350 LG | 29/221-528 UF 24Z 46x50 (263.2313.8) | |
| 350 LG | | | 29/221-510 UF-VZ 24Z 46x50 | | |
| 350 LG | | | 29/221-511 TF-VZ 24Z 46x50 (154.2213.3/10) | | |
| 350 LG | | | 29/221-512 UC-LT 24Z 46x50 | | |
| 350 LM | | | 29/212-504 UF 17Z 28x32 (154.2222.3) | | |
| Aster 60, 70 Suite page suivante <i>Continuation on following page</i> | 280/280 GU6 Valéo | 29/200-507 DV | 280 LG | 29/221-513 UC-LS 20Z 36x40 (328 0017 11) | 29/231-502 50x82 / 90x22 (2.2999.153.0) (500 0459 00) |
| | | | 280 LM | 29/212-505 UF 14Z 22x25 (422.2222.3/20) | |
| | 280/280 GU6 Luk | 29/200-508 DV-AA-AN (228 0040 12) | 280 LG | 29/221-513 UC-LS 20Z 36x40 (328 0017 11) | 29/231-504 70x110x20 29/230-500 AU (2.2041.008.0) |
| | | | 280 LM | 29/212-506 UF 14Z 22x25 (84751.3/10) (328 0318 30) | |

Les références des pièces sont indicatives.
Nos pièces ne sont pas d'origine



"THE RELIABLE SERVICE"



Part numbers are quoted for reference purposes only.
Our parts and accessories are not original.

MECANISMES & DISQUES D'EMBRAYAGE
CLUTCH ASSEMBLIES & PLATES

| Tracteurs Tractors | Embrayage Clutch | | Disque Plate | | Butée de débrayage Release Bearing |
|---|------------------------|--|-----------------|--|---|
| | Ø | N° | Ø | N° | |
| Aster 60, 70 Suite de la page précédente <i>Continuation from the previous page</i> | 280/280 GU6 Luk | 29/200-509 DV (228 0040 13) | 280 LG | 29/221-514 UF 20Z 36x40 (328 0017 16) | 29/231-502 50x82 / 90x22 (2.2999.153.0) (500 0459 00) |
| | | | 280 LM | 29/212-506 UF 14Z 22x25 (84751.3/10) (328 0318 30) | |
| Atlanta 55 | 250/280 SAME | | 250 LK | 29/212-507 UF-VZ 20Z 36x40 (0.146.2222.3/10) | |
| | | | 280 LN | 29/221-515 VZ 10Z 23x29 | |
| Aurora 45 | 230/250 SAME | | 230 LK | 29/212-508 UF 14Z 36x40 | |
| | | | 250 LN | 29/221-516 TF 10Z 21x25 | |
| Buffalo 130 | 350 G3 SAME | | 350 | 29/221-517 UC-MH 24Z 46x50 (212.2359.3/10) (335 0162 30) | 29/231-505 65x102x27 |
| | | | 350 | 29/221-510 UF-VZ 24Z 46x50 | |
| | | | 350 | 29/221-511 TF-VZ 24Z 46x50 (154.2213.3/10) | |
| | | | 350 | 29/221-512 UC-LT 24Z 46x50 | |
| Drago Drago 120 | 350/350 GU6 SAME | | 350 LG | 29/221-528 UF 24Z 46x50 (263.2313.8) | |
| | | | 350 LG | 29/221-510 UF-VZ 24Z 46x50 | |
| | | | 350 LG | 29/221-511 TF-VZ 24Z 46x50 (154.2213.3/10) | |
| | | | 350 LG | 29/221-512 UC-LT 24Z 46x50 | |
| | | | 350 LM | 29/212-504 UF 17Z 28x32 (154.2222.3) | |

Les références des pièces sont indicatives.
Nos pièces ne sont pas d'origine

Part numbers are quoted for reference purposes only.
Our parts and accessories are not original.



"THE RELIABLE SERVICE"



MECANISMES & DISQUES D'EMBRAYAGE
CLUTCH ASSEMBLIES & PLATES

| Tracteurs Tractors | Embrayage Clutch | | Disque Plate | | Butée de débrayage Release Bearing |
|---|------------------------|--|-----------------|--|---|
| | Ø | N° | Ø | N° | |
| Centaurus 60 Export 70 Corsaro 70 | 250/290 G3 SAME | | 250 LK | 29/212-509 UF-VZ 22Z 41x45 (135.2222.3) | |
| | | | 290 LN | 29/221-518 UF-VZ 10Z 23x29 (157.2213.3) | |
| | | | 290 | 29/221-519 UC-VZ 10Z 23x29 | |
| Centurion 75 (nr. 3371⇒) Leone 70, 80 Saturno 80 Mercury 85 | 265/320 GU6 SAME | | 265 LK | 29/212-510 UF-VZ 22Z 41x45 (136.2222.3/10) | |
| | | | 320 LN | 29/221-520 UF-VZ 10Z 23x29 | |
| | | | 320 LN | 29/221-521 TF-VZ 10Z 23x29 | |
| Condor 55 Corsaro 70 /S Falcon 50 Frutteto 60 Minitauro 60 Minitaurus 60 Taurus 60 Vigneron 60 | 250/280 GU6 Luk | 29/200- 510 DF Sans moyeu de commande de pompe hydraulique <i>Less hydraulic pump drive hub</i> (194.2210.4) (228 0067 11) | 250 LK | 29/212-511 UF 20Z 36x40 (194.2222.3) (325 0114 16) | 29/231-505 65x102x27 |
| | | | 250 LK | 29/212-512 VZ 20Z 36x40 | |
| | | | 280 LN | 29/221-523 TF 14Z 22x25 (194.2213.3) (328 0127 16) | |
| | 250 LK | 29/221-524 UF 20Z 36x40 (203.2222.3) | | | |
| | 280 LN | 29/212-513 TF 14Z 22x25 (283.2213.3) (328 0270 36) | | | |
| | 280 LN | 29/221-527 VZ 14Z 22x25 | | | |
| 250/280 GU6 Valéo | | | 250 LK | 29/212-511 UF 20Z 36x40 (194.2222.3) (325 0114 16) | |

Les références des pièces sont indicatives.
Nos pièces ne sont pas d'origine

Part numbers are quoted for reference purposes only.
Our parts and accessories are not original.



"THE RELIABLE SERVICE"



MECANISMES & DISQUES D'EMBRAYAGE
CLUTCH ASSEMBLIES & PLATES

| Tracteurs Tractors | Embrayage Clutch | | Disque Plate | | Butée de débrayage Release Bearing |
|---|--|---|-----------------|---|--|
| | Ø | N° | Ø | N° | |
| Dorado 60, 70 /DT | 310 DF Valéo | 29/200-500 Ø Ext. / Out. 368 mm (008.4293.3) (131 0229 30) | 310 | 29/221-501 TC-LT 24Z 36x40 (008.4292.3) (331 0184 30) | |
| | 310 DF B. & B. | 29/200-501 Ø Ext. / Out. 365 mmm (294.2320.3) (131 0228 50) | 310 | 29/221-502 TF 24Z 36x40 (445.2330.3) (331 0179 36) | |
| Explorer 55, 60, 65 Same 65 | 280 DF Valéo 6 goujons 6 studs | 29/200-511 (255.2320.3/10) (128 0248 30) | 280 | 29/221-526 TF 24Z 36x40 (270.2330.3/10) | 29/231-500 55x91x26 (2.2999.193.0) (500 0076 20) |
| | 280 DF B. & B. 8 goujons 8 studs | 29/200-512 (255.230.3) (128 0243 50) | | | |
| Explorer 70, 75, 80, 90 70 II /DT (⇒ 22091) 90 /DT Spécial / Special 70, 70 II Spécial / Special Basso 70 II 80 II /LP Top 90 II Golden Compatto 75 85 /DT Row Crop 90 /DT (⇒ 1357) | 310 DF Valéo | 29/200-500 Ø Ext. / Out. 368 mm (008.4293.3) (131 0229 30) | 310 | 29/221-501 TC-LT 24Z 36x40 (008.4292.3) (331 0184 30) | |
| | 310 DF B. & B. | 29/200-501 Ø Ext. / Out. 365 mmm (294.2320.3) (131 0228 50) | 310 | 29/221-502 TF 24Z 36x40 (445.2330.3) (331 0179 36) | |
| Explorer 80 II /DT Spécial 80 (⇒ 15592) 80 /LP 80 II /LP 90 (⇒ 2974) 90 /LP (⇒ 1075) Top 90 II Silver 80, 90, 100.4 | 330 DV Valéo | 29/200-502 (008.4184.3) (133 0220 30) | 330 | 29/221-503 TC-LT 24Z 36,5x41 (009.6533.3) (333 0116 30) | 29/231-501 MV lg. 213 mm (2.2999.207.0) (500 0846 30) |
| | | | | 29/221-504 TF 24Z 36,5x41 (008.9937.3) (333 0117 30) | |
| Falcon N°3241⇒ | 250/280 3GU SAME | | 280 LN | 29/221-527 VZ 14Z 22x25 | 29/231-505 65x102x27 |
| | | | 250 LK | 29/212-507 VZ 20Z 36x40 (146.2222.3/10) | |

Les références des pièces sont indicatives.
Nos pièces ne sont pas d'origine



"THE RELIABLE SERVICE"



Part numbers are quoted for reference purposes only.
Our parts and accessories are not original.

MECANISMES & DISQUES D'EMBRAYAGE
CLUTCH ASSEMBLIES & PLATES

| Tracteurs Tractors | Embrayage Clutch | | Disque Plate | | Butée de débrayage Release Bearing | | |
|--|---------------------|--|-----------------|--|---|--|--------------------------------|
| | Ø | N° | Ø | N° | | | |
| Frutetto 60 II, 75 II ⇒ Voir / See Argon | | | | | | | |
| Frutetto 85 II ⇒ Voir / See Argon 60 | | | | | | | |
| Galaxy 170 | 350 DV Valéo | 29/200-513 (269.2310.4) (135 0230 30) | 350 | 29/221-517 UC-MH 24Z 46x50 (212.2359.3/10) (335 0162 30) | | | |
| | 350 SAME | | 350 | | | 29/221-512 UC-LT 24Z 46x50 | |
| | | | 350 | | | 29/221-528 UF 24Z 46x50 (263.2313.8) | |
| | | | 350 | | | 29/221-510 UF 24Z 46x50 | |
| | | | 350 | | | 29/221-511 TF 24Z 46x50 (154.2213.3/10) | |
| Golden Compatto 75, 85 /DT ⇒ Voir / See Explorer | | | | | | | |
| Hercules 160 | 350 DV Valéo | 29/200-513 (269.2310.4) (135 0230 30) | 350 | 29/221-517 UC-MH 24Z 46x50 (212.2359.3/10) (335 0162 30) | | | |
| | 350 SAME | | 350 | | | 29/221-512 UC-LT 24Z 46x50 | |
| | | | 350 | | | 29/221-510 UF 24Z 46x50 | 29/231-505 65x102x27 |
| | | | 350 | | | 29/221-511 TF 24Z 46x50 (154.2313.3/10) | |

Les références des pièces sont indicatives.
Nos pièces ne sont pas d'origine

Part numbers are quoted for reference purposes only.
Our parts and accessories are not original.



"THE RELIABLE SERVICE"



MECANISMES & DISQUES D'EMBRAYAGE
CLUTCH ASSEMBLIES & PLATES

| Tracteurs <i>Tractors</i> | Embrayage <i>Clutch</i> | | Disque <i>Plate</i> | | Butée de débrayage <i>Release Bearing</i> |
|---|---|--|--|---|--|
| | Ø | N° | Ø | N° | |
| Jaguar 95 Léopard 85, 90 Panther 95 | 330 4 doigts + bague d'appui 4 levers + <i>split ring</i> B. & B. | 29/200-514 Volant plat <i>Flat flywheel</i> (176.235.4) (133 0027 50) | 330 | 29/221-529 TF 24Z 46x50 (176.2352.3) | 29/231-505 65x102x27 |
| 325 | | | 29/221-530 TF 24Z 46x50 | | |
| 325 | | | 29/221-531 TC 24Z 46x50 15 paires de pastilles <i>15 pairs of pads</i> | | |
| 325 | | | 29/221-532 TF 24Z 46x50 renforcé / <i>Strengthened</i> | | |
| Jaguar 100 Laser 90, 100, 110 Léopard 90 turbo Tiger 100 Tiger Six 105 | 350 DV Valéo | 29/200-513 (269.2310.4) (135 0230 30) | 350 | 29/221-517 UC-MH 24Z 46x50 212.2359.3/10 (335 162 30) | 29/231-501 MV Lg. 213 mm ⇒20175 (2.2999.207.0) (500 0846 30) |
| 350 | | | 29/221-512 UC-LT 24Z 46x50 | | |
| 350 | | | 29/221-528 UF 24Z 46x50 (263.2313.8) | 29/231-507 Lg. 224 mm 20176⇒ (202.6551.3) Laser 100 Laser 110 (1280⇒) | |
| 350 | | | 29/221-510 UF 24Z 46x50 | | |
| 350 | | | 29/221-511 TF 24Z 46x50 (154.2313.3/10) | | |
| Krypton 80, 90, 100 | 330 DF | 29/200-515 (133 0259 10) | 327 | 29/221-534 TC-LS 24Z 36,5x41,1 (333 0186 10) | |
| Laser 130, 150, 170 Suite page suivante <i>Continuation on following page</i> | 350 DV Valéo | 29/200-516 (212.2358.4/10) | 350 | 29/221-517 UC-MH 24Z 46x50 (212.2359.3/10) (335 0162 30) | 29/231-501 MV Lg. 213 mm (2.2999.207.0) (500 0846 30) |
| 350 | | | 29/221-512 UC-LT 24Z 46x50 | | |
| 350 | | | 29/221-528 UF 24Z 46x50 (263.2313.8) | | |

Les références des pièces sont indicatives.
Nos pièces ne sont pas d'origine



"THE RELIABLE SERVICE"



Part numbers are quoted for reference purposes only.
Our parts and accessories are not original.

MECANISMES & DISQUES D'EMBRAYAGE
CLUTCH ASSEMBLIES & PLATES

| Tracteurs Tractors | Embrayage Clutch | | Disque Plate | | Butée de débrayage Release Bearing |
|--|-------------------------------------|--------------------------------------|----------------------------|--|--|
| | Ø | N° | Ø | N° | |
| Laser 130, 150, 170 Suite de la page précédente <i>Continuation from the previous page</i> | 350 DV Valéo | 29/200-516 (212.2358.4/10) | 350 350 | 29/221-510 UF 24Z 46x50 29/221-511 TF 24Z 46x50 (154.2213.3/10) | 29/231-501 MV Lg. 213 mm (2.2999.207.0) (500 0846 30) |
| Léone 70 ⇒ Voir / See Centurion 75 | | | | | |
| Léopard 85, 90 90T (⇒ 20 174) ⇒ Voir / See Jaguar 95 | | | | | |
| Léopard 90 T (20 175 ⇒) ⇒ Voir / See Jaguar 100 | | | | | |
| Léopard C, 85C Léopard Crawler | 310/310 | | 310 LG 310 LM | 29/221-535 UF 20Z 36x40 (331 0172 36) 29/212-514 UF 14Z 22x25 (331 0171 36) | |
| Mercury 85 ⇒ Voir / See Centurion 75 | | | | | |
| Minitauro 60 Minitaurus 60 ⇒ Voir / See Condor 55 | | | | | |
| Panther | 330 3 doigts 3 levers SAME | | 325 | 29/221-536 TF 23Z 44x48 | |
| Panther 90 ⇒ Voir / See Léopard | | | | | |
| Panther 95 ⇒ Voir / See Jaguar 95 | | | | | |
| Rock 55, 60 ⇒ Voir / See Argon | | | | | |
| Rock 55, 60, 70 ⇒ Voir / See Argon 60 | | | | | |
| Row Crop 90 /DT (⇒1357) ⇒ Voir / See Explorer Top 90 II | | | | | |

Les références des pièces sont indicatives.
Nos pièces ne sont pas d'origine



"THE RELIABLE SERVICE"



Part numbers are quoted for reference purposes only.
Our parts and accessories are not original.

MECANISMES & DISQUES D'EMBRAYAGE
CLUTCH ASSEMBLIES & PLATES

| Tracteurs <i>Tractors</i> | Embrayage <i>Clutch</i> | | Disque <i>Plate</i> | | Butée de débrayage <i>Release Bearing</i> |
|--|-------------------------------------|--|------------------------|--|---|
| | Ø | N° | Ø | N° | |
| Row Crop 90 (1358 ⇒) ⇒ Voir / See Antares 100 | | | | | |
| Same 65 ⇒ Voir / See Explorer 55, 60, 65, 70 | | | | | |
| Saturnsynchro 80 ⇒ Voir / See Centurion 75 (3371⇒) | | | | | |
| Silver 80 (⇒ 2073) Silver 90 (⇒ 2963) Silver 100.4 (⇒ 1874) ⇒ Voir / See Explorer 80 II /DT | | | | | |
| Silver 100.6 (⇒ 3222) ⇒ Voir / See Antares 100 | | | | | |
| Taurus 60 ⇒ Voir / See Condor 55 | | | | | |
| Tiger Six /105 Titan 105, 106 Trident 130 Export | 350 DV Valéo | 29/200-513 (269.2310.4) (135 0230 30) | 350 | 29/221-537 UF 24Z 46x50 (250.2313.3) (335 0163 36) | 29/231-508 MV Lg. 164 mm |
| | 350 3 doigts 3 levers SAME | | 350 | 29/221-517 UC-MH 24Z 46x50 (212.2359.3/10) (335 0162 30) | 29/231-505 65x102x27 |
| | | | 350 | 29/221-512 UC-LT 24Z 46x50 | |
| | | | 350 | 29/221-510 UF 24Z 46x50 | |
| | | | 350 | 29/221-511 TF 24Z 46x50 (154.2213.3/10) | |

AA En option
AN Renforcé
AU Roulement pilote
DF Diaphragme, volant plat
DV Diaphragme, volant creux
G3 3 doigts
GU6 Commande indépendante, 6 doigts
LG Friction d'avancement côté BV, montée
LK Friction prise de force côté BV, montée
LM Friction prise de force côté moteur, libre
LN Friction d'avancement côté moteur, libre
LQ 3 paires de pastilles
LR 4 paires de pastilles
LS 5 paires de pastilles
LT 6 paires de pastilles
MH 7 paires de pastilles
ML 10 paires de pastilles
MV Butée avec support
TC Cera-métallique à ressorts
TF Organique à ressorts
UC Cera-métallique fixe
UF Organique à fixe
VZ Version économique

AA *Optional*
AN *Heavy duty*
AU *Spigot bearing*
DF *Diaphragm, flat flywheel*
DV *Diaphragm, pot flywheel*
G3 *3 levers*
GU6 *Independent clutch, 6 levers*
LG *Main disc, transmission side, mounted*
LK *PTO disc, transmission side, mounted*
LM *PTO disc, engine side, loose*
LN *Main disc, engine side, loose*
LQ *3 pairs of pads*
LR *4 pairs of pads*
LS *5 pairs of pads*
LT *6 pairs of pads*
MH *7 pairs of pads*
ML *10 pairs of pads*
MV *Release bearing with carrier*
TC *Spring cera-metallic*
TF *Spring organic*
UC *Fixed cera-metallic*
UF *Fixed organic*
VZ *Economic version*

Les références des pièces sont indicatives.
Nos pièces ne sont pas d'origine

Part numbers are quoted for reference purposes only.
Our parts and accessories are not original.



MECANISMES & DISQUES D'EMBRAYAGE
CLUTCH ASSEMBLIES & PLATES
LAMBORGHINI

| Tracteurs Tractors | Embrayage Clutch | | Disque Plate | | Butée de débrayage Release Bearing |
|---|-------------------------|---|---|--|--|
| | Ø | N° | Ø | N° | |
| C 65 | 280 DF Valéo | 32/200-511 (128 0248 30) | 280 | 32/221-526 TF 24Z 36x40 (328 0275 36) | |
| C 75 | 310 DF Valéo | 32/200-501 (131 0228 50) | 310 | 32/221-502 TF 24Z 36x40 (331 0179 36) | |
| C 352 | 225/225 GA3 Luk | 32/200-517 (431.2210.4) (223 0007 11) | 225 LG 225 LM | 32/221-540 UF 20Z 36x40 (2.316.746) (323 0035 16) 32/212-515 UF 13Z 19x22 (431.2222.3) (323 0117 16) | |
| R 483 /DT | 250/230 GU6 Valéo | 32/200-518 | 250 LG 230 LM | 32/221-541 20Z 36x40 32/212-516 14Z 22x25 | |
| F 660 Plus /DT F 775 Plus /DT F 880 Plus /DT F 990 Plus /DT | 280/280 GU6 Luk | 32/200-519 (228 0133 10) | 280 LG 280 LM | 32/221-508 UC-LT 20Z 36x40 (328 0378 12) 32/212-517 UC-LQ 14Z 22x25 (328 0377 11) | |
| C 483, R 483, C 503, R 503, C 553, R 553, C 583, R 583, C 603, C 633, C 654, R 654, C 683, R 683, R 724, R 754, R 754 DT, R 824, R 845 DT, R 854, R 854 DT, R 955, 990 (1975⇒) LUK ET / AND VALÉO NON INTERCHANGEABLE NOT INTERCHANGEABLE Suite à la page suivante <i>Continuation on following page</i> | 280/280 GU6 Luk | 32/200-509 (171.2252.4/11) (228 0040 13) | 280 LG 280 LG 250 LM | 32/221-514 UF 20Z 36x40 (422.2261.3) (328 0017 16) 32/221-542 UF 20Z 36x40 32/212-505 UF 14Z 22x25 | 32/231-509 50x94x21 32/231-510 70x110x20 (500 0284 00) |

Les références des pièces sont indicatives.
Nos pièces ne sont pas d'origine

Part numbers are quoted for reference purposes only.
Our parts and accessories are not original.



"THE RELIABLE SERVICE"



MECANISMES & DISQUES D'EMBRAYAGE
CLUTCH ASSEMBLIES & PLATES

| Tracteurs Tractors | Embrayage Clutch | | Disque Plate | | Butée de débrayage Release Bearing |
|---|--|---|--|--|--|
| | Ø | N° | Ø | N° | |
| C 483, R 483, C 503, R 503, C 553, R 553, C 583, R 583, C 603, C 633, C 654, R 654, C 683, R 683, R 724, R 754, R 754 DT, R 824, R 845 DT, R 854, R 854 DT, R 955, 990 (1975⇒) LUK ET / AND VALÉO NON INTERCHANGEABLE NOT INTERCHANGEABLE Suite de la page précédente <i>Continuation from the previous page</i> | 280/280 GU6 Luk | 32/200-508 (171.2250.4) (228 0040 12) | 280 LG | 32/221-513 UC-LS 20Z 36x40 (328 0017 11) | 32/231-509 50x94x21 32/231-510 70x110x20 (500 0284 00) |
| | | | 280 LM | 32/212-506 UF 14Z 22x25 (328 0318 30) | |
| | 280/280 GU6 Valéo | 32/200-520 | 280 LG | 32/221-543 UF 20Z 36x40 | |
| | | | 280 LM | 32/212-505 UF 14Z 22x25 | |
| | 280/280 GU6 Valéo | 32/200-507 | 280 LG | 32/221-513 UC-LS 20Z 36x40 (328 0017 11) | |
| | | | 280 LG | 32/221-544 UF 20Z 36x40 | |
| 280 LM | | | 32/212-506 UF 14Z 22x25 (328 0318 30) | | |
| R 674 (⇒1970) | 280 Diaphr. B. & B 8 goujons 8 studs | 32/200-512 (128 0243 50) | 280 | 32/221-526 TF 24Z 36x40 (328 0275 36) | 32/231-500 55x91x26 (500 0076 20) |
| | | | 280 | 32/221-526 TF 24Z 36x40 (328 0275 36) | |
| C 635, R 573, R 674 | 280 Diaphr. Valéo 6 goujons 6 studs | 32/200-511 (128 0248 30) | 280 | 32/221-526 TF 24Z 36x40 (328 0275 36) | |
| R 704, R 804 | 280/280 GU6 Luk | 32/200-521 (427.2410.4/10) (228 0068 10) | 280 LG | 32/221-545 UC-LT 23Z 44x48 (4.272.851) (328 0093 10) | 32/231-509 50x94x21 32/231-510 70x110x20 (500 0284 00) |
| | | | 280 LM | | |

Les références des pièces sont indicatives.
Nos pièces ne sont pas d'origine



"THE RELIABLE SERVICE"



Part numbers are quoted for reference purposes only.
Our parts and accessories are not original.

MECANISMES & DISQUES D'EMBRAYAGE
CLUTCH ASSEMBLIES & PLATES

| Tracteurs Tractors | Embrayage Clutch | | Disque Plate | | Butée de débrayage Release Bearing |
|--|---------------------------------|--|-----------------|--|--|
| | Ø | N° | Ø | N° | |
| R 704, R 754, R 784, 845 DT, 854 DT, R 955 /DT | 310/310 3 doigts 3 levers | | 310 LG | 32/221-535 UF 20Z 36x40 (331 0172 36) | |
| | Diaphr. Valéo | | 310 LG | 32/221-546 UC-LT 20Z 36x40 | |
| | | | 310 LM | 32/212-514 UF 14Z 22x25 (331 0171 36) | |
| R 774-80 Grand Prix, R 874-90 Grand Prix, R 974-90 Grand Prix | 310 DF Diaphr. B. & B | 32/200-501 Ø Ext. / Out 365 mm (131 0228 50) | 310 | 32/221-501 TC-LT 24Z 36x40 (331 0184 30) | 32/231-500 55x91x26 (500 0076 20) |
| | 310 DF Diaphr. Valéo | 32/200-500 Ø Ext. / Out 368 mm (131 0229 30) | 310 | 32/221-502 TF 24Z 36x40 (331 0179 36) | |
| R 904 | 330/310 GU6 Luk | 32/200-522 (429.2453.4) (233 0004 10) Remplace ancien modèle Walterscheid <i>Replaces old Walterscheid clutch</i> | 330 LG | 32/221-547 UC-LT 23Z 44x48 (429.2451.4) (333 0004 10) | 32/231-511 65x97 (500 0059 10) 32/231-512 75x115x20 (500 0378 00) |
| | | | 310 LM | 32/212-519 UF 16Z 27x30 | |
| | | | 310 LG | 32/221-547 UC-LT 23Z 44x48 (429.2451.4) (333 0004 10) | |
| R 956 /DT R 1056 /DT R 1106 /DT R 1156 /DT R 1256 DT R 1306 /DT R 1356 /DT R 1556 /DT | 350 DV Valéo | 32/200-513 (135 0230 30) | 350 | 32/221-517 UC-MH 24Z 46x50 (212.2359.3/10) (335 0162 30) | 32/231-508 MV Lg. 164 mm |
| | | | 350 | 32/221-510 UF 24Z 46x50 | |
| | | | 350 | 32/221-532 TF 24Z 46x50 | |

 Les références des pièces sont indicatives.
 Nos pièces ne sont pas d'origine

 Part numbers are quoted for reference purposes only.
 Our parts and accessories are not original.

"THE RELIABLE SERVICE"

MECANISMES & DISQUES D'EMBRAYAGE
CLUTCH ASSEMBLIES & PLATES

| Tracteurs Tractors | Embrayage Clutch | | Disque Plate | | Butée de débrayage Release Bearing |
|---|----------------------|--|-----------------------------------|--|--|
| | Ø | N° | Ø | N° | |
| R 1306 Turbo R 1506 Turbo | 350 DV Valéo | 32/200-513 (135 0230 30) | 350 | 32/221-517 UC-MH 24Z 46x50 (212.2359.3/10) (335 0162 30) | 32/231-508 MV lg. 213 mm |
| 350 | | | 32/221-510 UF 24Z 46x50 | | |
| 350 | | | 32/221-532 TF 24Z 46x50 | | |
| R 1706 Turbo | 350 DV Valéo | 32/200-513 (135 0230 30) | 350 | 32/221-517 UC-MH 24Z 46x50 (212.2359.3/10) (335 0162 30) | |
| 350 | | | 32/221-510 UF 24Z 46x50 | | |
| 350 | | | 32/221-532 TF 24Z 46x50 | | |
| Formula 105 | 310 DV Valéo | 32/200-500 Ø Ext. / Out. 368 mm (131 0229 30) | 310 | 32/221-501 TC-LT 24Z 36x40 (331 0184 30) | 32/231-500 55x91x26 (500 0076 20) |
| | 310 DV B. & B. | 32/200-501 Ø Ext. / Out. 365 mm (131 0228 50) | 310 | 32/221-502 TF 24Z 36x40 (331 0179 36) | |
| Formula 105 Formula 115 (⇒ 3129) Formula 125 Formula 135 | 330 DV Valéo | 32/200-502 (133 0220 30) | 330 | 32/221-503 TC-LT 24Z 36,5x41 (333 0116 30) | 32/231-501 MV Lg.213mm (500 0846 30) |
| Formula 135 | 350 DV Luk | 32/200-503 (135 0241 10) | 348 | 32/221-506 TC-LT 21Z 41x45 (335 0186 10) | 32/231-501 MV Lg.213mm (500 0846 30) |
| | 350 Valéo DV | 32/200-513 (135 0230 30) | 350 | 32/221-517 UC-MH 24Z 46x50 (212.2359.3/10) (335 0162 30) | |
| N Cross 674-70 | 310 DF Valéo | 32/200-500 Ø Ext. / Out. 368 mm (131 0229 30) | 310 | 32/221-501 TC-LT 24Z 36x40 (331 0184 30) | 32/231-500 55x91x26 (500 0076 20) |

Les références des pièces sont indicatives.
Nos pièces ne sont pas d'origine



"THE RELIABLE SERVICE"

Part numbers are quoted for reference purposes only.
Our parts and accessories are not original.



MECANISMES & DISQUES D'EMBRAYAGE
CLUTCH ASSEMBLIES & PLATES

| Tracteurs Tractors | Embrayage Clutch | | Disque Plate | | Butée de débrayage Release Bearing |
|--|---------------------|---|-----------------|---|--|
| | Ø | N° | Ø | N° | |
| Premium 150 (⇒ 1433) Premium 160 (⇒ 2077) Premium 850 Premium 950 | 330 DF | 32/200-502 (008.4184.3) (133 0220 30) | 330 | 32/221-503 TC-LT 24Z 36,5x41 (009.6533.3) (333 0116 30) 32/221-504 TF 24Z 36,5x41 (008.9937.3) (333 0117 30) | 32/231-501 MV Lg.213mm (500 0846 30) |
| Sprint 664-60 Sprint 674-70 | 310 DF Valéo | 32/200-500 Ø Ext. / Out. 368mm (131 0229 30) | 310 | 32/221-501 TC-LT 24Z 36x40 (331 0184 30) | 32/231-500 55x91x28 (500 0076 20) |

DF Diaphragme, volant plat
 DV Diaphragme, volant creux
 G3 3 Doigts
 GA6 Commande combinée, 6 doigts
 GU6 Commande indépendante, 6 doigts
 LG Friction d'avancement côté BV, montée
 LM Friction prise de force côté moteur, libre
 LQ 3 paires de pastilles
 LS 5 paires de pastilles
 LT 6 paires de pastilles
 MH 7 paires de pastilles
 MV Butée avec support
 TC Cera-métallique à ressorts
 TF Organique à ressorts
 UC Cera-métallique fixe
 UF Organique fixe

DF Diaphragm, flat flywheel
 DV Diaphragm, pot flywheel
 G3 3 levers
 GA6 Combined clutch, 6 levers
 GU6 Independent clutch, 6 levers
 LG Main disc, transmission side, mounted
 LM PTO disc, engine side, loose
 LQ 3 pairs of pads
 LS 5 pairs of pads
 LT 6 pairs of pads
 MH 7 pairs of pads
 MV Release bearing with carrier
 TC Spring cera-metallic
 TF Spring organic
 UC Fixed cera-metallic
 UF Fixed organic

Les références des pièces sont indicatives.
Nos pièces ne sont pas d'origine

Part numbers are quoted for reference purposes only.
Our parts and accessories are not original.

"THE RELIABLE SERVICE"

MECANISMES & DISQUES D'EMBRAYAGE
CLUTCH ASSEMBLIES & PLATES
HÜRLIMANN

| Tracteurs Tractors | Embrayage Clutch | | Disque Plate | | Butée de débrayage Release Bearing |
|---|---|--|--|---|--|
| | Ø | N° | Ø | N° | |
| H 355, H 360 H 470, H 476 H 480, H 481 LUK ET / AND VALÉO NON INTERCHANGEABLE NOT INTERCHANGEABLE | 280/280 GU6 Luk | 33/200-508 (228 0040 12) | 280 LG | 33/221-513 UC-LS 20Z 36x40 (328 0017 11) | 33/231-509 50x94x21 33/231-510 70x110x20 (500 0284 00) |
| | | | 280 LM | 33/212-518 UF 14Z 22x25 | |
| | ou / or | 280 LM | 33/212-506 UF 14Z 22x25 (328 0318 30) | | |
| | | | 280 LG | 33/221- 548 UF 20Z 36x40 | |
| 280/280 3 doigts 3 levers Diaphr. Valéo | 280 LM | 33/212-518 UF 14Z 22X25 | | | |
| | | 280 LM | 33/212-518 UF 14Z 22X25 | | |
| H 356, H 358, H 466, H 468 | 280 Diaphr. B. & B. 8 goujons 8 studs | 33/200-512 (128 0243 50) | 280 | 33/221-526 TF 24Z 36x40 (328 0275 36) | 33/231-500 55x91x26 (500 0076 20) |
| | ou / or | 280 Diaphr. Valéo 6 goujons 6 studs | | | |
| H 480 | 310/310 3 doigts 3 levers Diaphr. Valéo | | 310 LG | 33/221-546 UC-LT 20Z 36x40 | |
| | | | 310 LM | 33/212-514 UR 14Z 22x25 (331 0171 36) | |
| H 476, H 478, H 488 B. & B. ET / AND VALÉO NON INTERCHANGEABLE NON INTERCHANGEABLE | 310 DF Diaphr. B. & B. | 33/200-501 Ø Ext. / Out. 365 mm (131 0228 50) | 310 | 33/221-501 TC-LT 24Z 36x40 (331 0184 30) | 33/231-500 55x91x26 (500 0076 20) |
| | 310 DF Diaphr. Valéo | 33/200-500 Ø Ext. / Out. 368 mm (131 0229 30) | | | |

Les références des pièces sont indicatives.
Nos pièces ne sont pas d'origine

Part numbers are quoted for reference purposes only.
Our parts and accessories are not original.



MECANISMES & DISQUES D'EMBRAYAGE
CLUTCH ASSEMBLIES & PLATES

| Tracteurs Tractors | Embrayage Clutch | | Disque Plate | | Butée de débrayage Release Bearing |
|---|---------------------|------------------------------------|-----------------|--|--|
| | Ø | N° | Ø | N° | |
| H 490 H496T H5116 H 5160 H 6160 H 6170 | 350 DV Valéo | 33/200-513 (135 0230 30) | 350 350 | 33/221-517 UC-MH 24Z 46x50 (335 0162 30) 33/221-510 UF 24Z 46x50 | 33/231-508 MV Lg. 164 mm |
| H 490 H 5160 H 6160 | 350 Origine | | 350 350 | 33/221-517 UC-MH 24Z 46x50 (335 0162 30) 33/221-510 UF 24Z 46x50 | |
| H 6135 XB Elite | 350 DV LuK | 33/200-503 (135 0241 10) | 348 | 33/221-506 TC-LT 21Z 41x45 (335 0186 10) | 33/231-501 MV Lg.213mm (500 0846 30) |
| XA 607 | 310 DF | 33/200-501 (131 0228 50) | 310 | 33/221-502 TF 24Z 36x40 (331 0179 36) | 33/231-500 55x91x26 (500 0076 20) |
| XT910.6 | 330 DV Valéo | 33/200-502 (133 0220 30) | 330 | 33/221-503 TC-LT 24Z 36,5x41 (333 0116 30) | 33/231-501 MV Lg.213mm (500 0846 30) |
| H6115 XT909 XT910.4 | 330 DV Valéo | 33/200-502 (133 0220 30) | 330 | 33/221-504 TF 24Z 36,5x41 (333 0117 30) | |

DF Diaphragme, volant plat
 DV Diaphragme, volant creux
 GU6 Commande indépendante, 6 doigts
 LG Friction d'avancement côté BV, montée
 LM Friction prise de force côté moteur, libre
 LS 5 paires de pastilles
 LT 6 paires de pastilles
 MH 7 paires de pastilles
 MV Butée avec support
 TC Cera-métallique à ressorts
 TF Organique à ressorts
 UC Cera-métallique fixe
 UF Organique fixe

DF Diaphragm, flat flywheel
 DV Diaphragm, pot flywheel
 GU6 Independent clutch, 6 levers
 LG Main disc, transmission side, mounted
 LM PTO disc, engine side, loose
 LS 5 pairs of pads
 LT 6 pairs of pads
 MH 7 pairs of pads
 MV Release bearing with carrier
 TC Spring cera-metallic
 TF Spring organic
 UC Fixed cera-metallic
 UF Fixed organic

Les références des pièces sont indicatives.
Nos pièces ne sont pas d'origine

Part numbers are quoted for reference purposes only.
Our parts and accessories are not original.



MAITRE CYLINDRE & CYLINDRE RECEPTEUR D'EMBRAYAGES
MASTER & SLAVE CYLINDERS (CLUTCHES)

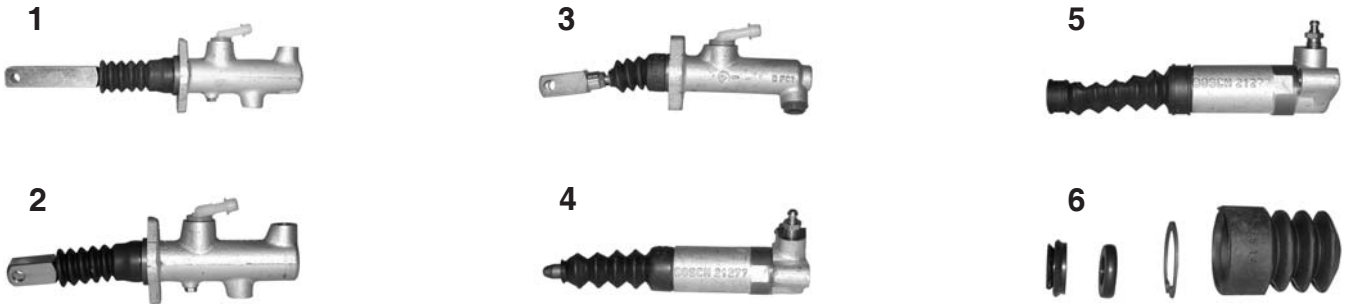

|  | Fig. Fig. | Réf. Ref. | OEM OEM | Désignation Description |
|--|--------------|---------------|-----------------|--|
| Premium 850, 950, 1050, 1060, 1100, 1300 Formula 115, 135 XT908, 909, 910-4, 910-6, 911, 913 Elite XB 6115, 6135 Antares 110, 130 II Row crop 100.6 Silver 80, 90, 100-4, 100-6, 110, 130 | 1 | 29/008-2753 | 0.008.2753.4/10 | Maître cylindre Master cilinder |
| Laser 100, 110, 130, 160 956, 956-100, 1106, 1306, 1506 | 2 | 29/257-6538-4 | 257.6538.4/10 | Maître cylindre Master cilinder |
| 574-60N, 674-70N, 674-70N B, 674-70N, 774-80N Grand prix 674-70, 774-80, 874-90T High clearance 90 Sprint 654-55, 664-60, 664-65, 674-70, 675-75 H358, H468, H478, H484T P, H358-4, H468-4, H468-4B C Prestige H478, H488T H478-4 XA606, XA607, XA655, XA656T, XA657, XA658 Explorer II 60, 70, 80, 90T | 3 | S.255/6538 | 0.255.6538.4/50 | Maître cylindre Master cilinder |
| 574-60N, 674-70N, 674-70N B, 674-70N, 774-80N Grand prix 674-70, 774-80, 874-90T High clearance 90 Premium 850, 950, 1050, 1060, 1100, 1300 Formula 115, 135 Prestige H-358, H468, H-478, H-488T Antares 110, 130 II Explorer 60, 70 Explorer 60, 70, 80 Basso Explorer 80 SKD Explorer 60, 70, 80, 90T Explorer special 70, 80, 90-8 Row crop 90, 100, 100.6 Silver 80, 90, 100-4, 100-6, 110, 130 | 4 | 29/255-6537 | 0.255.6537.4/60 | Cylindre récepteur Slave cilinder |
| 956DT, 956-100, 1106, 1306, 1506 Laser 100, 110, 130, 150 Laser transporter 85 | 5 | S.257/6537 | 0.257.6537.4/40 | Cylindre récepteur Slave cilinder |
| H358, H468, H478, H488T P, H358-4, H468-4, H468-4B C, H478-4 XA606, XA607, XA655, XA656T, XA657, XA658 574-60N, 674-70N, 674-70N B Grand prix 674-70, 774-80, 874-90T 674-70N, 774-80N High clearance 90 Sprint 654-55, 664-60, 664-65, 674-70, 675-75 Explorer II 60, 70, 80, 90T | 6 | 29/255-6538-6 | 0.255.6538.6 | Kit réparation du cyl. récepteur Repair kit of Slave cilinder |
| 956-100, 1106, 1306, 1506 Laser 100, 110, 130, 150 Laser Transporter 85 | 6 | 29/235-6557 | 0.235.6557.6 | Kit réparation du maître cyl. Repair kit of master cilinder |



PIECES DETACHEES POUR EMBRAYAGES VALEO
REPLACEMENT PARTS FOR VALEO CLUTCHES

Embrayage / Clutch 29/M.226 (171.2252.4)

Lamborghini :R.653, 654, 684

Hürlimann : H.355, 360, 470

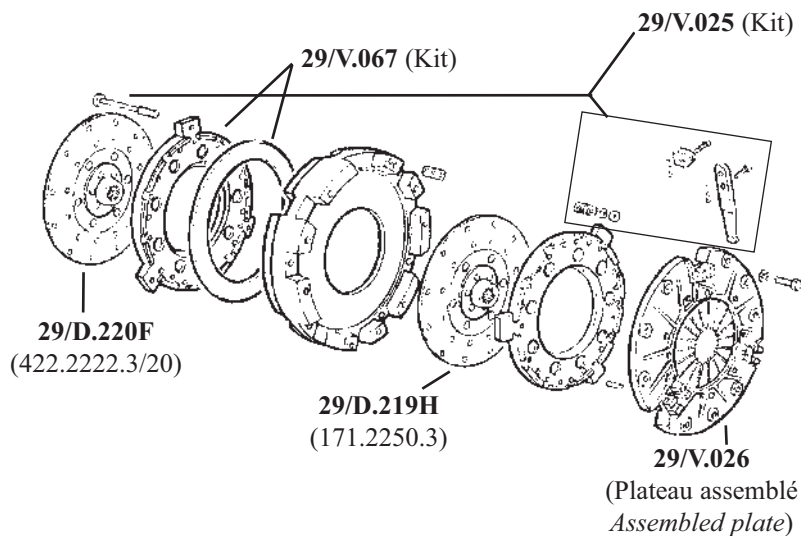

29/V.016 (Kit)

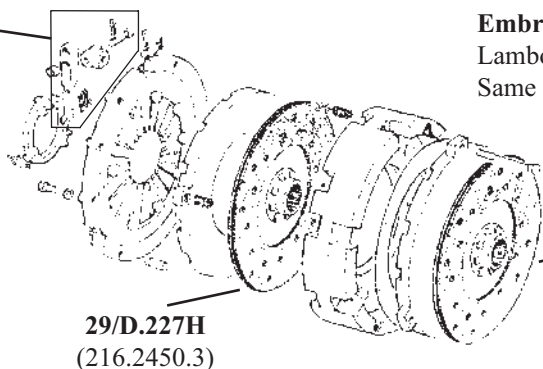

Embrayage / Clutch 29/M.230 (216.2410.4)

Lamborghini :R.784

Same : Leopard C

29/D.227H
(216.2450.3)

Embrayage / Clutch 29/M.229 (195.2210.4)

Lamborghini :R.955, 784

Hürlimann : H.480

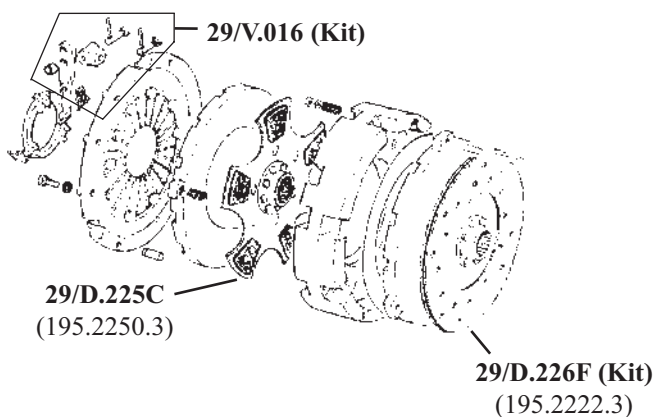

Les références des pièces sont indicatives.
Nos pièces ne sont pas d'origine

Part numbers are quoted for reference purposes only.
Our parts and accessories are not original.



COMMANDE DE PRISE DE FORCE
PTO DRIVE

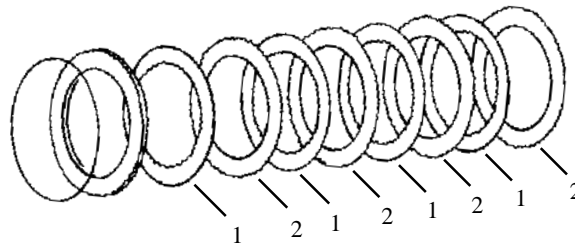

| Tracteurs Tractors | Fig. Fig. | PTO | Dents Teeth |
|---|--------------|-------------|----------------|
| Buffalo 120, 130 Exp., Galaxy170 Turbo, Hercules 160 Exp. | 1 | 29/164-3642 | 45 |
| | 2 | 29/164-3643 | 54 |
| Jaguar 95 Exp., Laser 90, 100, 110, Leopard 85, 90, Panther 95, Tiger 100, Tiger Six 105 Exp. | 1 | 29/163-3654 | 52 |
| | 2 | 29/163-3655 | 60 |
| Explorer 65C, 70C Ergomatic, 75C | 1 | 29/292-5714 | 62 |
| | 2 | 29/292-5715 | 87 |
| Explorer 55, 60, 65 Spécial, 70, 75, 80, 90 | 1 | 29/255-3970 | 48 |
| | 2 | 29/255-3936 | |

ARBRE DE PRISE DE FORCE
PTO SHAFTS

Type long / Long type

S.136/3612 (13636123) Type long - 1 3/8" - 6 cannelures
Long type - 1 3/8" - 6 splines
Centaurio, Centurion, Corsaro, Leone, Drago, Saturno

S.146/3612 (14636123) **NEW** Taurus 60 Export, Minitauro, Falcon, Minitaurus

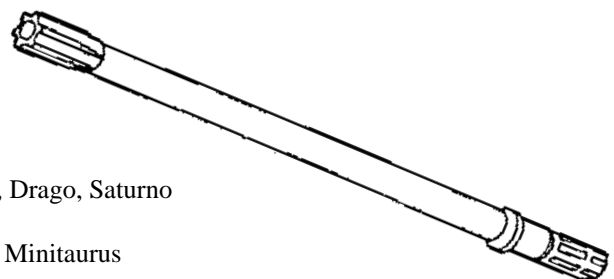

Type à plateau / Plate type

S.167/3660 (16736600/30) 1 3/8" - 6 cannelures / *splines*
Antares 100, 110, 130, Aster 60, 70, Titan 145, 160, Explorer II 60, 70, Leopard,
Jaguar 95, Export, Buffalo 130, Tiger 100, Laser100, 130, Tiger Six 105

S.167/3661 (16736610/20) 1 3/4" - 6 cannelures / *splines*
Buffalo, Tiger 100, Explorer II 60, 70

S.163/3671 (16336710/40) **NEW** 1 3/8" - 21 cannelures / *splines*
Antares 100, 110, 130, Aster 60, 70, Explorer II 60, 70, Laser,
Leopard, Titan, Tiger Six 105, Panther

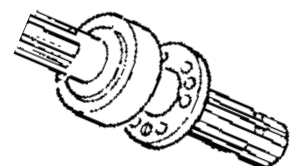

Les références des pièces sont indicatives.
Nos pièces ne sont pas d'origine.

Part numbers are quoted for reference purposes only.
Our parts and accessories are not original.



**FREINAGE
BRAKES**

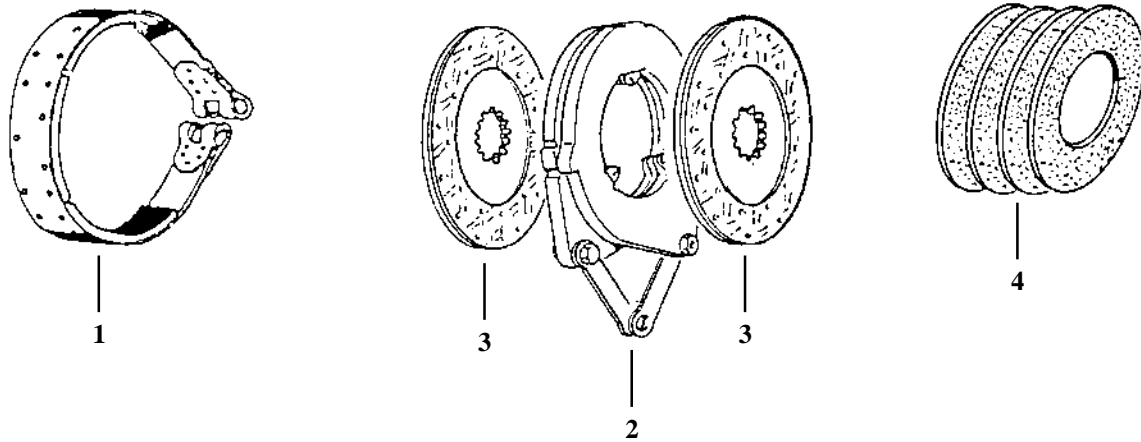

| Tracteurs Tractors | Fig. Fig. | Réf. Ref. | OEM | Ø Ext. (mm) Outer Ø (mm) | Cannelures Splines | Ø cannel. (mm) Splines Ø (mm) |
|--|--------------|--------------|-------------|-----------------------------|-----------------------|----------------------------------|
| FREINS A BANDE / BRAKE BAND | | | | | | |
| Same Centaurus 55, 60, 65 Corsaro 70, 70 synchro | 1 | S.157/5411 | 15754113/10 | 250 | | |
| Same Falcon, Minitauro 50, 55, 60 Frutteto, 60 Vigneto | | S.146/5411 | 14654113/20 | 225 | | |
| FREINS A DISQUES SECS / BRAKE DISCS (DRY) | | | | | | |
| Same Aurora 35,45, Sirenetta Vigneron 35,45, Delfino | 2 | S.159/5432 | 15954323 | 102 | | |
| Lamborghini R235, 235DT, 235S | 3 | S.151/5450 | 15154503 | | 23 | 28x31 |
| Same Centurion 75 Export Condor 55 synchro (↔ N.10000) Corsaro 70, 70 synchro Corsaro Frutteto Minitaurus 60 synchro (↔ 53753) Saturno, Saturno 80 synchro Taurus 60 Export | 2 | S.136/5432K | 13654323 | 178 | | |
| | 3 | S.158/5434 | 15854343 | | 13 | 38 x 44 |
| | 4 | S.136/5435K | 13654350 | | | |
| Lamborghini R483, 483DT (N.1149 ↔) R503, 503DT, R603, 603DT (82 ↔) R583, 583DT, R653, 653DT R654, 654DT, R653 Frutteto R683, 683DT, R684, 684DT R684DT Frutteto, R724, 724DT | 2 | S.136/5432K | 13654323 | | | |
| | 3 | SLT.177/5434 | 17754343 | | 23 | 44 x 48 |
| Hürlimann H345, H355, H360 (↔ N.00626) | 4 | S.136/5435K | 13654350 | | | |

Les références des pièces sont indicatives.
Nos pièces ne sont pas d'origine.

Part numbers are quoted for reference purposes only.
Our parts and accessories are not original.



**FREINAGE
BRAKES**

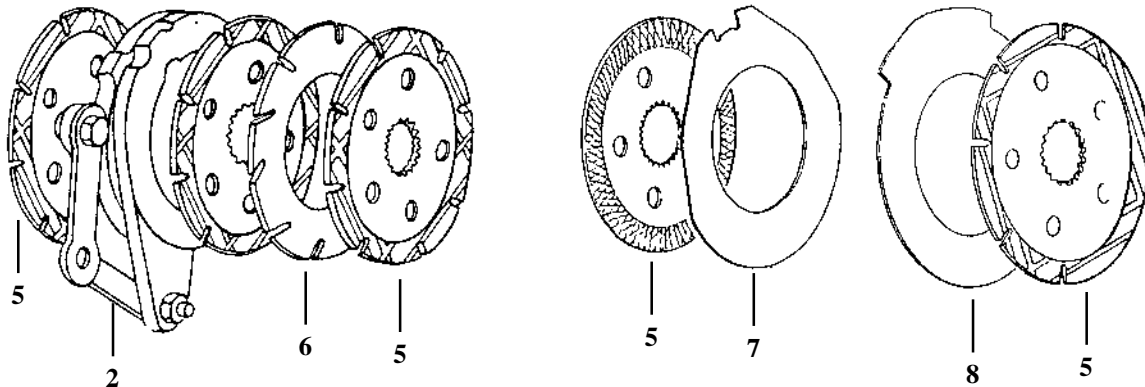

| Tracteurs Tractors | Fig. Fig. | Réf. Ref. | OEM | Ø Ext. (mm) Outer Ø (mm) | Cannelures Splines | Ø cannel. Splines Ø (mm) |
|--|--------------|---------------|-------------|-----------------------------|-----------------------|-----------------------------|
| FREINS A DISQUES SOUS HUILE A COMMANDE MECANIQUE BRAKE DISCS (OIL BATH)(MECHANICAL) | | | | | | |
| Same Buffalo 120, 130 Export Drago 100, 120 Hercules 160 Export (⇔ N.1240) Panther 95 Lamborghini R360, 360DT, R365, 365DT R470, 470DT, R475, 475DT Hürlimann H5160, H6160, H6170T (⇔ N.00161) Roue arrière/Rear wheel | 2 | S.154/5461K | | | | |
| | 5 | S.154/5459 | 15454590 | 224 | 27 | 55 x 61 |
| | 6 | S.154/5460 | 15454600 | 228 | | Ø int./inn 127 |
| Lamborghini R704, 704DT R804, 804DT, R904, 904DT Hürlimann R480, 480DT, R485, 485DT, R490 | 2 | SLT.427/5461K | | | | |
| | 5 | SLT.427/5454 | 42754340 | 224 | 22 | 53 x 60 |
| | 7 | SLT.427/5455 | 42754550 | 228 | | Ø int./inn 127 |
| Same Condor 55 synchro (1001 ⇔) Explorer 60 II & 60 special Minitaurus 60 Frutteto Minitaurus 60 synchro (N.53754 ⇔) | 5 | S.194/5464 | 19454642 | 178 | 13 | 38 x 45 |
| | 8 | S.194/5465 | 19454650 | 184 | | Ø int./inn 125 |
| FREINS A DISQUES SOUS HUILE A COMMANDE HYDRAULIQUE BRAKE DISCS (OIL BATH)(HYDRAULIC) | | | | | | |
| Same Centauro 70 special Centurion 75 special Hercules 160 Export (N.1241 ⇔) Galaxy 170 Turbo Roue arrière/Rear wheel Mercury 85 special Hürlimann H6130, H5160, H6160, H6170T (N.00162 ⇔) Roue arrière/Rear wheel | 5 | S.154/5459 | 15454590/10 | 224 | 27 | 55 x 61 |
| | 6 | S.154/5460 | 15454600/10 | 228 | | Ø int./inn 127 |

Les références des pièces sont indicatives.
Nos pièces ne sont pas d'origine.

Part numbers are quoted for reference purposes only.
Our parts and accessories are not original.

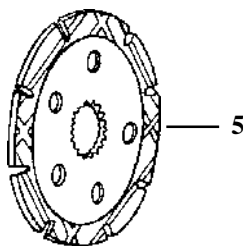

FREINAGE
BRAKES

| Tracteurs Tractors | Fig. Fig. | Réf. Ref. | OEM | Ø Ext. (mm) Outer Ø (mm) | Cannel. Splines | Ø cannel. (mm) Splines Ø (mm) |
|--|--------------|--------------------|-------------------------|-----------------------------|--------------------|----------------------------------|
| FREINS A DISQUES SOUS HUILE / BRAKE DISCS (OIL BATH) | | | | | | |
| Same (Roue arrière / <i>Rear wheels</i>) Jaguar 95 Export Laser 90, 100, 110, 130, 150T Leopard 85 Export, 90 Turbo Tiger 100, Tiger Six 105 Export Trident 130 Export Titan 145, 160, 190 | 5 | S.170/5434 | 17054340 | 304 | 12 | 51 x 68 |
| Lamborghini (Roue arrière / <i>Rear wheels</i>) R956, R956-100, R1106 R1056, R1306 Turbo DT, R1356DT R1506DT Turbo, A1556 DT | | | | | | |
| Hürlimann (Roue arrière / <i>Rear wheels</i>) H490, H496T, H5110 H6136, H6165 Master, H6190 Master | | | | | | |
| Same (Roue arrière / <i>Rear wheels</i>) Explorer 55, 60 Explorer 60 II, 60 Special, 65, 65 Special 70 II, 70 Special, 70 II Special | 5 | 29/255-5447 | 25554472/10 | 282 | 13 | 46 x 59 |
| Lamborghini (Roue arrière / <i>Rear wheels</i>) R573-60N, R574-60N, R674, R674-5 R674-70N, R674-70 Grand Prix | | | | | | |
| Hürlimann (Roue arrière / <i>Rear wheels</i>) H356, H358, H358-4 Club H358 Prestige, H466, H468 | | | | | | |
| Same (Roue arrière / <i>Rear wheels</i>) Explorer 75, 80II, 80 Special, 80 II Special 90 II Turbo Silver 80, 90, 100-4, 100-6 | 5 | 29/445-5447 | 44554472/10 00970672 | 282 | 12 | 46 x 59 |
| Lamborghini (Roue arrière / <i>Rear wheels</i>) R774, 774DT, 774-5, 774-80, 774-80N 774-80 Grand Prix, 874 Turbo 874-90T Grand Prix, 674-70 Grand Prix Premium 850, 950, 1050, 1060 | | | | | | |
| Hürlimann (Roue arrière / <i>Rear wheels</i>) H476, H478, H486, H488 H6115 Elite, H6135 Elite | | | | | | |

Les références des pièces sont indicatives.
 Nos pièces ne sont pas d'origine.

Part numbers are quoted for reference purposes only.
 Our parts and accessories are not original.



**FREINAGE
BRAKES**

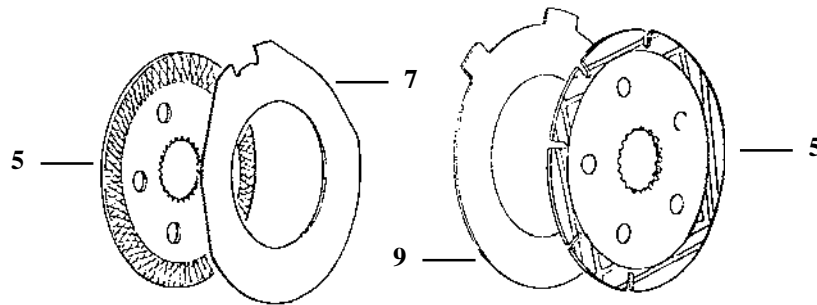

| Tracteurs Tractors | Fig. Fig. | Réf. Ref. | OEM | Ø Ext. (mm) Outer Ø (mm) | Cannel. Splines | Ø cannel. mm Splines Ø (mm) |
|---|--------------|--------------|-------------------------|-----------------------------|--------------------|--------------------------------|
| FREINS A DISQUES SOUS HUILE / BRAKE DISCS (OIL BATH) | | | | | | |
| Same Frutteto 60, 75, Solar 50, 60, Vigneron 75 | 5 | SLT.256/5434 | 25654340/10 25654340 | 178 | 23 | 44 x 48 |
| Lamborghini R483, 483DT, R550, 550DT, R583, 583DT, R653, 653DT, R654, 654DT, R653 Frutteto, R683, 683DT, R684, 684DT, R684 Frutteto, R724, 724DT, 660, 660DT, 660F, 660V, 775, 775F | 7 | SLT.256/5436 | 25654560 17754750 | 184 | | Ø int./inn 114 |
| Hürlimann H351, H355F, H360 (N.00811⚡) H470 (N. 00627⚡), H361, H476F | | | | | | |
| Lamborghini R1156, R1256 | | SLT.188/5434 | 18854340 | 342 | | 58 x 83 |
| Lamborghini R754, 754DT, R955, 955DT R784, 784DT, R854, 854DT | | SLT.171/5434 | 17154342 | 260 | 12 | 51 x 68 |
| Hürlimann H480 | 5 | | | | | |
| Same (Roue avant / Front whell) Centauro Export, Centurion 75 Special Explorer 65, 65 Special & 70 II Explorer 75, 80 II, 80 Special, 80 II Special Galaxy 170 Turbo, Laser 90, 100, 110, 130, 150T Silver 80, 90, 100-4, 100-6, Antares 100, 110, 130 Titan 145, 160, 190 | | S.224/5434 | 22454340 | 224 | 27 | 55 x 61 |
| Lamborghini (Roue avant / Front whell) R774, 674, R956, R956-100, R1106, R1106DT R1306 Turbo DT, R1356DT, R1506 Turbo DT R1556DT, R1706 Turbo DT, Formula 115, 135, Grand Prix 674-90, 774-80, Grand Prix 874-90T Premium 850, 950, 1050, 1060 Racing 150, 165, 190 | 9 | S.275/4351 | 27543510 | 228 | | Ø int. /inn 140 |
| Hürlimann (Roue avant / Front whell) H496T, H466, 468, 476, 478, 486, 488 H6136, H6115 Elite, H6135 Elite H6165 Master, H6190 Master | | | | | | |
| Hürlimann H5160, 6160, 6170T (Roue avant & arrière/ Front & rear whell) | | | | | | |

Les références des pièces sont indicatives.
Nos pièces ne sont pas d'origine.

Part numbers are quoted for reference purposes only.
Our parts and accessories are not original.



**FREINAGE
BRAKES**

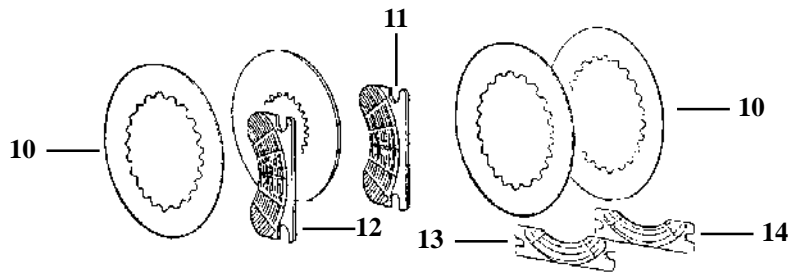

| Tracteurs Tractors | Fig. Fig. | Réf. Ref. | OEM | Ø Ext. (mm) Outer Ø (mm) | Cannelures Splines | Ø cannel. (mm) Splines Ø (mm) |
|---|--------------|--------------|-------------|-----------------------------|-----------------------|----------------------------------|
| FREINS DE STATIONNEMENT / HANDBRAKE DISCS | | | | | | |
| Lamborghini R573, R574, R674 R674-70 Grand Prix, R774, R874 774-80, 874-90T Premium 850, 950 | 10 | 29/255-5452 | 25554520 | 150 | 19 | 59 x 68 |
| | 11 | 29/224-5451 | 17154512 | Simple Singles | | |
| | 12 | 29/224-5459 | 17154592 | Double Double | | |
| Same Jaguar95 Export (N.5131 ⇄) Laser 90, 100, 110, 130, 150 Turbo Leopard 90 Turbo, Tiger 100 Tiger Six 105 Export, Trident 130 Export | 10 | S.188/5458 | 18854580 | 185 | 26 | 64 x 70 |
| | 11 | 29/224-5451 | 17154512 | Simple Singles | | |
| | 12 | 29/224-5459 | 17154592 | Double Double | | |
| Lamborghini R956, R1106, R1056, R1256, R1156, R1306, R1356, R1506, R1556 | 10 | S.171/5457 | 17154570 | 170 | 26 | 64 x 70 |
| | 11 | 29/224-5451 | 17154512 | Simple Singles | | |
| | 12 | 29/224-5459 | 17154592 | Double Double | | |
| Hürlimann H355, H360, H470, H480 | 10 | S.171/5457 | 17154570 | 170 | 26 | 64 x 70 |
| | 11 | 29/224-5451 | 17154512 | Simple Singles | | |
| | 12 | 29/224-5459 | 17154592 | Double Double | | |
| Same Antares 100, 110, 130, Aster 60, 70 | 11 | 29/224-5451 | 17154512 | Simple Singles | | |
| | 12 | 29/224-5459 | 17154592 | Double Double | | |
| | 10 | 29/224-5464 | 22454640/20 | 165 | 25 | 104 x 115 |
| Lamborghini Formula 115, 135 Plus 660F, 775F, 880F 990F Premium 1050, 1060 | 11 | 29/224-5451 | 17154512 | Simple Singles | | |
| | 12 | 29/224-5459 | 17154592 | Double Double | | |
| | 13 | 29/224-5458 | 22454580/10 | Simple Singles | | |
| Hürlimann H6115 Elite, H6135 Elite | 14 | 29/224-5465 | 22454650/10 | Double Double | | |
| | 10 | 29/224-5464 | 22454640/20 | 165 | 25 | 104 x 115 |
| Same Centauro 70 Export, 70 Special Centurion 75 Special Mercury 85 Export, 85 Special | 13 | 29/224-5458 | 22454580/10 | Simple Singles | | |
| | 14 | 29/224-5465 | 22454650/10 | Double Double | | |
| | 10 | 29/224-5464 | 22454640/20 | 165 | 25 | 104 x 115 |

Les références des pièces sont indicatives.
Nos pièces ne sont pas d'origine.

Part numbers are quoted for reference purposes only.
Our parts and accessories are not original.



**FREINAGE
BRAKES**

**MAITRE CYLINDRES DE FREIN
MASTER CYLINDER (BRAKE)**

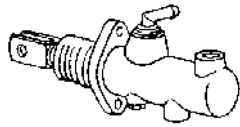

| Tracteurs Tractors | Emetteur Master | Kit réparation Repair Kit |
|--|---------------------|------------------------------|
| Antares | 29/008-2190 (x2) | |
| Explorer Laser | 29/257-6638 (x2) | |
| Centauro Jaguar Leopard Panther Tiger, Tiger Six | S.169/6665 | 29/169-6665 |

**CABLES DE FREIN
BRAKE CABLES**

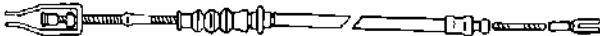

| | | |
|--------------------------|--------------|-----------|
| S.170/6670 | Lg. : 1005mm | Tiger |
| S.174/6650 | Lg. : 560mm | Buffalo |
| 29/202-6625 | Lg. : 760mm | Tiger Six |
| S.264/6636 (26466360) | Lg. : 825mm | Laser |

**RESERVOIR HUILE DE FREIN
OIL BRAKE TANK**

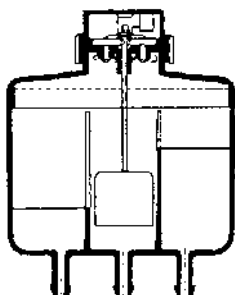

S.257/6654
(25766544/10)

Antares 100, 110, 130
Laser 110
Explorer II 60, 70, 80, 90

**GOUJONS & ECROUS DE ROUES
STUDS & NUT WHEEL**

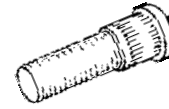

| | |
|-------------|--|
| S.135/4737A | Ø 20x52mm Ariete, Drago, Panther, ... H456 |
| S.1011/311 | Ecrou dito Nut for dito |
| S.146/4737X | Ø 16x37mm Minitauro, Minitaurus, Taurus |
| S.1099/016 | Ecrou dito Nut for dito |
| S.148/4737 | Ø 20x64mm Corsaro, Centurion, Leopard, Tiger, Saturno, ... |
| S.1011/311 | Ecrou dito Nut for dito |

**VIS DE ROUES AVANTS
SCREWS (FRONT WHEEL)**

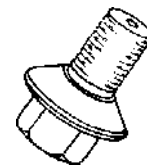

| | |
|-----------|---|
| S.399/003 | Ø 20x25mm Suivant montage 2 & 4 RM Some applications 2 & 4 WD |
| S.399/018 | Ø 18x19mm Suivant montage 2 & 4 RM Some applications 2 & 4 WD |
| S.399/020 | Ø 16x16mm Suivant montage 2 & 4 RM Some applications 2 & 4 WD |

Les références des pièces sont indicatives.
Nos pièces ne sont pas d'origine.

Part numbers are quoted for reference purposes only.
Our parts and accessories are not original.



TRANSMISSION
TRANSMISSION

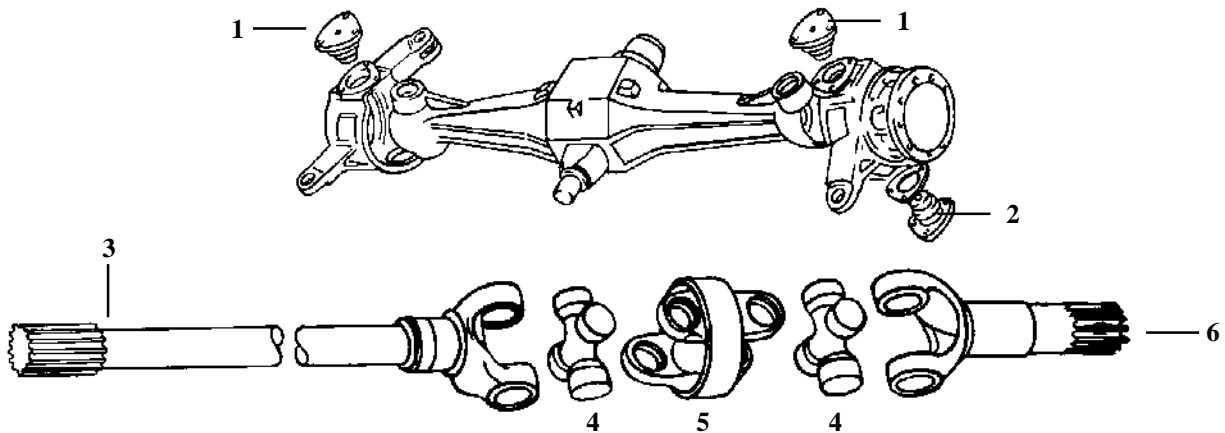

| Tracteurs Tractors | Fig. Fig. | Référence Reference | | Ø mm Ø mm | OEM |
|---|--------------|------------------------|------------|--------------|-------------|
| Saturno, Minitauro, Falcon | 1 | S.135/4335 | NEW | | 13543350 |
| Drago, Buffalo, Panther | 2 | S.135/4367 | NEW | | 13543670 |
| | | S.148/4337 | | | 14843370/10 |
| Saturno, Mercury, Centurion, Leopard, Corsaro | 3 | S.135/4630 | NEW | | 13546300/20 |
| Taurus, Minitauro, Minitaurus, Falcon | | S.146/4630 | | 14646300/20 | |
| Jaguar, Panther | | S.148/4630 | | 14846300/10 | |
| Trident 130, Drago, Buffalo, Tiger 100, Tiger Six 105 | | S.154/4630 | | | 15446300/10 |
| Falcon, Minitaurus, Minitauro, Taurus, Explorer, Aurora, Titan, Aster, Antares 110, 130 Hürlimann : H.360 | | S.146/4632 | | 23,8x61 | 14646326/10 |
| Saturno, Trident 130, Mercury, Drago, Centurion, Leopard, Jaguar, Buffalo, Panther, Aurora, Corsaro, Tiger 100, Tiger Six 105 | 4 | S.150/4632 | | 27x82 | 15046326/20 |
| Laser | | 29/258.4632 | | 30,2x92 | 2584632/10 |
| Titan | | S.212/4632 | | 30,5x107 | 2124632/10 |
| Mercury, Leopard, Jaguar, Panther, Corsaro | 5 | S.135/4633 | NEW | | 13546330/05 |
| Taurus, Minitauro, Minitaurus, Falcon | | S.146/4633 | | 14646330 | |
| Aurora, Tiger 100, Buffalo, Trident, Explorer II, Antares 100, Drago, Tiger Six 105 Lamborghini : 774, 874 | | S.150/4633 | | 15046330/10 | |
| Aster 60, 70 | | S.270/4633 | | 27046330/20 | |
| Saturno, Corsaro | 6 | S.135/4634 | NEW | Z = 17 | 13546340/08 |
| Saturno, Mercury, Centurion, Leopard, Corsaro | | S.136/4634 | | Z = 16 | 13646340/20 |
| Taurus, Minitaurus, Falcon | | S.146/4634 | | | 14646340/30 |
| Drago | | S.154/4634 | | Z = 13 | 15446340/06 |
| Buffalo, Tiger, Tiger Six 105, Tiger 100 | | S.164/4634A | | Z = 12 | 16446340/02 |

Les références des pièces sont indicatives.
Nos pièces ne sont pas d'origine.

Part numbers are quoted for reference purposes only.
Our parts and accessories are not original.



FLASQUE & MANCHONS CANNELES
FLANGE & SPLINED AXLES

S.135/2620
(13526200)

Flasque / Flange
Saturno, Mercury 85 Export,
Centurion 75 Export, Taurus Export 60,
Minitauro, Minitaurus 60 Synchro,
Corsaro 70 Synchro, Falcon, Aurora

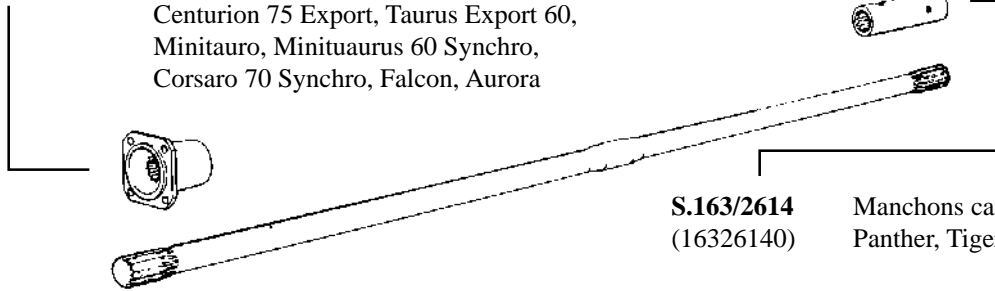

S.163/2614
(16326140)

Manchons cannelés / Splined axles
Panther, Tiger 100, Laser, Tiger Six 105

S.255/2617
(25526170)

Explorer, Explorer II, Antares
Lamborghini 674, 774, 874

KITS DE DIRECTION ASSISTEE
POWER STEERING KITS

SAME

- | | |
|--------|--|
| DA.180 | ATLANTA 45 DT |
| DA.181 | DELFINO 2 RM, SIRENETTA 2 RM |
| DA.182 | FALCON 2 RM |
| DA.183 | FALCON 4 RM - (A) |
| DA.184 | FALCON 4 RM - (A) |
| DA.185 | DELFINO 4 RM |
| DA.186 | RANGER, AURORA 2 RM |
| DA.187 | RANGER, AURORA 4 RM - (A) |
| DA.188 | CORSARO, SATURNO 2 RM |
| DA.189 | CORSARO, SATURNO 4 RM |
| DA.190 | CORSARO, SATURNO 2 RM SYNCHRO |
| DA.191 | CORSARO, SATURNO 4 RM SYNCHRO |
| DA.192 | CORSARO, SATURNO 4 RM - (A) |
| DA.193 | CORSARO, SATURNO 4 RM SYNCHRO - (A) |
| DA.194 | MINITAURO 2 RM |
| DA.195 | MINITAURO 4 RM |
| DA.196 | MINITAURUS, CONDOR 2 RM SYNCHRO |
| DA.197 | MINITAURUS 4 RM SYNCHRO |
| DA.198 | MINITAURO 4 RM - (A) |
| DA.199 | MINITAURUS 4 RM SYNCHRO - (A) |
| DA.062 | LEONE, CENTAURO 2 RM |
| DA.200 | LEONE, CENTAURO 4 RM |
| DA.201 | LEONE, CENTAURO 4 RM - (A) |
| DA.202 | BUFALO, PANTHER, DRAGO, 4 RM |
| DA.203 | BUFALO, PANTHER, DRAGO - (A) |
| DA.204 | SOLAR 50 2 RM |
| DA.205 | SOLAR 60 2 RM |

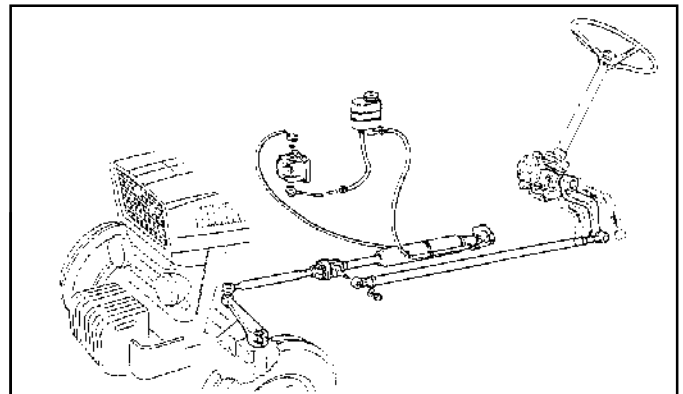

LAMBORGHINI

- | | |
|--------|----------------------------|
| DA.150 | R 475 - 485 - 804 - 704 |
| DA.151 | 503 DT - 305 DT - 503 DT-B |
| DA.152 | 503 DT/DTB - (A) |
| DA.153 | 603 DT/DTB - (A) |
| DA.154 | 603 |
| DA.155 | 603 DT |
| DA.156 | 603 DT-B |
| DA.157 | 483 DT |
| DA.158 | 654 |
| DA.159 | 654 DT |
| DA.160 | 354 |
| DA.161 | 660 |

Ces kits sont fournis avec toutes les pièces nécessaires au montage.
These kits are supplied with all parts needed for installation.
(A) Hydrostatique / Hydrostatic

KIT DE RECONDITIONNEMENT DU FILETAGE DES FUSEES DE ROUES AVANT
FRONT SPINDLE THREAD REPAIR KIT

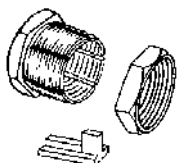

70/457-9 (Ex : LN.10-24M)

Filetage/ Thread 24 x 150mm

L'écrou cône intérieur se visse sur le filetage usé et est serré par l'écrou extérieur.
The inner cone nut is screwed on the worn thread and is locked by the outer nut.

Les références des pièces sont indicatives.
Nos pièces ne sont pas d'origine.

Part numbers are quoted for reference purposes only.
Our parts and accessories are not original.



ROTULES & TIRANTS DE DIRECTION
STEERING LINKS & SOCKETS

POSITIONS

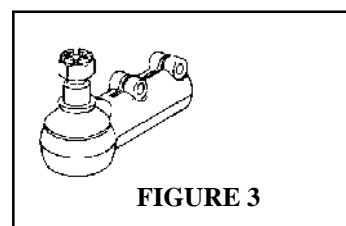
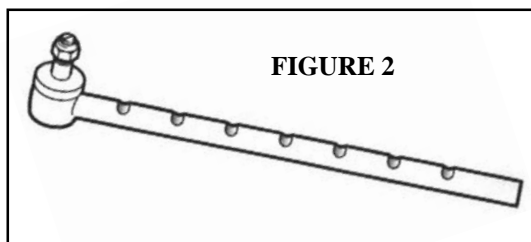
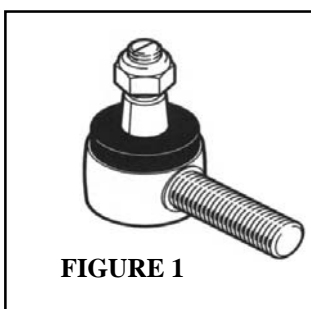
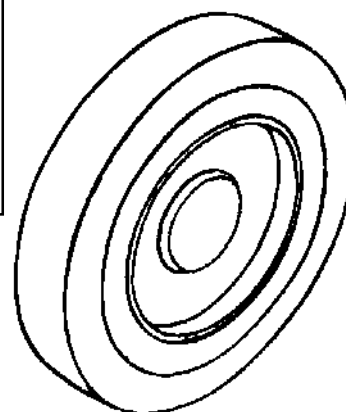
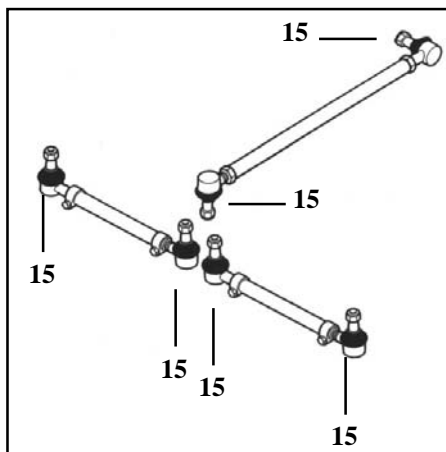
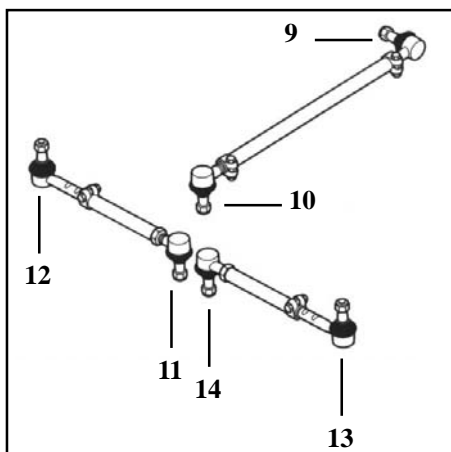
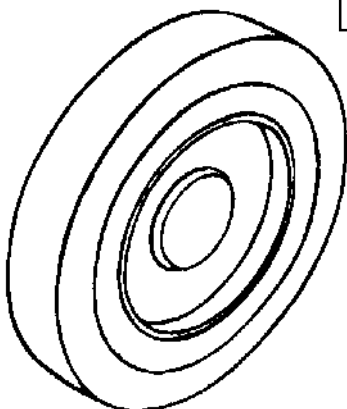
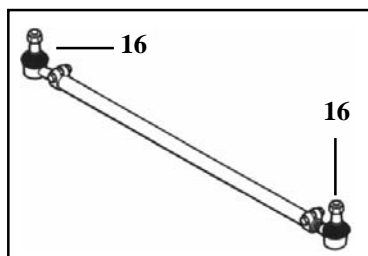
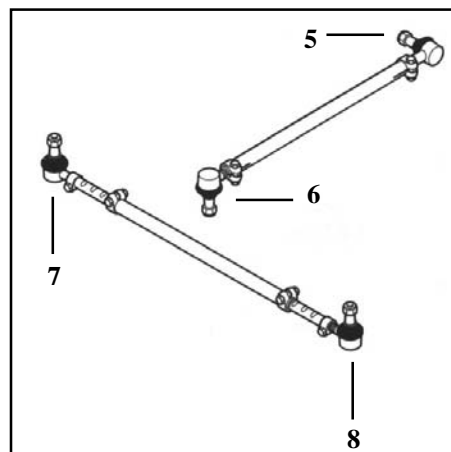
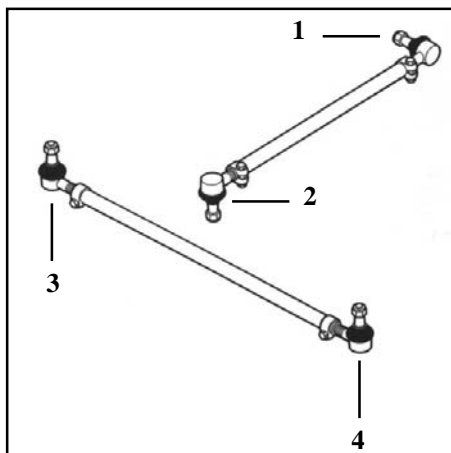

Les références des pièces sont indicatives.
Nos pièces ne sont pas d'origine.

Part numbers are quoted for reference purposes only.
Our parts and accessories are not original.



ROTULES & TIRANTS DE DIRECTION
STEERING LINKS & SOCKETS

Figures & position : consultez la planche de travail page SLH-66 / See page SLH-66 for figures & position

| Tracteurs Tractors | Fig. Fig. | Position Position | Filetage ou Ø Thread or Ø | Longueur Length | Conicité Cone | |
|--|--------------|----------------------|------------------------------|--------------------|------------------|---------|
| Italia DT, Atlanta DT | 1 | 1 | M18 x 1,5 | 100mm | 16/18 | |
| | | 2 | | | | |
| | | 3 | | | | |
| | | 4 | | | | |
| Italia Vigneto DT Atlanta Vigneto DT | | 1 | | M18 x 1,5 | 90mm | 14/16,5 |
| | | 2 | | | | |
| | | 3 | | | | |
| | | 4 | | | | |
| Taurus 60 Minitauro DT Panther Falcon DT Condor DT | | 1 | M18 x 1,5 | 100mm | 16/18 | |
| | | 2 | | | | |
| | | 3 | | | | |
| | | 4 | | | | |
| Solar 50 Solar 60 | | 3 | M24 x 1,5 | 105mm | 18/20 | |
| | | 4 | | | | |
| Solar 50DT Solar 60DT | | 1 | M18 x 1,5 | 100mm | 16/18 | |
| | | 2 | | | | |
| Drago Buffalo | 3 | M24 x 1,5 | 105mm | 18/20 | | |
| | 4 | | | | | |
| | 3 | | | | | |
| | 4 | | | | | |
| Tiger Six 105DT | 1 | M22 x 1,5 | 100mm | 18/20 | | |
| | 2 | | | | | |
| | 3 | | | | | |
| | 4 | | | | | |
| Aurora DT, Delfino DT Sirenetta DT, Ranger 45DT Falcon, Minitauro, Vigneron DT Frutteto DT, Condor Vigneron 35, 45, 60 | 5 | M18 x 1,5 | 16/18 | | | |
| | 6 | | | | | |
| | 7 | M16 x 1,5 | 90mm | 14/16 | | |
| | 8 | | | | | |
| Corsaro Drago Saturno Leopard | 5 | M22 x 1,5 | 100mm | 16/18 | | |
| | 6 | | | | | |
| | 7 | | | | | |
| | 8 | | | | | |
| Aurora Minitaurus Taurus Italia 35 Atlanta | 5 | M18 x 1,5 | 16/18 | | | |
| | 6 | | | | | |
| | 7 | M14 x 1,5 | 75mm | 11/12,5 | | |
| | 8 | | | | | |

 Les références des pièces sont indicatives.
 Nos pièces ne sont pas d'origine.

 Part numbers are quoted for reference purposes only.
 Our parts and accessories are not original.

ROTULES & TIRANTS DE DIRECTION
STEERING LINKS & SOCKETS

Figures & position : consultez la planche de travail page SLH-66 / See page SLH-66 for figures & position

| Tracteurs Tractors | Fig. Fig. | | Position Position | Filetage ou Ø Thread or Ø | Longueur Length | Conicité Cone | |
|---|--------------------------|---------------------------|----------------------|------------------------------|--------------------|--------------------------|-----------|
| Ariete | 1 | S.135/4237 (13542374) | 9 | M18 x 1,5 | 100mm | 16/18 | |
| | | | 10 | | | | |
| Centaurus 55, 65, 70 Leone 70, 75 | | S.135/4345 (13543454) | 9 | M22 x 1,5 | | | |
| | | | 10 | | | | |
| | S.135/4237 (13542374) | 11 | M18 x 1,5 | | | | |
| Centaurus DT, Leone DT Corsaro DT, Saturno DT | 2 | S.135/4234 (13542343) | 12 | Ø 20mm | 300mm | 16/18 | |
| | | | 13 | | | | |
| Drago DT, Buffalo DT, Panther DT | 1 | S.135/4237 (13542374) | 14 | M18 x 1,5 | 100mm | | |
| | | | 15 | | | | M22 x 1,5 |
| Leopard 90, Hercules DT, Leopard DT Leopard 90 Turbo, Taurus 60 DT Tiger DT, Jaguar DT, Explorer 50 Explorer 60, 65, 70 Export Explorer 65, 75, 80 Speed Frutteto 60-75 Aster 60, 70 (4RM/4WD) Antares 100 (4RM / 4WD) Antares 110, 130 (2RM / 2WD) Centurion 75 Export (+ DT) Laser 90, 100, 110 (2RM / 2WD) Explorer II 60, 70, 80, 90 (4RM / 4WD) | 1 | S.148/6126 (14861264) | 16 | M24 x 1,5 | 105mm | 18/20 | |
| | | | | | | 20/22 | |
| Laser 90, 100, 110, 130, 150 (4RM / 4WD) Galaxy 170 (4RM / 4WD) Titan 145, 160, 190 (4RM / 4WD) | 1 | 29/257/4345 (25743454) | | M24 x 1,5 | 100mm | 16/18 | |
| Aster 60, 70 (2RM / 2WD) | | | | | | S.135/4237 (13542374) | M18 x 1,5 |
| Antares 100 (2RM / 2WD) Explorer II, 60, 70, 80, 90 (2RM / 2WD) | 1 | S.135/4345 (13543454) | | M22 x 1,5 | 100mm | 16/18 | |
| | | | | | | 27/1730HU | M22x1,5 |
| Hürlimann Suivant applications Some applications | 3 | 27/1731HU | | M24x1,5 | 145mm | 18/20 | |
| | | | | | | 27/1732HU | M24x1,5 |
| | | | | | | 27/1733HU | F36x1,5 |
| Lamborghini R.754, R.854 | 1 | S.135/4345 (13543454) | 1 | M22 x 1,5 | 100mm | 16/18 | |
| | | | 2 | | | | |
| | | S.135/4237 (13542374) | 3 | M18 x 1,5 | | | |
| | | | 4 | | | | |

 Les références des pièces sont indicatives.
 Nos pièces ne sont pas d'origine.

 Part numbers are quoted for reference purposes only.
 Our parts and accessories are not original.

ROTULES & TIRANTS DE DIRECTION
STEERING LINKS & SOCKETS

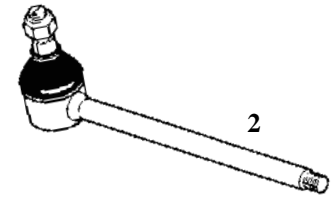
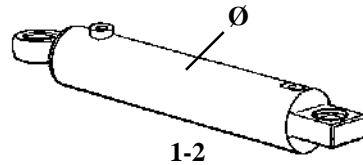
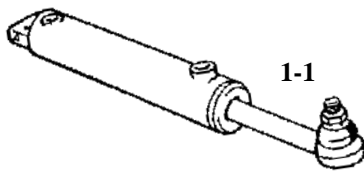

| Figures | 1 | | 2 | | Jeu réparation du vérin Ram cylinder repair kit |
|---|--|----------------------------------|-----------------------------------|------------------------------------|--|
| Tracteurs Tractors | Vérin Ram cylinder | Remarques Comments | Tirant Rod | Remarques Comments | |
| Same Jaguar 95, Tiger 100, Leopard 90 Tiger Six 105, Falcon Lamborghini Hürlimann : H.480, H.490 | S.169/6352 (16963524) 1-1 | A : 215 B : 380 C : 24/26 | S.169/6376 (16963763) | E : 340mm Ø : 22mm C : 24/26 | S.169/6378 (16963786) |
| Same Leopard 85, Centurion 75, Centauro, Mercury DT Lamborghini : R.754, R.654 | S.176/6354 (17663544) 1-1 | A : 215 B : 390 C : 20/22 | S.176/6360 (17663603) | E : 340mm Ø : 22mm C : 20/22 | S.176/6365 (17663656) |
| Same Minitaurus 60, Condor 55 Taurus 60 | S.193/6362 (19363624) 1-1 | A : 170 B : 340 C : 20/22 | S.193/6360A (19363693) | E : 290mm Ø : 22mm C : 20/22 | |
| Tracteurs étroits <i>Narrow tractors</i> | S.463/6342 (46363423) 1-1 | A : 215 B : 380 C : 20/22 | | | |
| Same 4RM / 4WD Laser, Antares 100, 110, 130 Explorer II 70, 80, 90 Titan 145, 160, 190 | 29/264-6342 (26463424/10) N°970100240 Ø 57mm 1-2 | A : 200 B : 358 D : Ø 20mm | | | |
| Same 2RM / 2WD Explorer II 60, 70, 80, 90, Antares 100 Same 4RM / 4WD Explorer II 70, 80, 90 Vérin standard/ <i>Standart ram cylinder</i> Lamborghini 2RM / 2WD 674, 774, 874, 674-70, 774-70, 874-70 Hürlimann 2RM / 2WD H466, 476, 486, 478, 488 T908, 909, 910-4, 910-6 | S.255/6342 (25563424) N°970440030 Ø 55mm 1-2 | B : 334 D : Ø 20mm | | | |
| Same 4RM / 4WD Explorer II 70, 80, 90 Vérin renforcé/ <i>Heavy duty ram cylinder</i> Lamborghini 4RM / 4WD 674, 774, 874, 674-70, 774-70, 874-70 Hürlimann 4RM / 4WD H466, 476, 486, 478, 488 T908, 909, 910-4, 910-6 | S.448/6342 (44863424) N°980430031 Ø 62mm 1-2 | B : 330 D : Ø 20mm | | | |
| Lamborghini | | | SLT429/6371 (42963713) | E : 295mm Ø : 20mm C : 16/18 | |
| | | | SLT429/6370A (42963704) | E : 300mm Ø : 20mm C : 18/20 | |

(A) : Course / Stroke
(D) : Rotule / Tie rod

(B) : Longueur fermée / Closed length
(E) : Longueur tige / Length shaft

(C) : Cône / Cone

Les références des pièces sont indicatives.
Nos pièces ne sont pas d'origine.

Part numbers are quoted for reference purposes only.
Our parts and accessories are not original.



POMPES HYDRAULIQUES
HYDRAULIC PUMPS

SAME

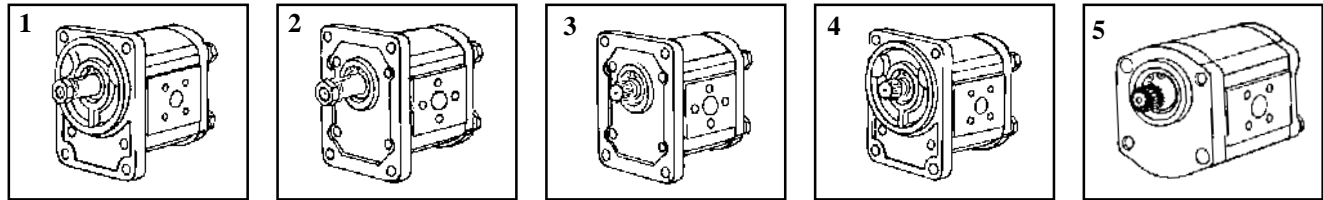

| Tracteurs Tractors | Référence Reference | Fig. Fig. | Type Type | Débit Flow | Rotation Rotation | OEM |
|--|---|--------------|----------------------|----------------------|--|-------------------------------------|
| Antares 100, 110, 130 | BH.515.338 | 5 | DA | 14cc | Gauche LH | 245297900 245299200 |
| Antares 100 | BH.615.023 | | R | 16cc | Droite RH | 245297400 |
| Antares 110, 130 | BH.715.008 | | R | 22,5cc | | 245297800 |
| Centauro 70 exp., Centurion 75 Exp., Condor 55 Jaguar 95 Exp., Leopard 85, Leopard 85 Exp. Mercury 85 Exp., Minitaurus 60 Exp., Taurus 60 Exp. Tiger Six 105 Exp. | BH.425.307 | 1 | DA | 8cc | Gauche LH | 245292700/10 |
| Delfino 35, Falcon 50, Aurora 45, Vigneron 35, 45, 60, Ranger 45 | BH.325.307 BH.425.308 | 4 | | 5,5cc 8cc | | 245292500 |
| Centauro 70SP, Centurion 75SP, Galaxy 170, Laser 90, 100, 110, 130, 150, Leopard 90, 90DT Mercury 85SP | BH.525.024 | 3 | | 11cc | Droite RH | 245294200 |
| Leopard 75C, Trident 130 | 29/4529-430 29/4529-480 BH.525.329 | | 11cc 12cc 14cc | Gauche LH | 24529430, 0510525331 P78120062 24529390 | |
| Explorer 55, 60, 65, 70, 75, 80, 90 | 29/4529-470 | 5 | 8cc | | | 245294700/10 0510415328 |
| Centauro 70SP, 70 Exp., Centurion 75SP, 75 Exp., Mercury 85SP, 85 Exp. | BH.525.329 29/4529-480 BH.625.332 | 3 | R | 14cc 12cc 19cc | Gauche LH | 24529390 P781200GLX 245294000 |
| Laser 90, 100, 110, 130, Galaxy 170, Leopard 90, 90DT, Buffalo 130, Hercule 160, Jaguar 95, Tiger Six 105, Panther 95 | BH.725.348 | | | 22,5cc | | 245293000/10 |
| Explorer 55, 60, 65, 70, 75, 80 | 29/4529-440 | 5 | | 14cc | Droite RH | 0510515013 245294400/10 |
| Explorer II, 80, 90 | BH.615.023 | | | 16cc | | 245297400 |
| Leopard 90 | BH.525.311 SLT.4529/290 | 1 | DA | 11cc | Gauche LH | 245292900 P87120061 |
| Aster 60, 70 | BH.625.315 | | R | 16cc | | |
| Jaguar 100, Trident 130 | BH.625.327 S.4529/330 | 3 | | 16cc 16cc | | 245290160 P781600GLX |
| Buffalo 130 | BH.425.307 BH.525.024 | 1 3 | DA | 8cc 11cc | Gauche/LH Droite/RH | 245292700/10 245294200 |

R : Relevage / Lift
DA : Direction assistée / Power steering

Références "BH..." references : Bosch
Références "29/..." & "SLT..." references : Bendix

Les références des pièces sont indicatives.
Nos pièces ne sont pas d'origine.

Part numbers are quoted for reference purposes only.
Our parts and accessories are not original.



POMPES HYDRAULIQUES
HYDRAULIC PUMPS

LAMBORGHINI

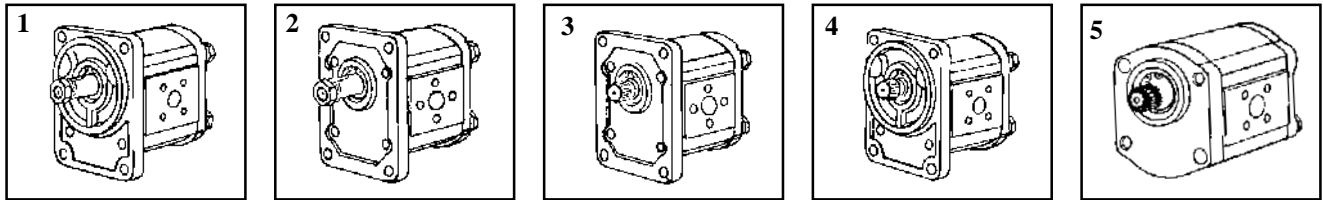

| Tracteurs Tractors | Référence Reference | Fig. Fig. | Type Type | Débit (cc) Flow (cc) | Rotation Rotation | OEM |
|---|---|--------------|--------------|-------------------------|-----------------------|--|
| R.235 (4666 ⇄), 503, 603, 704, A.183 | BH.425.009 | 1 | R | 8 | Droite / RH | 245292800 640R2031 |
| | 29/4529-280 | | | | | P870800D1X |
| 583, 653, 654, 683, 684, 754, 784, 854, 904, 955, A.182 | BH.525.313 | 2 | DA | 11 | Gauche / LH | 245291500 640R2050 |
| 583, 653, 654, 683, 684, 851, 904, 655, 754, 784 | 29/4529-430 | 3 | R | | | 16 |
| 1056, 1156, 1356 (⇄ 1133), 1556 | BH.625.327 S.4529/330 | | | 245293300 P781600G2X | | |
| 956, 1106-1306, 1556, 1706T, 1256, 1356 (1134 ⇄), 3056 | BH.725348 | | | 22,5 | 245293000/10 | |
| 754, 854, 1356 | BH.625.318 | 2 | | 16 | | 245293100 |
| 674, 774, 874 | 29/4529-470 | 5 | DA | 8 | Droite / RH | P650800G2 0510415328 245294700 |
| 674 | 29/4529-440 | | R | 14 | | P651400D2X 0510515013 245294400/10 |
| 774, 874, Formula 105 | BH.615.023 | | | 16 | | 245297400 |
| 956, 1106, 1306, 1506, 1706, R.105 | BH.525.024 | 3 | DA | 11 | | 245294200 |
| 1156, 1356 | BH.625.332 | | R | 19 | 245294000 640R2090 | |
| A.184, 684 | BH.425.307 | 1 | DA | 8 | Gauche / LH | 245292700/10 |
| Formula 115, 135 | BH.515.338 | 5 | | 14 | | 245297900 |
| Racing | 29/4529-480 | 3 | | 12 | | 245294000 |
| Formula 115, 135 | BH.715.008 | 5 | R | 22,5 | Droite / RH | 245297800 |
| 804 | BH.525311 SLT.4529/290 | 1 | | 11 | | 245292900 P871200G1X |
| 956, 1106,1306, 1506, 1706, 1556 | BH.725.331 | 2 | | 22,5 | | |

R : Relevage / Lift

DA : Direction assistée / Power steering

Les références des pièces sont indicatives.
Nos pièces ne sont pas d'origine.

Références "BH..." references : Bosch

Références "29/..." & "SLT..." references : Bendix

Part numbers are quoted for reference purposes only.
Our parts and accessories are not original.



POMPES HYDRAULIQUES
HYDRAULIC PUMPS

HÜRLIMANN

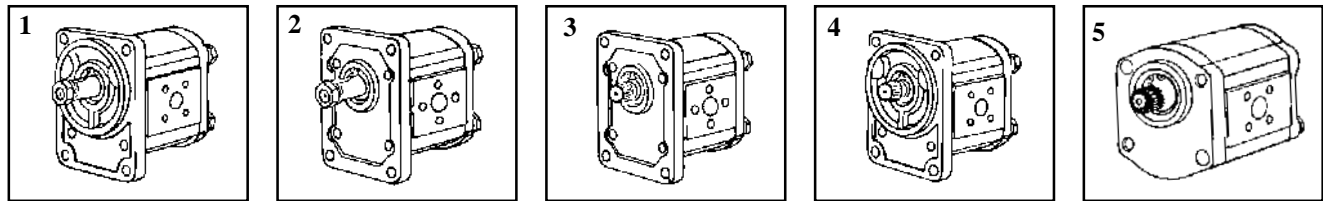

| Tracteurs Tractors | Référence Reference | Fig. Fig. | Type Type | Débit (cc) Flow (cc) | Rotation Rotation | OEM |
|------------------------------------|------------------------|--------------|--------------|-------------------------|----------------------|-------------|
| H.5110 | BH.625.315 | 1 | R | 16 | Gauche / LH | |
| H.6130 | BH.625.317 | 4 | | 16 | | |
| H.6160 | BH.625.316 | | | 19 | | |
| H.6135 | BH.515.338 | 5 | DA | 14 | | 245297900 |
| H.468, H.478, H.488 | BH.615.023 | | | | 16 | Droite / RH |
| H.496, H.5116, H.6136, H.6170 | BH.725.331 | 2 | R | 22,5 | | |
| | BH.725.348 | 3 | | | | |
| H.360, H.470, H.480 | B.525.313 | 2 | | | | 245293600 |
| H.5110, H.360, H.470, H.480, H.490 | BH.525.311 | 1 | DA | 11 | Gauche / LH | Bendix |
| | SLT.4529/290 | | | | | |
| H.490 | BH.525.311 | 1 | R | | | |
| | SLT.4529/290 | | | | | |
| H.496 | BH.525.024 | 3 | DA | | Droite / RH | |
| H.356, H.466, H.478, H.488 | 29/4529-470 | 5 | | 8 | Gauche / LH | 0510415328 |

R : Relevage / Lift

DA : Direction assistée / Power steering

Références "BH..." references

: Bosch

Références "29/..." & "SLT..." references : Bendix

Liste de conversion des anciennes références TRACPIECES

Cross-reference previous TRACPIECES numbers

| Ancienne référence Previous reference | Nouvelle référence New reference | Ancienne référence Previous reference | Nouvelle référence New reference |
|--|-------------------------------------|--|-------------------------------------|
| S.4529/005B | BH.425.308 | S.4529/300 | BH.525.748 |
| S.4529/006S | BH.325.307 | S.4529/016 | BH.625.327 |
| S.4529/009 | BH.425.307 | SLT.4529/570 | BH.425.009 |
| S.4529/015 | BH.525.329 | 27/1740HU | BH.525.313 |
| S.4529/420 | BH.525.024 | SLT.4529/310 | BH.625.318 |

Les références des pièces sont indicatives.
Nos pièces ne sont pas d'origine.

Part numbers are quoted for reference purposes only.
Our parts and accessories are not original.



DISTRIBUTEURS HYDRAULIQUES
HYDRAULIC VALVE

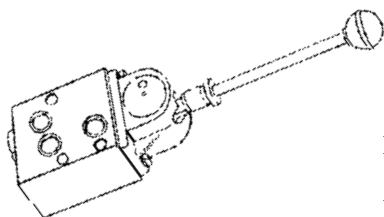

HB.47/SA Simple effet / *single acting*

HB.47/DA Double effet / *double acting*

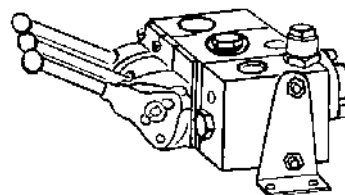

STABILISATEURS
STABILISERS

STABILISATEURSAVEC POSITION FLOTTANTE
STABILISER WITH FLOATING POSITION

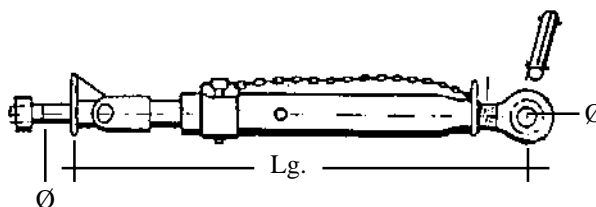

| Réf. Ref. | Lg. fermée Closed Lg. | Lg. ouverte Opened Lg. | Ø Piton Ø Pin | Ø Rotule Ø Tie rod | Flottement Floating | Filetage Thread |
|--------------|--------------------------|---------------------------|------------------|-----------------------|------------------------|--------------------|
| AT.9001/E | 410 | 510 | 18 | 19 | 30 | M27x3 |
| AT.9002/D | 490 | 630 | 28 | | | |
| AT.9003/C | 600 | 710 | | | | |
| AT.9004/B | 580 | 700 | 25 | 40 | M36x3 | |
| AT.9005/A | 680 | 830 | | | | |

STABILISATEUR TYPE ORIGINE
STABILISER GENUINE TYPE

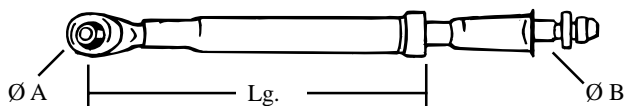

S.9605/426 Lg. : 386mm
ØA : 19mm
ØB : 20mm

S.9605/1506 Lg. : 350mm
ØA : 19mm
ØB : 28mm

GOUPILLE
SAFETY PIN



S.96017/514 Ø 14mm
S.96001/574 Ø 16mm
S.96026/553 Ø 20mm

Les références des pièces sont indicatives.
Nos pièces ne sont pas d'origine.

Part numbers are quoted for reference purposes only.
Our parts and accessories are not original.



TIRANTS DE RELEVAGE
LIFTING RODS

BRAS DE RELEVAGE
LIFT ARM



- S.9605/354** Extrémité droite / *Outside RH*
Leopard, Tiger, Panther
Cat.2, Ø 28
- S.9605/355** Extrémité gauche / *Outside LH*
Leopard, Tiger, Panther
Cat.2, Ø 28

VERIN D'ASSISTANCE DE RELEVAGE
RAM CYLINDER LIFT ARM

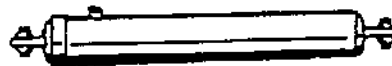

- HYSE.298** Ø tige 40mm / Ø rod 40mm
2 rotules Ø 22mm / 2 tie rods Ø 22mm
Lg. fermée entre-axes : 550mm
Lg. closed : 550mm
Course : 380mm / Stroke : 380mm

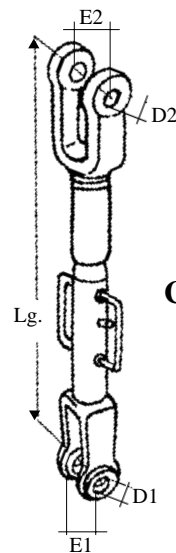
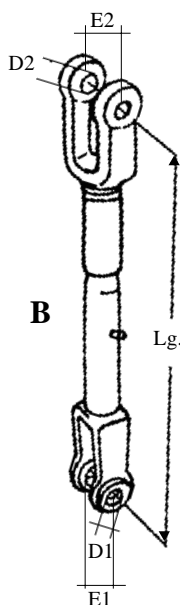
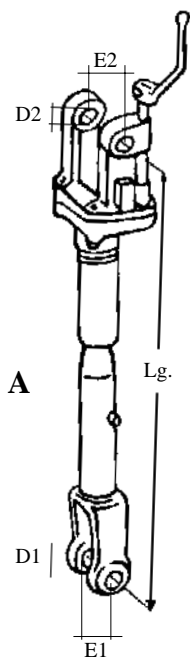

| Réf. Ref. | Description Description | Type Type | L (mm) | D1 Ø (mm) | D2 Ø (mm) | E1 (mm) | E2 (mm) |
|-----------------------------------|---|--------------|-----------|--------------|--------------|------------|------------|
| 29/76057 (76057354) | Tirant réglable / <i>Adjustable rod</i> Explorer 80, 90 + Ancienne gamme / <i>Old range</i> | A | 680 | | | 30 | 45 |
| 29/76036 (76035364) | Tirant fixe / <i>Fixed rod</i> Explorer 60, 70 Lamborghini 874-90DT | B | 645 | 24 | 24 | 25 | 45 |
| 29/76058 (76057364) | Tirant fixe / <i>Fixed rod</i> Explorer 80, 90 | | 680 | | | | |
| 29/96047 (96047364) | Tirant fixe / <i>Fixed rod</i> Laser 110, Antares 110, 130, 150 | | 735 | | | | |
| 29/76039 (*) (76039354) | Tirant gauche ou droit / <i>Rod (LH or RH)</i> Titan 160 | C | 820 | 28 | 28 | 32 | 51 |

(*) Livrable jusqu'à épuisement des stocks / *Stocks in exhaust*

Les références des pièces sont indicatives.
Nos pièces ne sont pas d'origine.

Part numbers are quoted for reference purposes only.
Our parts and accessories are not original.

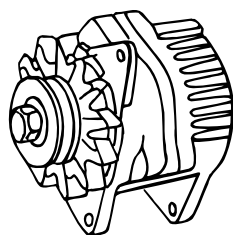

ALTERNATEURS
ALTERNATORS
SAME

| Tracteurs Tractors | Réf. Cde Order N° | Remarques Observations | Capacité Capacity | Régulateur Regulator | OEM |
|---|--|---|--|---|--|
| Falcon, Panther, Buffalo, Minitauro, Saturno | 510.E.385 | Montage à droite <i>RH assembling</i> | 14V., 35 Amp. | Séparé / <i>Separate</i> : 205/01001 | 294390700 9AL2969F |
| Buffalo 130, Centauro 70, Centurion 75, Condor 55, Corsaro, Delfino 35, Drago 120, Falcon, Jaguar 95 & 100, Leopard, Mercury, Panther 90, Taurus 60, Tiger 100, Vigneron 35, 50 & 70 | SLT.9439/090 510.E.414 15/1071 15/1405 (W) | VALEO Raccord à fiches <i>Plug connection</i> Raccord à vis Montage à droite <i>Screw connection</i> <i>RH assembling</i> | 14V., 33 Amp. 14V., 45 Amp. 14V., 55 Amp. 14V., 55 Amp. | 205/01007 505.E.106 205/04034 205/05122 | 294390900 294391300 9AR50066 |
| Antares 100, 110 & 130, Aster 60, Explorer 55, 65, 75 & 85, Centauro 70 & 75, Galaxy, Hercules 60, Jaguar 95 & 100, Laser 90, 100, 110, 130, 150, Leopard 85 & 90, Mercury 85, Panther 95, Taurus 60, Tiger Six 105 | 15/1242 15/8463 (W) 15/1357 (W) 15/1336 (W) | Raccord à vis, Sans poulie <i>Screw connection</i> <i>Without pulley</i> Sans poulie <i>Without pulley</i> Raccord à vis, Poulie double déportée <i>Screw connection</i> <i>Twin pulley (offset)</i> Raccord à vis, Poulie simple <i>Screw connection</i> <i>Single pulley</i> | 14V., 55 Amp. 14V., 65 Amp. 14V., 65 Amp. 14V., 55 Amp. | 205/05122 205/05122 205/04034 205/04034 | 294391300 294392900 |
| Solar, Titan, Explorer, Antares | 15/5514 | Pour chauffage Sans poulie <i>For heating</i> <i>Without pulley</i> | 14V., 65 Amp. | Sans régulateur <i>Less regulator</i> Séparé / <i>Separate</i> : 16.906.339 | |
| Corsaro 70, Panther 90, Leopard 85, Saturno 80, Tiger 100 | 15/1405 (W) | Raccord à vis <i>Screw connection</i> | 14V., 55 Amp. | 205/05122 | 9AR2968K |
| Silver 80, 90, 100-4, 100-6 | 15/1667 | Pour chauffage Rotation gauche <i>For heating</i> <i>LH rotation</i> | 14V., 85 Amp. | AER1606 | 294394700 |
| Ancien montage <i>Old Assembly</i> | 510.E.384 15/1309 (W) | VALEO Axe/ <i>Shaft</i> : Ø 17mm | 14V., 50 Amp. 14V., 55 Amp. | 505.E.079 205/05122 | |

 (W) Raccordement électrique du compteur / *Electrical tachometer connection*

 Les références des pièces sont indicatives.
 Nos pièces ne sont pas d'origine.

 Part numbers are quoted for reference purposes only.
 Our parts and accessories are not original.

ALTERNATEURS
ALTERNATORS

LAMBORGHINI

| Tracteurs Tractors | Réf. Cde Order N° | Remarques Observations | Capacité Capacity | Régulateur Regulator | OEM |
|---|----------------------|---|----------------------|-------------------------|-----------|
| 360, 483 | 15/1995 | | 14V., 33 Amp. | 205/01007 | |
| 503, 603, 704, 804, 904 | K.552 (W) | | 14V., 33 Amp. | 205/01007 | |
| 553, 653, 654, 683, 684, 754, 784, 854 | SLT.9439/090 | | 14V., 33 Amp. | 205/01007 | 294390900 |
| 674, 774, 874, 956, 1106, 1156, 1256, 1306, 1356, 1506, 1706 | 15/1242 | Raccord à fiches <i>Plug connection</i> | 14V., 55 Amp. | 205/05122 | 294391300 |
| | 15/8463 (W) | Sans poulie <i>Less pulley</i> | 14V., 65 Amp. | 205/05122 | |
| | 15/1357 (W) | Raccord à fiches <i>Plug connection</i> Poulie double déportée <i>Twin pulley (offset)</i> | 14V., 65 Amp. | 205/04034 | |

HÜRLIMANN

| Tracteurs Tractors | Réf. Cde Order N° | Remarques Observations | Capacité Capacity | Régulateur Regulator | Réf. OEM Ref. OEM |
|---|--------------------------------------|-----------------------------------|--------------------------------|--------------------------------------|----------------------|
| H356, 466, 466-4, 476, H486T, 6170T, 6670, 6680, 6690, 8610, 8630 | 15/1242 15/8463 (W) | Sans poulie <i>Less pulley</i> | 14V., 55 Amp. 14V., 65 Amp. | 205/05122 205/05122 | |

(W) Raccordement électrique du compteur / *Electrical tachometer connection*

PIECES DIVERSES POUR DYNAMO "BOSCH"
MISCELLANEOUS PARTS FOR "BOSCH" GENERATOR

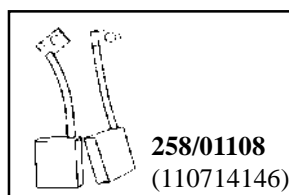
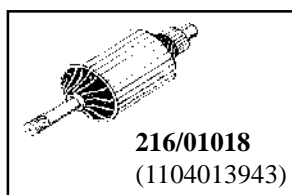

PIECES DIVERSES POUR ALTERNATEURS D'ORIGINE
MISCELLANEOUS PARTS FOR ORIGINAL ALTERNATORS

Balai / *Brushe*

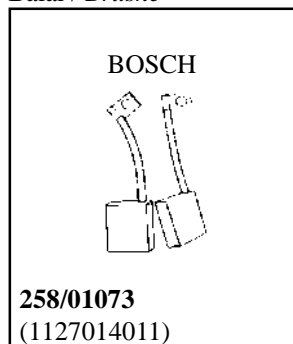

Bloc balai / *Brushe set*

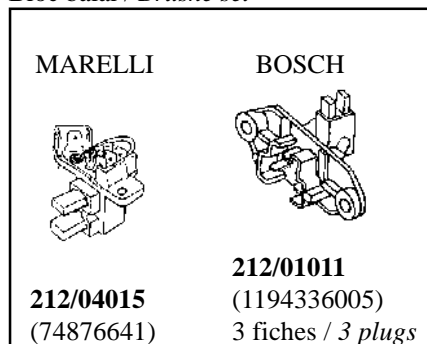

Régulateur / *Control box*

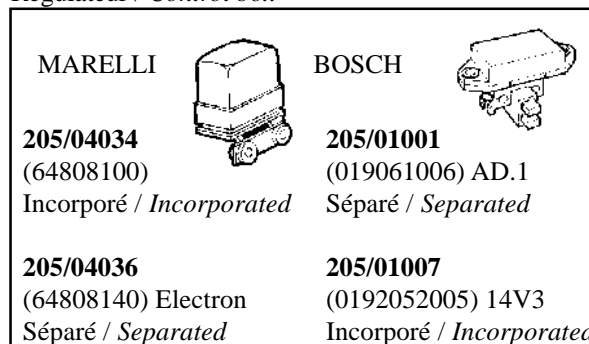

Les références des pièces sont indicatives.
Nos pièces ne sont pas d'origine.

Part numbers are quoted for reference purposes only.
Our parts and accessories are not original.

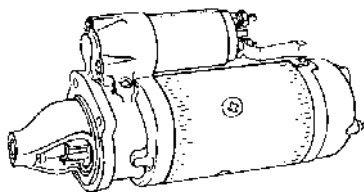

DEMARREURS
STARTER MOTORS

SAME

| Tracteurs Tractors | Réf. Cde Order N° | Lanceur Drive ass. | Fixation Fitting | Lg. sortante Prominent lg. | Capacité Capacity | OEM |
|--|----------------------|-----------------------|---------------------|-------------------------------|----------------------|-----------|
| Antares 110, 130 & 150, Explorer 80 & 90, Galaxy 170, Laser 110, 130 & 150 (Certains / Some) | S.9619/180N | 9Z | 2L | 254mm | 12V., 3,5 KW | 296192300 |
| Minitauro 55/60, Corsaro 70, Delfino, Explorer 60, Falcon, Aurora, Saturno | S.9619/080 | 11Z | 2L | 224mm | 12V., 1,8 KW | 296190800 |
| Antares 110 & 130, Drago 120, Buffalo 130, Centauro 70, Centurion 75, Condor 55, Corsaro 70, Explorer 55, 65, 75 & 85, Galaxy 170, Herculus 160, Jaguar 95 & 100, Laser 90, 110, 130, 150 (3/83 ⇄ 12/87) Leopard 85 & 90, Mercury 85, Minitauro 60, Minitaurus 60, Panther 90 & 95, Saturno 80, Solar 60, Taurus 60, Tiger 100, Tiger Six 105, Titan 160 & 190 | SLT.9619/110 | 11Z | 2L | 254mm | 12V., 3,5 KW | 296191800 |

LAMBORGHINI

| Tracteurs Tractors | Réf. Cde Order N° | Lanceur Drive ass. | Fixation Fitting | Lg. sortante Prominent lg. | Capacité Capacity | OEM |
|--|----------------------|-----------------------|---------------------|-------------------------------|----------------------|-----------|
| 503, 603 (3/71 ⇄) | SLT.2040 | 9Z | 2L | 228mm | 12V., 2,7 KW | |
| 235, 653, 784 | S.9619/080 | 11Z | 2L | 224mm | 12V., 1,8 KW | 296190800 |
| 804, 904 | SLT.073 | 9Z | 3L | 262mm | 12V., 3 KW | 296195000 |
| 235, 345, 503, 603, 613, 653, 654, 674, 684, 704, 714, 754, 774, 784, 804, 854, 874, 955, 1056, 1156, 1256, 1556, 574-60, 874-90, 674-70, 774-80 | SLT.9619/110 | 11Z | 2L | 254mm | 12V., 3,5 KW | 296191800 |
| 503, 603, 1106, 1306, 1506, 1706, 1356, 674-70, 774-80, 874-90 Formula 115, 135 | S.9619/180N | 9Z | 2L | 254mm | 12V., 3,5 KW | 296192300 |

HÜRLIMANN

| Tracteurs Tractors | Réf. Cde Order N° | Lanceur Drive ass. | Fixation Fitting | Lg. sortante Prominent lg. | Capacité Capacity | OEM |
|---|----------------------|-----------------------|---------------------|-------------------------------|----------------------|-----------|
| H355, 360, H470, 480, 490, H5110, H6110, H476U, H488T, 496T, 5116T, 6115, 6130, 6135, 6136, 6160, 6165, 6190 | SLT.9619/110 | 11Z | 2L | 254mm | 12V., 3,5 KW | 296191800 |
| 356, 468, 478, H468-70, 468L, LA, B, H468-80, 488-90, 5116, 6170T, 6136 | S.9619/180N | 9Z | 2L | 254mm | 12V., 3,5 KW | 296192300 |

Les références des pièces sont indicatives.
Nos pièces ne sont pas d'origine.

Part numbers are quoted for reference purposes only.
Our parts and accessories are not original.

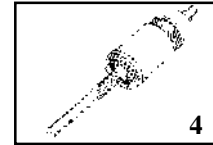
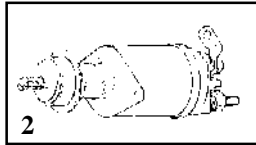
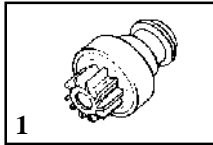

PIECES DE RECHANGE POUR DEMARREURS "BOSCH"
SPARE PARTS FOR "BOSCH" STARTER MOTORS

| Figures | | 1 | 2 | 3 | 4 |
|---|--------------------------------|----------------------------------|----------------------------------|-----------------------------------|----------------------------------|
| Tracteurs Tractors | Démarrreur Starter motor | Lanceur Drive ass. | Relais Solenoid | Jeu de balais Brushes | Induit Armature |
| Ariete, Drago (11/71 ⇄ 2/73) | 0.00.1359.013 | 224/01061 (2006209301) | 203/01056 (0331401001) | 258/01056B (2007014052) | |
| Atlanta, Centauro, Delfino, Italia Minitauro (1/72 ⇄ 12/73), Sametto | 0.00.1362.099 0.00.1362.009 | 224/01122 (2006209245) | 203/01063 (0331401032) | 258/01058 (2007014053) | 220/01048 (2004004072) |
| Aurora (11/71 ⇄ 2/73), Corsaro (2/72 ⇄ 6/76), Falcon 983L Saturno (3/72 ⇄ 6/76) | 0.00.1362.022 | | | | 220/01034 (2004004061) |
| Aurora (3/73 ⇄), Centurion (9/78 ⇄) Condor (2/79 ⇄), Corsaro (7/76 ⇄) Delphino (1/72 ⇄ 9/80) Falcon (7/75 ⇄ 9/80), Jaguar Leopard (1/78), Minitauro (⇄ 9/80) Panther (2/79 ⇄), Saturno (7/76 ⇄) Sirenetta (1/72 ⇄), Taurus (11/78 ⇄) C.352, 553, 653, 503 (7/76 ⇄) 784 (1/80 ⇄) | 0.00.1362.035 | 224/01269 (200620475) | 203/01065 (0331402003) | 258/01059 (2007014057) | 220/01059 (2004004074) |
| Buffalo (7/74 ⇄ 1/75) Drago (3/73 ⇄ 1/75) Panther (7/74 ⇄ 1/75) C.603, R.704, 804, 904 (73/75) | 0.00.1359.053 | 224/01189 (2006209408) | 203/01057 (0331401004) | 258/01056B (2007014052) | |
| Buffalo (2/75 ⇄ 7/79) Drago (2/75 ⇄ 7/79) Panther (2/75 ⇄ 7/79) C.603, R.704, 804, 904 (75/78) R.1056, 955 | 0.00.1359.099 0.00.1359.108 | 224/01134 (2006209438) | 203/01069 (0331402002) | | |
| Leone (1/67 ⇄ 12/71) C.603, R.704, 804, 904 (4/73 ⇄ 10/73) 955 | 0.00.1359.004 | 224/01058 (2006209302) | 203/01056 (0331401001) | | |
| R.503, 603 (3/71 ⇄) | 0.00.1362.040 | 224/01149 (2006209476) | 203/01064 (0331402001) | 258/01059 (2007014057) | |
| R.1256 (6/78 ⇄), R.955, R.1056 | 0.00.1367.005 | 224/01150 (2006209492) | 203/01069 (0331402002) | 258/01062 (2007014062) | |

Les références des pièces sont indicatives.
Nos pièces ne sont pas d'origine.

Part numbers are quoted for reference purposes only.
Our parts and accessories are not original.



DIVERS
MISCELLANEOUS

**LA MEILLEURE
PEINTURE DU MARCHE**



64/LA.2036/L
64/LA.1004/L

Bleu foncé / *Drak blue* - Lamborghini
Blanc avorio / *Avorio white* - Lamborghini

64/LA.2034/L
64/LA.2034/SP
64/LA.3034/L
64/LA.3034/SP
64/LA.6034/L
64/LA.6034/SP

Bleu / *Blue* - Same
Bleu / *Blue* - Same
Orange / *Orange* - Same
Orange / *Orange* - Same
Gris châssis / *Chassis grey* - Same
Gris châssis / *Chassis grey* - Same

**THE BEST PAINT ON
THE MARKET**

(1 litre / 1 liter)
(1 litre / 1 liter)

(1 litre / 1 liter)
(Spray)
(1 litre / 1 liter)
(Spray)
(1 litre / 1 liter)
(Spray)



**SIGLE
MEDALLION**



29/174006

Ø 80,5mm
Plastique / *Plastic*

61/830-301

(Ex : 1050/BON)



SIEGE COMPLET / COMPLETE SEAT

Caractéristiques techniques

- Modèle spécial pour les montages où l'espace arrière est limité
- Réglage en hauteur
- Glissières
- Revêtement synthétique noir

Technical data

- *Special model to fit where rear space is limited*
- *Height adjustment*
- *Slide rails adjustment*
- *Synthetic black leather*

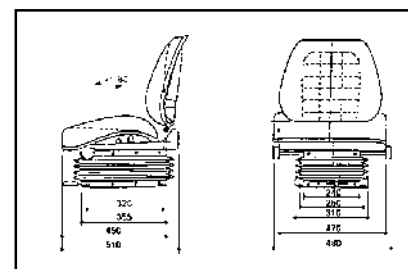

**REGARNITURES DE SIEGES
SEAT TRIMS**



S.157/751H

Siège Grammer
Seat Grammer

S.165/7518H

Siège Bostrom
Seat Bostrom

Les références des pièces sont indicatives.
Nos pièces ne sont pas d'origine.

Part numbers are quoted for reference purposes only.
Our parts and accessories are not original.



ELEMENTS DE CABINES
CABS ELEMENTS

RACLETTES D'ESSUIE-GLACE
WIPER BLADES



10/3223 Balai assemblé / Wiper blade
Lg. : 400-410mm

10/3225 Balai assemblé / Wiper blade
Lg. : 450-460mm

MOTEUR D'ESSUIE-GLACE
WIPER MOTOR

ET.12032

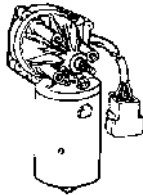

R/404A

SUPPORT DE RETROVISEUR
MIRROR BRACKET

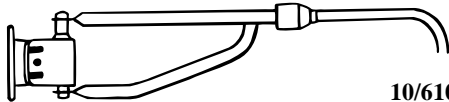

10/6100K
(0083741437429)

Support extensible pour rétroviseur (Gauche ou droit)
Sans cuvette
Extensible bracket for mirror (LH or RH)
Less mirror

RETROVISEURS
REAR VIEW MIRRORS

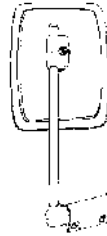

29/9234.147 Rétroviseur droit
Mirror RH



29/9234.149 Rétroviseur gauche
Mirror LH

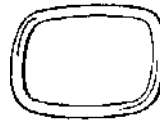

29/9233.183 Cuvette 237x180mm
Mirror 237x180mm

29/9200.147 Cuvette 354x169mm
Mirror 354x169mm

PIECES DE PORTE DE CABINE
DOOR PARTS CAB

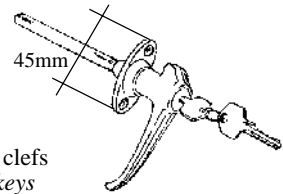

6734 - Poignée avec clefs
(92001726/10) Handle with keys
Cabine "SIAC" Cab

6821 - Poignée intérieure
(9200158020) Inner handle
Cabine "SIAC" Cab

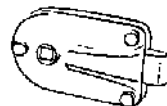

29/9200-156 - Serrure droite
Lock (RH)

29/9200-155 - Serrure gauche
Lock (LH)



ETAIS A GAZ
GAS STRUTS

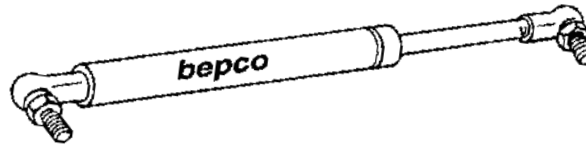

SAME

| Tracteurs Tractors | Pare-brise Windscreen | Porte Door | Toit Roof | Vitre arrière Rear glas |
|-------------------------------|--------------------------------------|-------------------------------------|-------------------------------------|-------------------------------------|
| Antares, Titan | 29/9206-194 (9200.170.3) 255mm | 29/872-23 (00820894/20) 390mm | SLT.9234/373 320mm | 29/872-37 (00754070) 715mm |
| Aster | | | | SLT.9208/140 515mm - 350 Newtons |
| Centaurus | | S.9206/194 500mm | S.9206/194 500mm - 220 Newtons | |
| Centurion, Leopard Buffalo | | SLT.9241/140 (92411404) 500mm | | SLT.9234/373 320mm |
| Explorer | | | 29/870-38 (92061984/10) | |
| Explorer II, 60, 70, 80, 90 | | SLT.9233/167 502mm - 230 Newtons | | |
| Galaxy | | | SLT.9233/167 502mm - 230 Newtons | |
| Hercules | | | | |
| Jaguar | | SLT.9208/140 515mm - 350 Newtons | | |
| Laser | | SLT.9234/373 320mm | SLT.9233/167 502mm - 230 Newtons | |
| Solar | | | | |
| Taurus | | SLT.9208/140 515mm - 350 Newtons | SLT.9241/140 500mm | S.9206/194 500mm - 220 Newtons |
| Tiger, Trident | | SLT.9208/140 515mm - 350 Newtons | | |

Les références des pièces sont indicatives.
Nos pièces ne sont pas d'origine.

Part numbers are quoted for reference purposes only.
Our parts and accessories are not original.



ETAIS A GAZ
GAS STRUTS

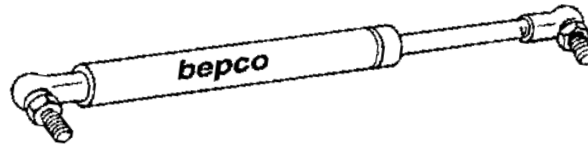

LAMBORGHINI

| Tracteurs Tractors | Pare-brise Windscreen | Porte Door | Toit Roof | Vitre arrière Rear glas |
|--|---------------------------------------|---------------------------------------|-----------------------|---|
| R.674, R.874 | SLT.9241/140 (9233.166.4) 500mm | SLT.9241/140 (9233.166.4) 500mm | SLT.9234/373 320mm | SLT.9241/140 (9233.166.4) 500mm - 200 Newtons |
| R.956, R.1106, R.1306, R.1506 | | | | |
| R.774 | | | | SLT.9233/167 502mm - 230 Newtons |
| R.774-80, R.874T | | | | |
| R.874-90T, R.874-90T Grand Prix, 105 Formula | | SLT.9241/140 (9233.166.4) 500mm | | |
| Hürlimann XT Lamborghini Premium | | 29/872-23 (00820894/20) 390mm | | 29/872-37 (00754070) 715mm |

HÜRLIMANN

| Tracteurs Tractors | Pare-brise Windscreen | Porte Door | Toit Roof | Vitre arrière Rear glas |
|--|--------------------------|---|-----------------------|---|
| H356, H358, H466 H476, H468, H478, H488 | | SLT.9241/140 (92411404) 500mm | SLT.9234/373 320mm | 29/872-38 (92061984/10) 520mm - 200 N |
| 490, 5110, 480 | | | | |
| XT | | | | 29/872-37 (00754070) 700mm - 350 N |
| 6115, 6135 | | 29/872-23 (00820894/20) 385mm - 570 N | | |

Les références des pièces sont indicatives.
Nos pièces ne sont pas d'origine.

Part numbers are quoted for reference purposes only.
Our parts and accessories are not original.



BAGUES D'ETANCHEITE
OIL SEALS

| Dimensions Ø Dimensions Ø | Réf. SAME Ref. SAME | Type Type | Réf. Ref. | Dimensions Ø Dimensions Ø | Réf. SAME Ref. SAME | Type Type | Réf. Ref. |
|------------------------------|--|--------------|--------------------|------------------------------|--|--------------|--------------------|
| 12x20x7 | 2.1519.042.0 | | 29/1519.042 | 58x80x10 | 2.1519.001.0 (2.1519.010.0) | SP | 29/1519.010 |
| 30x40x7 | 2.1510.013.0 | | 29/1510.013 | 58x80x10 | 2.1520.130.0 | 2 | 29/1520.130 |
| 34x52x10/13 | 2.1510.216.0 (2.1520.116.0) (2.1529.010.0) | 3 | 29/1510.216 | 60x75x8 | 2.1510.031.0 (2.1520.131.0) | 2 | 29/1520.131 |
| 34x46x10 | 2.1529.021.0 | 3 | 29/1529.021 | 65x85x10 | 2.1510.331.0 | | 29/1510.331 |
| 35x47x7 | 2.1510.017.0 | | 29/1510.017 | 60x80x10 | 2.1520.231.0 | 2 | 29/1520.231 |
| 35x62x10 | 2.1510.617.0 (2.1529.030.0) | 3 | 29/1510.617 | 70x85x8 | 2.1510.036.0 | | 29/1510.036 |
| 35x62x12 | 2.1520.217.0 | 2 | 29/1520.217 | 70x90x10/12 | 2.1510.136.0 (2.1520.036.0) (2.1529.004.0) | 3 | 29/1529.004 |
| 35x72x12 | 2.1520.317.0 | 2 | 29/1520.317 | 70x100x10 | 2.1520.336.0 | 2 | 29/1520.336 |
| 35x55x10 | 2.1529.033.0 | 3 | 29/1529.033 | 70x100x12 | 2.1529.026.0 | 3 | 29/1529.026 |
| 38x50x7 | 2.1510.019.0 | | 29/1510.019 | 70x90x12/9,5 | 2.1529.072.0 | 3 | 29/1529.072 |
| 38x52x7 | 2.1510.119.0 | | 29/1510.119 | 80x100x10/13 | 2.1510.041.0 (2.1529.005.0) (2.1520.141.0) | 3 | 29/1520.141 |
| 40x56x8 | 2.1510.120.0 | | 29/1510.120 | 85x110x12 | 2.1529.501.0 (2.1520.043.0) | 2 | 29/1529.501 |
| 40x80x10 | 2.1520.420.0 | 2 | 29/1520.420 | 95x120x13 | 2.1510.447.0 | | 29/1510.447 |
| 40x68x10/13 | 2.1529.016.0 | 3 | 29/1529.016 | 98x120x13 | 2.1519.002.0 (2.1519.009.0) | SP | 29/1519.009 |
| 42x56x7 | 2.1510.021.0 | | 29/1510.021 | 100x120x12 | 2.1510.049.0 (2.1520.049.0) | 2 | 29/1520.049 |
| 42x60x10 | 2.1510.221.0 | | 29/1510.221 | 100x125x12 | 2.1510.149.0 (2.1529.013.0) | 3 | 29/1529.013 |
| 45x62x10 | 2.1510.123.0 (2.1520.023.0) | 2 | 29/1520.023 | 110x140x13 | 2.1529.056.0 | | 29/1529.056 |
| 45x65x10 | 2.1510.223.0 (2.1520.123.0) (2.1529.031.0) | 3 | 29/1529.031 | 110x130x13 | 2.1529.073.0 | 3 | 29/1529.073 |
| 45x62x10 | 2.1529.036.0 (2.1529.029.0) | 3 | 29/1529.036 | 125x150x13 | 2.1529.040.0 | 3 | 29/1529.040 |
| 45x62x16 | 2.1529.078.0 | 3 | 29/1529.078 | 130x160x12 | 2.1510.055.0 | 3 | 29/1510.055 |
| 48x62x8 | 2.1510.025.0 | | 29/1510.025 | 135x160x15 | 2.1529.023.0 | 3 | 29/1529.023 |
| 50x72x10/8 | 2.1510.426.0 | | 29/1510.426 | 145x180x15 | 2.1529.006.0 (2.1529.064.0) | 3 | 29/1529.064 |
| 50x68x10 | 2.1520.026.0 | 2 | 29/1520.026 | 145x170x13 | 2.1529.038.0 | 3 | 29/1529.038 |
| 50x72x10 | 2.1529.041.0 | 3 | 29/1529.041 | 150x180x15 | 2.1529.065.0 (2.1529.002.0) | 3 | 29/1529.065 |
| 55x72x12 | 2.1510.129.0 (2.1520.329.0) (2.1529.032.0) | 3 | 29/1529.032 | 180x205x23 | 2.1529.081.0/20 | 3 | 29/1529.081 |
| 55x80x10 | 2.1529.022.0 | 3 | 29/1529.022 | 240x270x25 | 2.1529.069.0 | 3 | 29/1529.069 |

 (2) Double lèvre / *Twin lip*

 (3) Triple lèvre, carcasse acier / *Triple lip, steel armature*

 (SP) Spécial / *Special*

 Les références des pièces sont indicatives.
 Nos pièces ne sont pas d'origine.

 Part numbers are quoted for reference purposes only.
 Our parts and accessories are not original.